

**LEVEL**

*D*  
*nu*

SDO-1600  
(Revised)

AD A066299

DDC FILE COPY

# ARTIFICIAL EARTH SATELLITES

DESIGNED AND FABRICATED

by

**THE JOHNS HOPKINS UNIVERSITY  
APPLIED PHYSICS LABORATORY**

PREPARED

by

THE SPACE DEPARTMENT

DDC  
MAR 26 1979  
C

ORIGINAL OF THIS DOCUMENT IS FILED IN DDC  
REPRODUCTIONS AVAILABLE FOR \$0.50 PER COPY AND WHITE.

THE JOHNS HOPKINS UNIVERSITY ■ APPLIED PHYSICS LABORATORY  
Johns Hopkins Road, Laurel, Maryland 20810  
Operating under Contract N00024-78-C-5384 with the Department of the Navy

Approved for public release; distribution unlimited.

79 03 22 074

REPORT DOCUMENTATION PAGE

1. REPORT NUMBER APL/JHU/SDO-1600-REV		2. GOVT ACCESSION NO	3. RECIPIENT'S CATALOG NUMBER
4. TITLE (and Subtitle) Artificial Earth Satellites Designed and Fabricated by The Johns Hopkins University Applied Physics Laboratory. <i>R. ...</i>		5. TYPE OF REPORT & PERIOD COVERED Status Report, 1959 to date - 1978.	6. PERFORMING ORG. REPORT NUMBER APL/JHU SDO-1600
7. AUTHOR(s) Space Department		8. CONTRACT OR GRANT NUMBER(s) N00024-78-C-5384	9. PERFORMING ORGANIZATION NAME & ADDRESS The Johns Hopkins University Applied Physics Laboratory Johns Hopkins Road Laurel, Maryland 20810
11. CONTROLLING OFFICE NAME & ADDRESS Naval Plant Representative Office Johns Hopkins Road Laurel, Maryland 20810		10. PROGRAM ELEMENT, PROJECT, TASK AREA & WORK UNIT NUMBERS Task Y22	12. REPORT DATE July 1978
14. MONITORING AGENCY NAME & ADDRESS Naval Plant Representative Office Johns Hopkins Road Laurel, Maryland 20810		13. NUMBER OF PAGES 235	15. SECURITY CLASS. (of this report) Unclassified
16. DISTRIBUTION STATEMENT (of this Report) Approved for public release; distribution unlimited		15a. DECLASSIFICATION/DOWNGRADING SCHEDULE N/A	
17. DISTRIBUTION STATEMENT (of the abstract entered in Block 20, if different from Report) N/A		18. SUPPLEMENTARY NOTES	
19. KEY WORDS (Continue on reverse side if necessary and identify by block number) Army, Navy, NASA, Air Force (ANNA) Satellite -1A and -1B (1962 Beta Mu 1); Disturbance Compensation System (DISCOS); Direct Measurement Explorer (DME) Satellite -A (1965 98B); Department of Defense Gravity Experiment (DODGE) Satellite (1967 66F);			
20. ABSTRACT (Continue on reverse side if necessary and identify by block number) Satellites designed and fabricated by the Applied Physics Laboratory of The Johns Hopkins University since the inception of the space program at APL in 1957 are described. The descriptions, including artist's concepts and other illustrations, are arranged in chronological order according to primary mission category. Satellite categories include navigation satellites (Transit, TRIAD, TIP, TRANSAT, etc.), geodetic research satellites (ANNA, GEOS, LIDOS, etc.), orbital environment and dynamics research satellites (TRAAC, 5E-series, DODGE), ionospheric research satellites (Beacon and Direct Measurement Explorers, P76-5), and astronomical exploration satellites (Small Astronomy Satellites). Appendixes include a functional description of the Navy Navigation Satellite System and several bibliographies. This report is updated from time to time with the issuance of new and revised material, and is one of a series that includes APL/JHU SDO-3100, "Navy Navigation Satellite System User Equipment Handbook" and APL/JHU SDO-4100, "Instrumentation Developed by APL/JHU for Non-APL Spacecraft."			

DD FORM 1 JAN 73 1473

Unclassified

031-30 79 08 22 074 LB

19. KEY WORDS (continued)

Geodetic Earth Orbiting Satellite (GEOS)-A (1965 89A) and -B (1968 02A);  
 Geodynamics Experimental Ocean Satellite (GEOS)-C (1975 27A);  
 Low Inclination Doppler Only Satellite (LIDOS);  
 Navigation Satellite (NAVSAT);  
 Navy Navigation Satellite System (NNSS);  
 Orbit Adjust and Transfer System (OATS);  
 Oscar Satellite;  
 Small Astronomy Satellite (SAS) -A (1970 107A), -B (1972 91A), and -C (1975 37A);  
 Transit Improvement Program (TIP) Satellite;  
 Transit Research and Attitude Control (TRAAC) Satellite (1961 Alpha Eta 2);  
 TRIAD Satellite (1972 69A);  
 Translator Satellite (TRANSAT);  
 Satellite Tracking (SATRACK) System;  
 1-A Satellite;  
 1-B Satellite (1960 Gamma 2);  
 2-A Satellite (1960 Eta 1);  
 3-A Satellite;  
 3-B Satellite (1961 Eta 1);  
 4-A Satellite (1961 Omicron 1);  
 4-B Satellite (1961 Alpha Eta 1), 5A-1 (1962 Beta Psi 2), -2, and -3 (1963 22A) Satellites;  
 5BN-1 (1963 38B), -2 (1963 49B), and -3 Satellites;  
 5C-1 Satellite (1964-26A);  
 5E-1 (1963 38C), -2, -3 (1963 49C) and -5 (1964 83C) Satellites;  
 P76-5 Satellite (1976 47A);  
 Navigation Satellites;  
 Geodetic Research Satellites;  
 Orbital Environment and Dynamics Research Satellites;  
 Ionospheric Research Satellites;  
 Astronomical Research Satellites;  
 0-4 (1965 48C);  
 0-6 (1965 109A);  
 0-8 (1966 24A);  
 0-10 (1966 76A);  
 0-12 (1967 34A);  
 0-13 (1967 48A);  
 0-14 (1967 92A);  
 0-11/TRANSAT (1977 106A)

SEARCHED	INDEXED
SERIALIZED	FILED
BY DISTRICT CLERK DIS.	
A	

CONTENTS

	Page
List of Illustrations . . . . .	ix
List of Tables . . . . .	xiii
Introduction . . . . .	1
Historical Note . . . . .	7
 I. NAVIGATION SATELLITES	
Satellite 1-A . . . . .	I-1
Background . . . . .	I-3
Physical Characteristics . . . . .	I-3
Features . . . . .	I-3
Objectives . . . . .	I-5
Achievements . . . . .	I-5
 Satellite 1-B . . . . .	 I-7
Physical Characteristics . . . . .	I-9
Features . . . . .	I-9
Objectives . . . . .	I-9
Achievements . . . . .	I-11
 Satellite 2-A . . . . .	 I-13
Physical Characteristics . . . . .	I-15
Features . . . . .	I-15
Objectives . . . . .	I-15
Achievements . . . . .	I-17
 Satellite 3-A . . . . .	 I-19
Physical Characteristics . . . . .	I-21
Features . . . . .	I-21
Objectives . . . . .	I-21
 Satellite 3-B . . . . .	 I-23
Physical Characteristics . . . . .	I-25
Features . . . . .	I-25
Objectives . . . . .	I-27
Achievements . . . . .	I-27

CONTENTS (Continued)

	Page
Satellites 4-A and 4-B . . . . .	I-29
Background . . . . .	I-31
Physical Characteristics . . . . .	I-31
Features . . . . .	I-32
Objectives . . . . .	I-32
Achievements . . . . .	I-32
Satellite 5A Series . . . . .	I-39
(5A-1, 5A-2, and 5A-3)	
Background . . . . .	I-41
Physical Characteristics . . . . .	I-42
Features . . . . .	I-42
Objectives . . . . .	I-42
Achievements . . . . .	I-45
Satellite 5BN Series . . . . .	I-47
(5BN-1, 5BN-2, and 5BN-3)	
Background . . . . .	I-49
Physical Characteristics . . . . .	I-49
Features . . . . .	I-50
Objectives . . . . .	I-50
Achievements . . . . .	I-50
Satellite 5C-1 . . . . .	I-55
Physical Characteristics . . . . .	I-57
Features . . . . .	I-57
Objectives . . . . .	I-60
Achievements . . . . .	I-60
Oscar Satellite Series . . . . .	I-61
(Oscars 4, 6, and 8-14)	
Background . . . . .	I-64
Physical Characteristics . . . . .	I-64
Features . . . . .	I-64
Objective . . . . .	I-69
Achievements . . . . .	I-69
TRIAD Satellite . . . . .	I-71
Background . . . . .	I-73
Physical Characteristics . . . . .	I-73
Features . . . . .	I-73
Objectives . . . . .	I-77
Achievements . . . . .	I-78

R

CONTENTS (Continued)

	Page
TIP-II and -III Satellites . . . . .	I-81
Background . . . . .	I-83
Physical Characteristics . . . . .	I-83
Features . . . . .	I-84
Objective . . . . .	I-88
Achievements . . . . .	I-88
Translator Satellite (TRANSAT) . . . . .	I-91
Background . . . . .	I-93
Description . . . . .	I-93
Physical Characteristics . . . . .	I-96
Features . . . . .	I-96
Objectives . . . . .	I-99
Achievements . . . . .	I-99
II.    GEODETTIC RESEARCH SATELLITES	
ANNA-1A and -1B Satellites . . . . .	II-1
Background . . . . .	II-3
Physical Characteristics . . . . .	II-3
Features . . . . .	II-3
Objectives . . . . .	II-6
Achievements . . . . .	II-6
GEOS-A and -B Satellites . . . . .	II-9
Background . . . . .	II-11
Physical Characteristics . . . . .	II-11
Features . . . . .	II-11
Geodetic Instrumentation . . . . .	II-14
Objectives . . . . .	II-15
Achievements . . . . .	II-15
LIDOS Satellite . . . . .	II-17
Background . . . . .	II-19
Physical Characteristics . . . . .	II-19
Features . . . . .	II-19
Objectives . . . . .	II-20
Achievements . . . . .	II-20
GEOS-C Satellite . . . . .	II-23
Background . . . . .	II-25
Physical Characteristics . . . . .	II-25
Features . . . . .	II-25
Objectives . . . . .	II-28
Achievements . . . . .	II-30

CONTENTS (Continued)

	Page
<b>III. ORBITAL ENVIRONMENT AND DYNAMICS RESEARCH SATELLITES</b>	
TRAAC Satellite . . . . .	III-1
Background . . . . .	III-3
Physical Characteristics . . . . .	III-3
Features . . . . .	III-3
Objectives . . . . .	III-5
Achievements . . . . .	III-5
Satellite 5E Series . . . . .	III-7
(5E-1, 5E-2, 5E-3, and 5E-5)	
Background . . . . .	III-9
Physical Characteristics . . . . .	III-9
Features . . . . .	III-10
Objectives . . . . .	III-16
Achievements . . . . .	III-18
DODGE Satellite . . . . .	III-23
Background . . . . .	III-25
Physical Characteristics . . . . .	III-25
Features . . . . .	III-25
Objectives . . . . .	III-28
Achievements . . . . .	III-28
<b>IV. IONOSPHERIC RESEARCH SATELLITES</b>	
Beacon Explorer Satellites . . . . .	IV-1
(BE-A, BE-B, and BE-C)	
Background . . . . .	IV-3
Physical Characteristics . . . . .	IV-3
Features . . . . .	IV-4
Objectives . . . . .	IV-4
Achievements . . . . .	IV-7
DME-A Satellite . . . . .	IV-9
Background . . . . .	IV-11
Physical Characteristics . . . . .	IV-11
Features . . . . .	IV-11
Objectives . . . . .	IV-12
Achievements . . . . .	IV-12

CONTENTS (Concluded)

	Page
P76-5 Satellite . . . . .	IV-13
Background . . . . .	IV-15
Physical Characteristics . . . . .	IV-15
Features . . . . .	IV-15
Objectives . . . . .	IV-18
Achievements . . . . .	IV-18
 V. ASTRONOMICAL EXPLORATION SATELLITES	
 SAS-A and -B Satellites . . . . .	V-1
Background . . . . .	V-3
Physical Characteristics . . . . .	V-3
Features (Control Section) . . . . .	V-3
Objectives . . . . .	V-6
Achievements . . . . .	V-7
 SAS-C Satellite . . . . .	V-9
Background . . . . .	V-11
Physical Characteristics . . . . .	V-11
Features . . . . .	V-13
Objectives . . . . .	V-13
Achievements . . . . .	V-15
 APPENDIXES	
 A. Definitions and Abbreviations . . . . .	A-3
 B. The Navy Navigation Satellite System . . . . .	B-1
 C. Bibliography . . . . .	C-1



ILLUSTRATIONS

		Page
I-1	Satellite 1-A, Launch Configuration . . . . .	I-2
I-2	Satellite 1-A, Cutaway View . . . . .	I-4
I-3	Satellite 1-B, Artist's Concept . . . . .	I-8
I-4	Satellite 1-B, Cutaway View . . . . .	I-10
I-5	Satellite 2-A . . . . .	I-14
I-6	Satellite 2-A, Cutaway View . . . . .	I-16
I-7	Satellite 3-A . . . . .	I-20
I-8	Satellite 3-A, Cutaway View . . . . .	I-22
I-9	Satellite 3-B and LOFTI Pickaback Satellite . . . . .	I-24
I-10	Satellite 3-B, Cutaway View . . . . .	I-26
I-11	Satellite 4-A . . . . .	I-30
I-12	Satellite 4-A, Cutaway View . . . . .	I-33
I-13	Satellite 4-A and Pickaback Satellites . . . . .	I-35
I-14	Satellite 4-B . . . . .	I-36
I-15	Satellite 4-B, Cutaway View . . . . .	I-37
I-16	Satellite 5A-1, Artist's Concept . . . . .	I-40
I-17	Satellite 5A-2 on Vibration Test Table . . . . .	I-43
I-18	Satellite 5A (Typical), Orbit Configuration . . . . .	I-44
I-19	Satellite 5BN-1, Artist's Concept . . . . .	I-48
I-20	Satellite 5BN (Typical), Exploded View . . . . .	I-51
I-21	Satellite 5BN-2 Atop Satellite 5E-3 . . . . .	I-52
I-22	Satellite 5C-1, Artist's Concept . . . . .	I-56
I-23	Satellite 5C-1, Cutaway View . . . . .	I-58

ILLUSTRATIONS (Continued)

		Page
I-24	Satellite 5C-1 During Vibration Test . . . . .	I-59
I-25	Operational (Oscar) Navy Navigation Satellite, Artist's Concept . . . . .	I-62
I-26	Oscar 4 Satellite . . . . .	I-65
I-27	Interior View of Navy Navigation Satellite (Oscar 6) . . . . .	I-66
I-28	NNS (Oscar 15) Simplified Functional Block Diagram . . . . .	I-67
I-29	TRIAD Satellite, Artist's Concept . . . . .	I-72
I-30	TRIAD Satellite System Block Diagram . . . . .	I-74
I-31	DISCOS, Cutaway View . . . . .	I-76
I-32	TIP Satellite, Artist's Concept . . . . .	I-82
I-33	TIP Satellite System Block Diagram . . . . .	I-85
I-34	Single-Axis DISCOS . . . . .	I-87
I-35	TRANSAT Artist's Concept . . . . .	I-92
I-36	TRANSAT in SATRACK/Range Safety Test Configuration	I-95
I-37	TRANSAT Functional Block Diagram . . . . .	I-97
II-1	ANNA-1B Satellite, Artist's Concept . . . . .	II-2
II-2	ANNA-1A Satellite . . . . .	II-4
II-3	ANNA-1B Satellite, Cutaway View . . . . .	II-5
II-4	ANNA-1B Optical Beacon Test . . . . .	II-7
II-5	GEOS-A Satellite, Artist's Concept . . . . .	II-10
II-6	GEOS-B Satellite, Artist's Concept . . . . .	II-12
II-7	GEOS-B Satellite, Cutaway View . . . . .	II-13
II-8	LIDOS Satellite, Artist's Concept . . . . .	II-18

ILLUSTRATIONS (Continued)

		Page
II-9	LIDOS Launch Sequence . . . . .	II-22
II-10	GEOS-C Satellite, Artist's Concept . . . . .	II-24
II-11	GEOS-C Cutaway View . . . . .	II-26
II-12	GEOS-C Satellite Subsystems Block Diagram . . . . .	II-27
II-13	GEOS-C Calibration Configuration . . . . .	II-29
II-14	Satellite-to-Satellite Experiment Configuration . . . . .	II-29
III-1	TRAAC Satellite . . . . .	III-2
III-2	TRAAC Satellite, Cutaway View . . . . .	III-4
III-3	Satellite 5E-1, Artist's Concept . . . . .	III-8
III-4	Satellite 5E-3, Artist's Concept . . . . .	III-11
III-5	Satellite 5E-5, Artist's Concept . . . . .	III-12
III-6	Satellite 5E-1, Cutaway View . . . . .	III-13
III-7	Satellite 5E-2, Cutaway View . . . . .	III-14
III-8	Satellite 5E-5 . . . . .	III-17
III-9	DODGE Satellite, Artist's Concept . . . . .	III-24
III-10	DODGE Satellite During Sunlight Tests . . . . .	III-26
III-11	Earth as Photographed from DODGE Satellite on 23 September 1968 . . . . .	III-31
IV-1	BE-A Satellite, Artist's Concept . . . . .	IV-2
IV-2	BE-A Satellite, Cutaway View . . . . .	IV-5
IV-3	BE-A Satellite, Exploded View . . . . .	IV-6
IV-4	DME-A Satellite . . . . .	IV-10
IV-5	P76-5 Satellite, Artist's Concept . . . . .	IV-14

ILLUSTRATIONS (Concluded)

		Page
IV-6	P76-5 Spacecraft Orbital Configuration . . .	IV-16
IV-7	P76-5 Satellite Simplified Block Diagram . . .	IV-17
V-1	SAS-A Satellite, Artist's Concept . . . . .	V-2
V-2	SAS-A Liftoff from San Marco Equatorial Range . . . . .	V-4
V-3	SAS-B satellite, Artist's Concept . . . . .	V-5
V-4	SAS-C Satellite, Artist's Concept . . . . .	V-10
V-5	SAS-C Satellite Mounted on Spin Table . . . . .	V-12
V-6	SAS-C Control Section and Orbital Configuration . . . . .	V-14
B-1	Navy Navigation Satellite System . . . . .	B-2
B-2	Navy Navigation Satellites in Polar Orbit with 45° Nodes . . . . .	B-3
B-3	Integrated Doppler Measurement . . . . .	B-7
B-4	Doppler Frequency Variation with Time . . . . .	B-8
B-5	Organization of Satellite Message . . . . .	B-12
B-6	Detected Signal Characteristics . . . . .	B-13
B-7	Typical Two-Minute Message Printout . . . . .	B-15
B-8	Satellite Word Code Format . . . . .	B-16

TABLES

		Page
1	APL Designed and Fabricated Satellites, Designations and Nominal Orbit Data . . .	4
I-1	Oscar Satellite Orbits . . . . .	I-63
I-2	Oscar Satellite Features . . . . .	I-68
I-3	Oscar Satellite RMS Oscillator Stabilities . . . . .	I-69
I-4	TRIAD Satellite Features . . . . .	I-75
I-5	TIP Satellite Features . . . . .	I-86
C-1	Navy Navigation Satellite System Bibliography . . . . .	C-1
C-2	Publications Based on Satellite 5E Data . . . . .	C-8
C-3	DODGE Satellite Bibliography . . . . .	C-13

## INTRODUCTION

The Applied Physics Laboratory has been deeply involved in satellite technological development since 1958. APL satellite programs generally extend through conceptual development to implementation and operations, significant contributions and achievements being in areas in which the Laboratory is uniquely equipped.

One of the original assignments of the APL Space Department was to design and construct satellites as part of the APL-proposed Navy Navigation Satellite System. This included satellite signal receiver development, and the deployment of these receivers in a suitable worldwide system of tracking stations that were linked via a communication network to APL. In addition to advanced engineering research in satellite orbital dynamics, research was conducted to explore more fully the satellites' operational environment: the gravitational field, the effects of solar radiation and cosmic rays, the ionospheric and tropospheric refraction of radio waves, and geomagnetic phenomena. Efforts of the Department then turned to advanced navigation satellite systems development, and the design and fabrication of doppler beacon systems for Air Force satellites and satellite support systems for astronomical explorations.

More recent work includes design and development of: an Active Magnetospheric Particle Tracker Experiment (AMPTE) Satellite that will chart the flow of charged particles released from a spacecraft designed by the Max Planck Institute for Extraterrestrial Physics of West Germany; a Magnetic Survey Satellite (MAGSAT) for the NASA Applications Explorer Mission; a satellite-borne Navigational Package (NAVPAC) which automatically acquires and simultaneously tracks signals from as many as three Navy Navigation Satellites to provide very accurate satellite positioning data; and a Global Positioning System Package (GPSPAC) to provide real-time position fixes aboard a spacecraft using signals received from GPS satellites.

APL satellites have achieved a number of space highlights; some of these are discussed briefly in the following paragraphs.

- Navigation Satellite - The first successful launching of a Transit satellite (1B in 1960) validated satellite doppler navigation.

- Geodetic Satellite - The first satellite designed specifically for geodetic research (ANNA 1B) was launched in 1962.

- Electronic Memory - The Transit III-B satellite was the first to employ an electronic memory.
- Radioisotope Power - Transit 4A was the first satellite to carry a radioisotope power supply into space. Transit 5BN-1 was the first to use a radioisotope generator for all primary power.
- Electromagnetic Stabilization - The TRAAC satellite was the first to use electromagnets for temporary magnetic stabilization.
- Gravity Gradient Stabilization - Transit 5A-3 (in 1963) was the first satellite to achieve gravity gradient stabilization, and most APL satellites have been since stabilized using this technique. The DODGE satellite was three-axis gravity gradient stabilized at near-synchronous altitude. GEOS-3 (in 1975) demonstrated the first use of this technique to achieve satellite attitude stabilization to less than  $1^\circ$  in three axes.
- Operational Satellite Navigation System - Operational use of the Transit system by the US Navy began in July 1964. The first operational satellite navigation system, it has found increasing use by Naval ships of all types, merchant ships, surveyors, ocean research ships, and fishing boats.
- Satellite Ultraviolet Astronomy - The ultraviolet telescope aboard the 5E5 satellite made the first comprehensive ultraviolet stellar survey from orbit in 1965.
- First Full-Disc Photograph of the Earth - The DODGE TV camera made the first full-disc color photograph of the earth on 25 July 1967 using a three-color filter wheel system.
- Disturbance Compensation System - The TRIAD satellite was the first drag-free near-earth satellite and made possible long-term orbit prediction.
- Incremental Phase Shifter - TRIAD used the first satellite-borne system designed to compensate for long-term oscillator drift.
- Pseudorandom Noise System - The first system to provide a nonjammable modulation pattern on the satellite transmissions that, when recovered in suitable equipped receivers, enabled timing data of nonosecond accuracy for navigation by range measurement (TRIAD). It also made possible the first demonstration of single-frequency refraction free satellite navigation.

● Satellite-to-Satellite Tracking and Data Relay - The first satellite (GEOS-C) whose precise position was determined by another satellite (ATS-6). The GEOS-C/ATS-6/ground station link was used to determine the GEOS-C range and range rate for tracking and orbit determination and also provide GEOS-C altimeter data for increased global coverage.

Table 1 presents a chronological listing of APL satellites, together with the various satellite designations and orbital parameters. The longest operational life of any APL satellite is that of Transit 4A; in fact, this satellite has had the longest operating life of any satellite launched by the United States. It was launched on 29 June 1961 and is still transmitting.

The current names of launch sites are given. For example, the early satellites developed by APL for the US Navy (2-A, 3-A, etc.) were launched from Cape Canaveral (part of the Eastern Test Range) which is now designated Kennedy Space Center, Florida. Similarly, other satellites were launched from Point Arguello (part of the Western Test Range) which was located on, and later integrated with, Vandenberg Air Force Base, California. NASA's Wallops Station is now Wallops Flight Center, Wallops Island, Virginia.

The navigation satellites developed and fabricated by APL were for the US Navy. LIDOS, TRAAC, and the 5E-series of satellites were also Navy satellites. The ANNA satellites were under joint Army, Navy, and Air Force sponsorship. DME-A and the GEOS, Beacon Explorer, and SAS satellites were developed and fabricated by APL for NASA. The DODGE satellite was sponsored by DoD.

This publication describes satellites designed and fabricated by APL. Satellites for which APL did not have design responsibility (e.g., the doppler beacon series of satellites) are not included. The satellites are arranged in chronological order according to primary mission; note that most APL satellites have several design objectives and that, for example, the navigation satellites are also used for geodesy.

Satellite navigation equipment developed by the Space Department are described in "Navy Navigation Satellite System User Equipment Handbook", APL/JHU SDO 3100, and support and experimental systems are described in "Instrumentation Developed by JHU/APL for Non-APL Spacecraft", APL/JHU SDO-4100. The dissemination of revised and new material for this series of publications is made according to a distribution list maintained at the Applied Physics Laboratory, Space Department.



Table 1  
APL Designed and Fabricated Satellites, Designations and Nominal Orbit Data\*

Common Name(1)	Catalog Number	Satellite Designation		Launch Date	Offset and Frequency(2)	Inclination	Orbit Data(3)	Apogee/Perigee	Ceased Transmitting
		APL - International	NWL				Period		
1-A	00031	1960	72	9/17/59	(None) A, B	(Failed to Orbit)	94	780/ 382	7/11/60
1-B	00045	1960	71	4/13/60	(None) B, C	51.3	102	1078/ 826	10/26/62
2-A	00087	1961	71	11/30/60	(None) B, C	(Failed to Orbit)	95	966/ 180	3/30/61
3-A	00116	1961	01	2/21/61	-35 C, Z	28.4	103	1001/ 889	-
3-B	00202	1961	01	6/29/61	-78 C, Z	67.5	105	1121/ 956	8/2/62
4-A	00205	1961	01	11/15/61	-37 C	32.4	105	1121/ 956	8/12/62
TRAAC	00446	1962	01	5/10/62	-77 B, C	(Failed to Orbit)	108	1190/1084	-
ANNA-1A	00609	1962	01	10/31/62	-80 Z	50.1	97	738/ 700	12/19/62
ANNA-1B	00584	1963	22A	4/5/63	-80 Z	(Failed to Orbit)	101	775/ 726	-
5A-2	00670	1963	36B	6/16/63	-80 Z	90.0	107	1128/1078	12/22/63
5A3	00704	1963	48B	9/28/63	-80 C	89.9	107	1128/1078	-
5B-1	00705	1963	49C	12/ 5/63	-80 C, Y	90.0	107	1108/1078	-
5E1	00801	1964	26A	12/ 5/63	-80 Z	(Failed to Orbit)	103	958/ 850	8/23/65
5E2	00899	1964	64A	3/19/64	-80 Y	(Failed to Orbit)	105	1086/ 891	-
5E3	00959	1964	83C	4/21/64	-80 Y	(Failed to Orbit)	104	1078/1034	-
BE-A	01328	1965	32A	6/ 4/64	-80 Z	90.6	108	1356/ 938	-
5B-3	01420	1965	48C	10/ 9/64	-80 Z	79.7	120	2275/1117	1/28/66
5E-2	01726	1965	89A	12/13/64	-80 Y	90.0	121	2957/ 497	2/18/68
5C1	02185	1965	89A	4/29/65	-80 Z	90.0	104	1078/1034	-
BE-B	02185	1965	89A	6/24/65	-80 Z	90.0	107	1329/1027	-
5E-5	02185	1965	89A	11/ 6/65	-50 Y, T	59.4	120	2275/1117	-
BEC	02185	1965	89A	11/29/65	-	79.8	121	2957/ 497	-
O-4	01864	1965	109A	12/22/65	-80 Z	89.1	105	904/ 902	8/ 5/66
GEOS-A	02119	1966	24A	3/25/66	-80 Z	89.7	105	1123/ 883	2/25/67
DME-A	02176	1966	41A	5/19/66	-80 Z	89.8	104	975/ 865	3/ 1/67
O-6	02401	1966	76A	8/18/66	-80 Z	88.9	107	1112/1045	-
O-8	02754	1967	34A	4/14/67	-80 Z	90.2	106	1088/1040	-
O-9									
O-10									
O-12									

\*Footnotes

- Abbreviations: TRACC = Transit Research and Attitude Control; ANNA = Army, Navy, NASA, Air Force; BE A, B, & C = Beacon Explorer A, B, & C; O = Oscar (Operational Navy Navigation Satellite, formerly Transit); GEOS = Geodetic Earth Orbiting Satellite; DME = Direct Measurement Explorer.
- Doppler frequencies only; legend: A = 54/108 MHz, B = 162/216 MHz, C = 54/324 MHz, T = 324/972 MHz, Y = 162/324 MHz, Z = 150/400 MHz; Offset in ppm.
- Inclination in degrees from equator; Period in minutes; Apogee/Perigee in kilometers (approx.)

Table 1 (Concluded)  
 APL Designed and Fabricated Satellites, Designations and Nominal Orbit Data\*

Common Name <sup>(1)</sup>	Catalog Number	APL - International - NWL	Satellite Designation	Launch Date	Offset and Frequencies <sup>(2)</sup>	Inclination	Orbit Data <sup>(3)</sup> Period	Apogee/Perigee	Ceased Transmitting
O-13	02807	30130	1967 48A	5/16/67	-80 Z	89.6	107	1104/ 1067	-
DODGE	02867	01167	1967 66F	7/ 1/67	-20 (240 MHz)	5.2	1319	33650/33243	-
O-14	02985	30140	1967 92A	9/25/67	-80 Z	89.2	107	1114/ 1040	-
GEOS-B	03093	01168	1968 02A	1/11/68	-50 Y, T	105.8	112	1581/ 1078	-
LIDOS				8/16/68		(Failed to Orbit)			
SAS-A	04797	-	1970 107A	12/12/70	-	03	94.8	532/502	4/11/73
TRIAD	06173	01172	1972 69A	9/ 2/72	-84/-145 Z	90.1	101	810/728	-
SAS-B	06282	-	1972 91A	11/15/72	-	01.9	95	608/439	-
GEOS-C	07734	01175	1975 27A	4/9/75	-	114.9	101.7	849/838	-
SAS-C	07788	-	1975 37A	5/7/75	-	2.99	94.9	517/510	-
TIP II	08361	30460	1975 99A	10/12/75	-80/-145 Z	90.38	98.8	830/ 580	-
P76-5	08880	30900	1976 47A	5/22/76	-141.5 Z	99.67	105.6	1064/ 980	-
TIP III	09403	30470	1976 89A	9/ 1/76	-80/-145 Z	89.29	97.9	867/ 452	-
O-11/ TRANSAT	10457	30110	1977 106A	10/28/77	-80 Z/-140	89.92	107	1108/1069	-

\*Footnotes

- Abbreviations: O - Oscar (Operational Navy Navigation Satellite, formerly Transit); DODGE - Department of Defense Gravity Experiment; GEOS - Geodetic Earth Orbiting Satellite; LIDOS - Low Inclination Doppler Only Satellite; SAS - Small Astronomy Satellite; GEOS-C - Geodynamics Experimental Ocean Satellite; TIP - Transit Improvement Program; TRANSAT - Translator Satellite.
- Doppler frequencies only; legend: A = 54/108 MHz, B = 162/216 MHz, C = 54/324 MHz, T = 324/972 MHz, Y = 162/324 MHz, Z = 150/400 MHz; Offset in ppm.
- Inclination in degrees from equator; Period in minutes, Apogee/Perigee in kilometers (approx.)

### HISTORICAL NOTE

The Laboratory's involvement in space started on a modest note shortly after the USSR announced the successful launch of Sputnik I. At that time two staff scientists, W. H. Guier and G. C. Weiffenbach, improvised a satellite tracking station consisting of a radio receiver and tape recorder. The signal from the Russian satellite exhibited the predicted doppler frequency shift; there was a pronounced change in the frequency of Sputnik's "beep" as it passed over the station. In order to facilitate identification of the signal, which was in an overcrowded region of the RF spectrum, the received frequencies were carefully examined and their variation, i.e., the doppler shift, calculated.

Encouraged by the agreement between satellite tracking results and estimates derived from the precalculated doppler shift, Drs. Guier and Weiffenbach arduously computed the satellite's orbital parameters with pencil and slide rule. They soon put a harmonic analyzer and analog recorder to work and, by January 1958, were satisfied that they had established with considerable accuracy the parameters of the satellite's orbit by means of the doppler principle.

Dr. F. T. McClure, then Chairman of the Research Center and later Associate Director of the Laboratory, noted the results achieved by Guier and Weiffenbach and suggested the application of these results to the converse problem: knowing the orbit parameters of a satellite accurately, and observing the doppler shift of a signal from the satellite, derive the position of the observer.\* His recommendation to Dr. R. F. Gibson, then Director and now Director Emeritus of the Laboratory, that the development of a satellite navigation system based on the doppler principle be strongly pursued led to the formation of the APL Space Development Division (changed to a Department in 1966) and the appointment of Dr. R. B. Kershner, now also Assistant Director, as its head. With the approval of the Advanced Research Projects Agency, the US Navy adopted the scheme and APL set about building its first satellite.

---

\* In recognition of his contribution to satellite navigation, Dr. McClure was presented with the Invention Award of the National Aeronautics and Space Administration on 17 January 1961.

This satellite, appropriately labeled Transit 1A, was launched from Cape Canaveral (later renamed John F. Kennedy Space Center), Florida, on 17 September 1959. The 270-pound satellite flew only a suborbital trajectory because the third stage of its Thor-Able launch vehicle failed to ignite; however, all satellite systems operated as planned during the 24-minute flight and sufficient data were gathered to demonstrate the practicality of the satellite doppler tracking technique.

THE JOHNS HOPKINS UNIVERSITY  
APPLIED PHYSICS LABORATORY  
LAUREL, MARYLAND

SDO 1600  
May 1975

SATELLITE 1-A

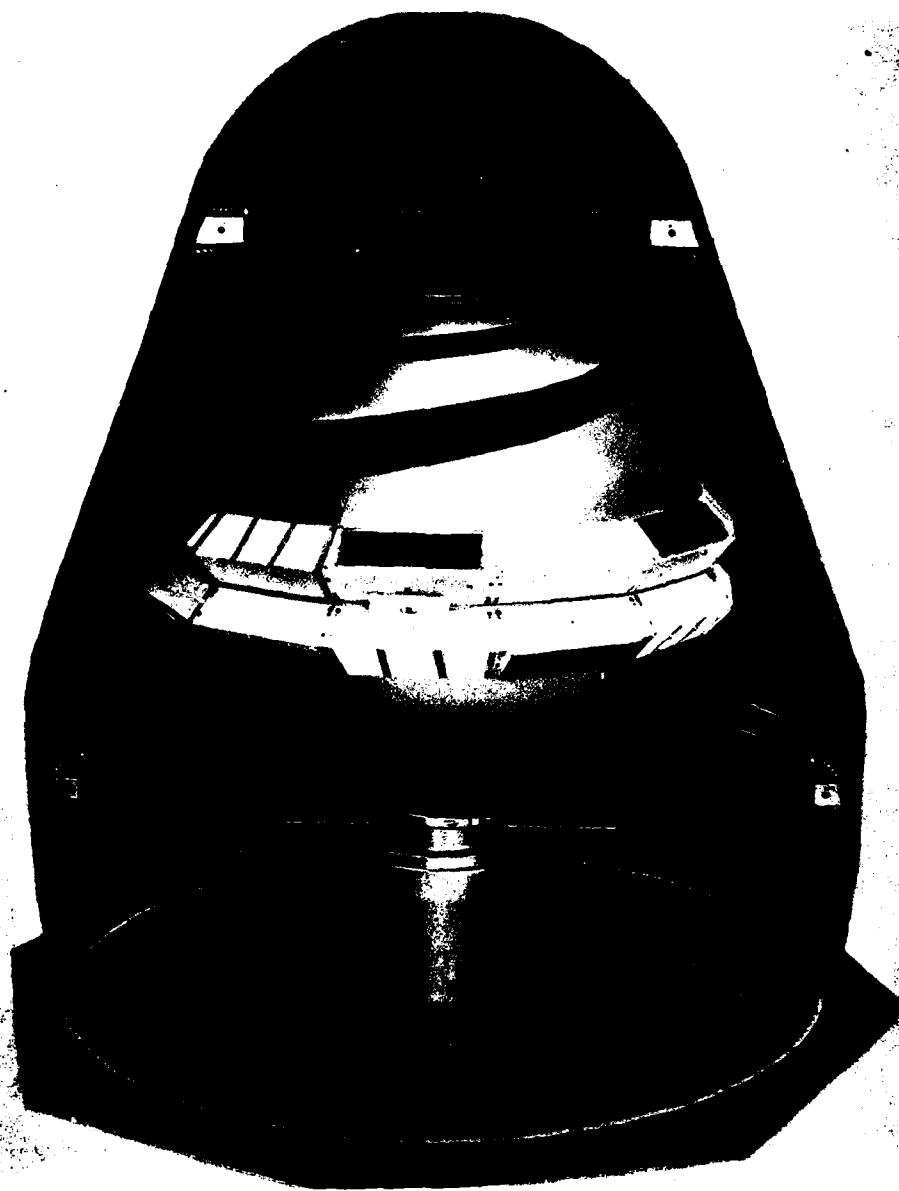

Fig. I-1 Satellite 1-A, Launch Configuration

SATELLITE 1-A

Launch: 17 September 1959; Kennedy Space Center, Florida  
Vehicle: Thor-Able (three stage)  
Orbit: Not achieved  
Remarks: Vehicle third stage failed to ignite and payload burned on reentry several hundred miles west of Ireland.

Background

The first five satellites designed and fabricated by APL (Satellite 1A and Satellites 1B, 2A, 3A, and 3B following) were intended primarily for navigation and had essentially the same external configuration - a sphere with a belt about the equator on which were mounted solar cells. The antennas were painted onto the body of the satellite in logarithmic spirals. Later, a similar configuration was used for the ANNA 1A and 1B geodetic satellites.

Physical Characteristics (Fig. I-1)

Body: Sphere, 91.44 cm (36 in.) dia  
Solar Cells: Equatorial band  
Weight: 121.50 kg (270 lb).

Features (Fig. I-2)

Two stable oscillators  
Transmitters: 54/108 MHz, 162/216 MHz, and 108 MHz (TM).  
Power: Ag-Zn batteries (System 1) and solar cells/Ni-Cd batteries (System 2)  
Solar cell performance experiment  
Yo-yo despin system  
Mechanical clock  
Infrared scanner (supplied by NOTS)  
Command System: Four operating modes  
Telemetry: Seven data channels (PDM) and one calibration channel amplitude modulating the 108 MHz and 162 MHz carriers

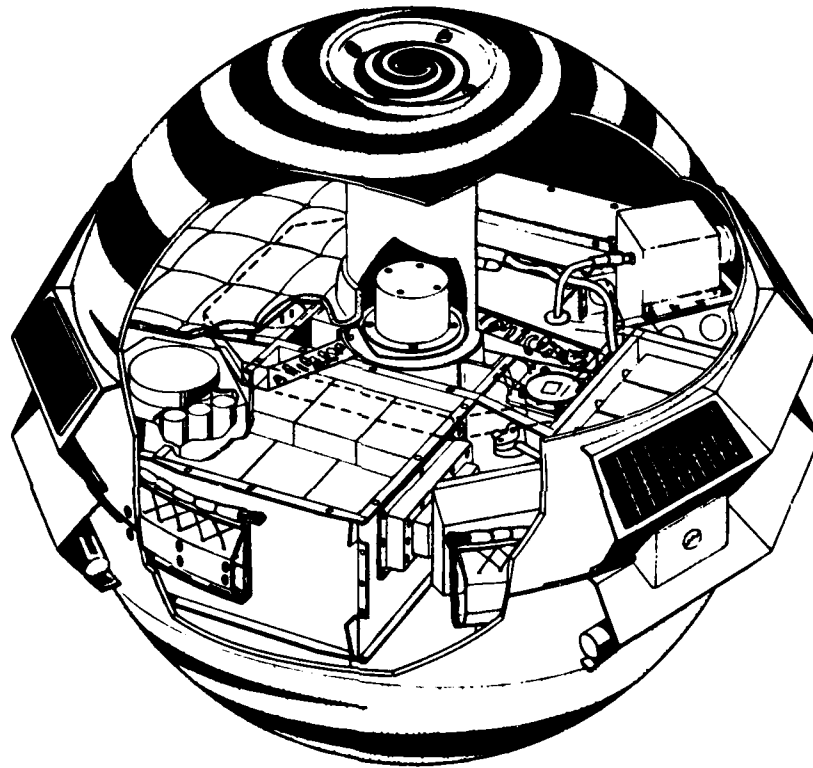

Fig. 1-2 Satellite 1-A, Cutaway View



Logarithmic spiral antenna system silver-painted on hemisphere.

### Objectives

1. Demonstrate satisfactory operation of the payload, tracking stations, and data processing systems.
2. Demonstrate the satellite radio doppler tracking technique.
3. Determine the adequacy of multiple frequency (coherent) measurements in the elimination of ionospheric refraction effects.
4. Improve knowledge of the shape of the earth and its force field.
5. Make infrared measurements from orbit.

### Achievements

Although data were acquired only during a partial pass of the satellite, Objectives 1, 2, and 3 were partially satisfied. The vehicle reached the planned altitude of 400 nmi and data were received on all frequencies from the moment of lift-off to destruction. A portable station at the US Naval Air Station in Argentia, Newfoundland, also recorded doppler data. The flight lasted 24 minutes.

An ionospheric refraction value was calculated using the doppler data recovered by the portable station, and a correction factor was then applied to the data to produce a doppler curve unaffected by ionospheric refraction. The Satellite 1-A trajectory thus determined was in close agreement with range track data.

THE JOHNS HOPKINS UNIVERSITY  
APPLIED PHYSICS LABORATORY  
LAUREL MARYLAND

SDO 1600  
May 1975

SATELLITE 1-B  
(1960 Y2)

I-7

FINISHING PAGE BLANK-NOT FILMED



Fig. 1-3 Satellite 1-B, Artist's Concept

SATELLITE 1-B

Launch: 13 April 1960; Kennedy Space Center, Florida  
Vehicle: Thor-Able-Star (two stage)  
Orbit: Apogee 759.7 km (410 nmi), perigee 381.7 km  
(206 nmi), inclination 51.3°  
Remarks: A prototype pickaback uninstrumented satellite was separated successfully by Satellite 1-B and subsequently designated 1960 Y 3.

Physical Characteristics (Fig. I-3)

Body: Sphere, 91.44 cm (36 in.) dia  
Solar Cells: Equatorial band  
Weight: 119.25 kg (265 lb).

Features (Fig. I-4)

Two stable oscillators (5 parts in  $10^9$  and 5 parts in  $10^{10}$ )  
Transmitters: 162/216 MHz and 54/324 MHz  
Magnetic orientation  
Power: Solar cells/Ni-Cd batteries (System 1) and Ag-Zn batteries (System 2)  
Yo-yo despin system  
Mechanical clock  
Infrared scanner (supplied by NOTS)  
Command System: Four operating modes  
Telemetry: Seven data channels (PDM) and one calibration channel amplitude modulating the 162 MHz carrier  
Pickaback satellite test  
Logarithmic spiral antenna system silver-painted on hemisphere.

Objectives

1. Demonstrate satisfactory operation of the payload, tracking stations, and data processing systems.

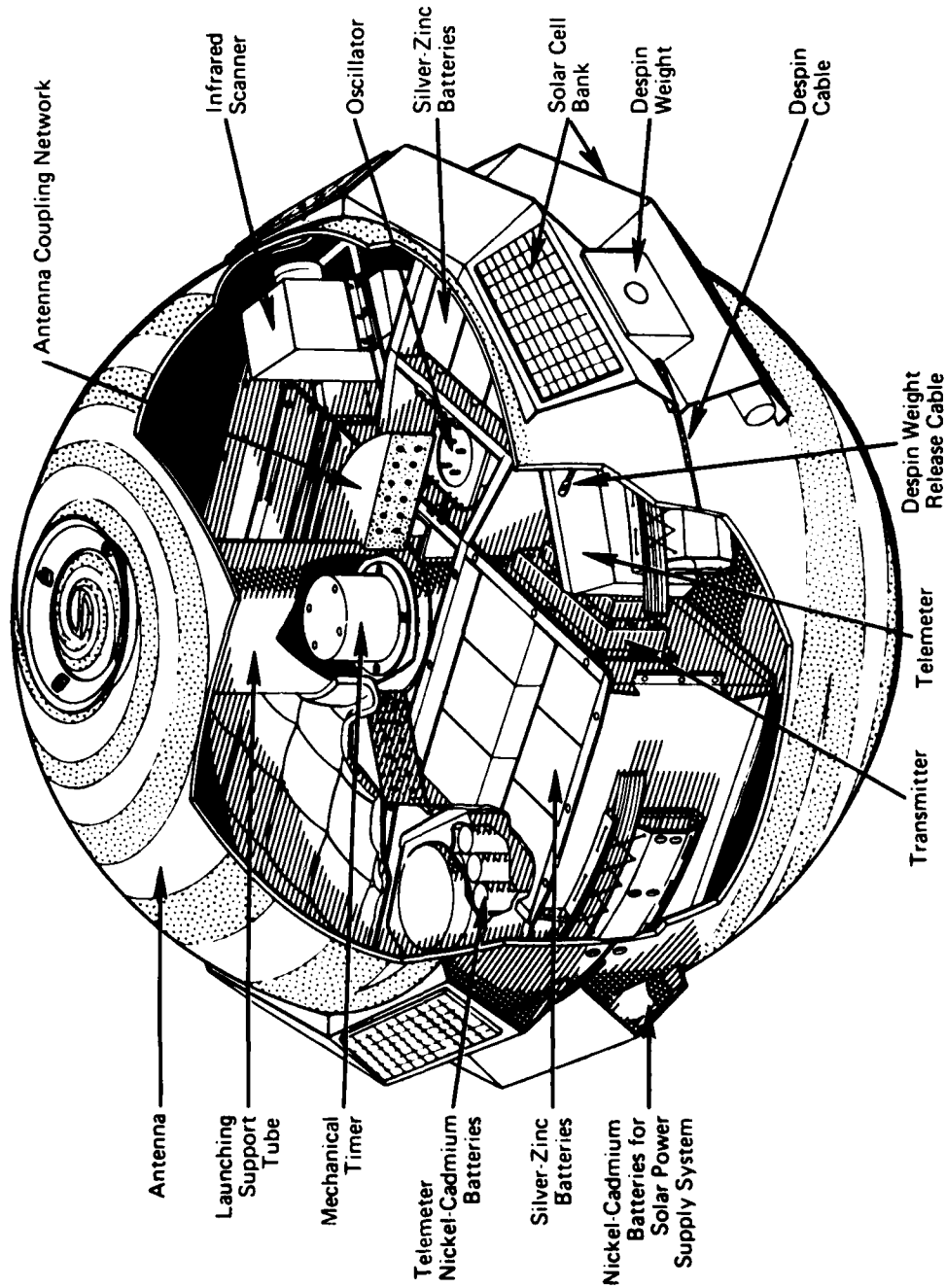

Fig. 1-4 Satellite 1-B, Cutaway View

2. Demonstrate the satellite radio doppler tracking technique.
3. Determine the adequacy of multiple frequency (coherent) measurements in the elimination of ionospheric refraction effects.
4. Improve knowledge of the shape of the earth and its force field.
5. Demonstrate feasibility of pickaback separation initiated by primary payload separation.
6. Demonstrate feasibility of removing satellite spin by the principles of magnetic hysteresis.
7. Demonstrate passive magnetic attitude control.
8. Make infrared measurements from orbit.

#### Achievements

All launch objectives were met.

Orbital data obtained from this satellite confirmed the asymmetry of the gravitational field of the earth relative to its equatorial plane (pear shape).

Satellite 1-B was the first to demonstrate the technique for separating a pickaback satellite in orbit and the first to utilize magnetic techniques as a means of attitude orientation.

The relative positions of several receiving stations were determined with high accuracy by the new satellite radio doppler technique.

As planned, the satellite spin rate was abruptly reduced on the seventh day after launch by yo-yo despin. Residual spin was removed by a passive magnetic hysteresis damping mechanism.

Satellite 1-B, which had an operating life of 89 days, stopped transmitting on 11 July 1960 as a result of the following:

1. A change in the calibration of a charge limiting thermostatic switch caused the switch to stop the solar charging current from reaching the batteries even though the battery temperatures indicated charge was required.

2. Not knowing that the above condition existed, a command was transmitted which placed an additional load on the battery. This added load drove the voltage so low in the following revolution that further switching was futile. On the next pass this problem was recognized, but commands that were transmitted in an effort to resolve the problem were not effective.

THE JOHNS HOPKINS UNIVERSITY  
APPLIED PHYSICS LABORATORY  
LAUREL, MARYLAND

SDO 1600  
May 1975

SATELLITE 2-A  
(1960 η1)





Fig. I-5 Satellite 2-A

SATELLITE 2-A

Launch: 22 June 1960; Kennedy Space Center, Florida  
Vehicle: Thor-Able-Star (two stage)  
Orbit: Apogee 1078.4 km (582 nmi), perigee 626.3 km  
(338 nmi), inclination 66.7°  
Remarks: SOL RAD I (GREB I), an NRL satellite, was launched  
pickaback and separated successfully.

Physical Characteristics (Fig. I-5)

Body: Sphere, 91.44 cm (36 in.) dia  
Solar Cells: Equatorial band  
Weight: 100.35 kg (223 lb).

Features (Fig. I-6)

Two stable oscillators (1 part in  $10^9$  and 7 parts in  $10^{10}$ )  
Transmitters: 162/216 MHz, 54/324 MHz, 108 MHz (TM), and  
NOTS infrared scanner on 107.9 MHz  
Magnetic orientation  
Power: Solar cells/Ni-Cd batteries  
Yo-yo despin system  
Mechanical and digital clocks  
Command System: Four operating modes  
Telemetry: FM/PM - three channel FM system plus seven data  
and one calibration channel PDM system  
Cosmic noise receiver and antenna (supplied by DRTE)  
Logarithmic spiral antenna system silver-painted on hemisphere.

Objectives

1. Determine in elementary form a basis for navigation trials and demonstrations.
2. Improve the understanding of the effects of ionospheric refraction on radio waves at higher latitudes.

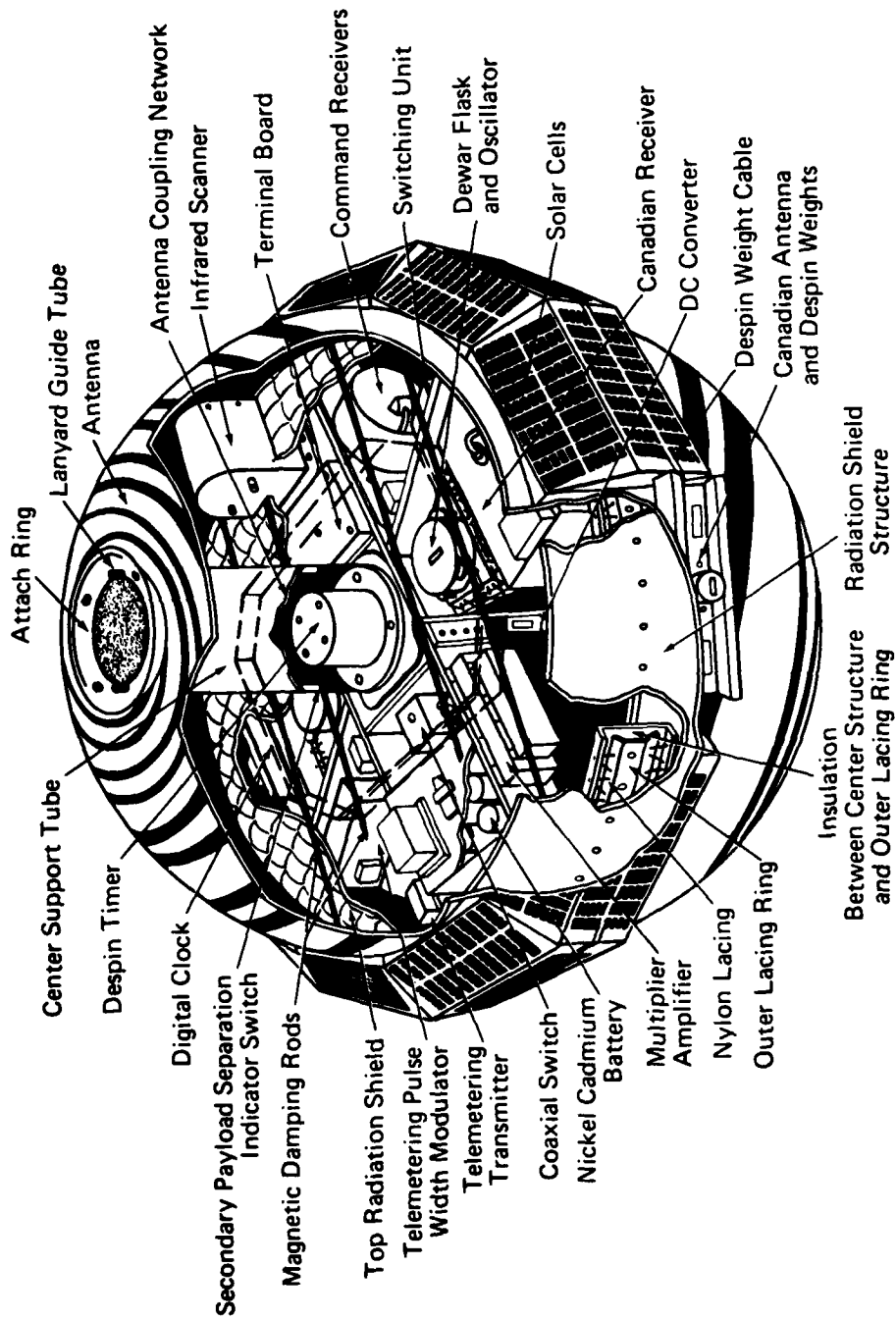

Fig. 1-6 Satellite 2-A, Cutaway View

3. Increase the accuracy of such geodetic measurements as the earth's gravitational field and the distance between land masses.
4. Improve satellite orbital tracking methods.
5. Study further the magnetic hysteresis despin technique.
6. Make infrared measurements from orbit.
7. Detect cosmic noise.

### Achievements

All Satellite 2-A launch objectives were met. This satellite not only confirmed the practicality of precise geodetic surveys using satellites, but provided critical measurements on the effect of the ionosphere on electromagnetic propagation (signals coherent), as well as a means of studying long term drag effects on artificial earth satellites.

A cosmic noise receiver was orbited aboard 2-A to assist DRTE/Canada in their preparation for the Alouette satellite program. The receiver was tuned to detect cosmic noise at a frequency of 3.8 MHz and was intentionally operated for only the first week in orbit.

Satellite 2-A was the first satellite to carry an independent auxiliary pickaback satellite into orbit and release it, and the first to carry the experiment of a foreign country.

An initial spin rate of 60 rpm was to be retained for the first week in orbit. Yo-yo despin system wires served as antennas for the cosmic noise receiver during this period. Subsequent to deactivating the DRTE receiver, the plan was for despin weights to fly out attached to these wires in typical yo-yo despin fashion, thus reducing spin abruptly. Any residual spin would then be removed by means of the magnetic hysteresis despin rods. These rods proved so effective that the satellite spin was markedly reduced by the end of the first week in orbit. The centrifugal force due to the despin weights was below the anticipated value and was in fact not sufficient to break the fine wires attached to these weights and hence the yo-yo system could not be released. Magnetic hysteresis eventually removed all satellite spin.

The infrared scanner accurately measured satellite spin rate in the process of locating infrared sources.

Satellite 2-A contained the same type of thermostatic switch that malfunctioned in Satellite 1-B (2-A was launched two weeks prior to the 1-B failure). To avoid a repetition of the 1-B failure, 2-A was commanded to the thermostat bypass mode prior to predicted thermostat failure time. Unfortunately, this mode also imposed the complete electrical load (both systems) on the batteries. Total load was approximately 10% greater than solar charge capacity and battery depletion eventually resulted. The satellite operated for 916 days.

THE JOHNS HOPKINS UNIVERSITY  
APPLIED PHYSICS LABORATORY  
LAUREL MARYLAND

SDO 1600  
May 1975

SATELLITE 3-A

I-19

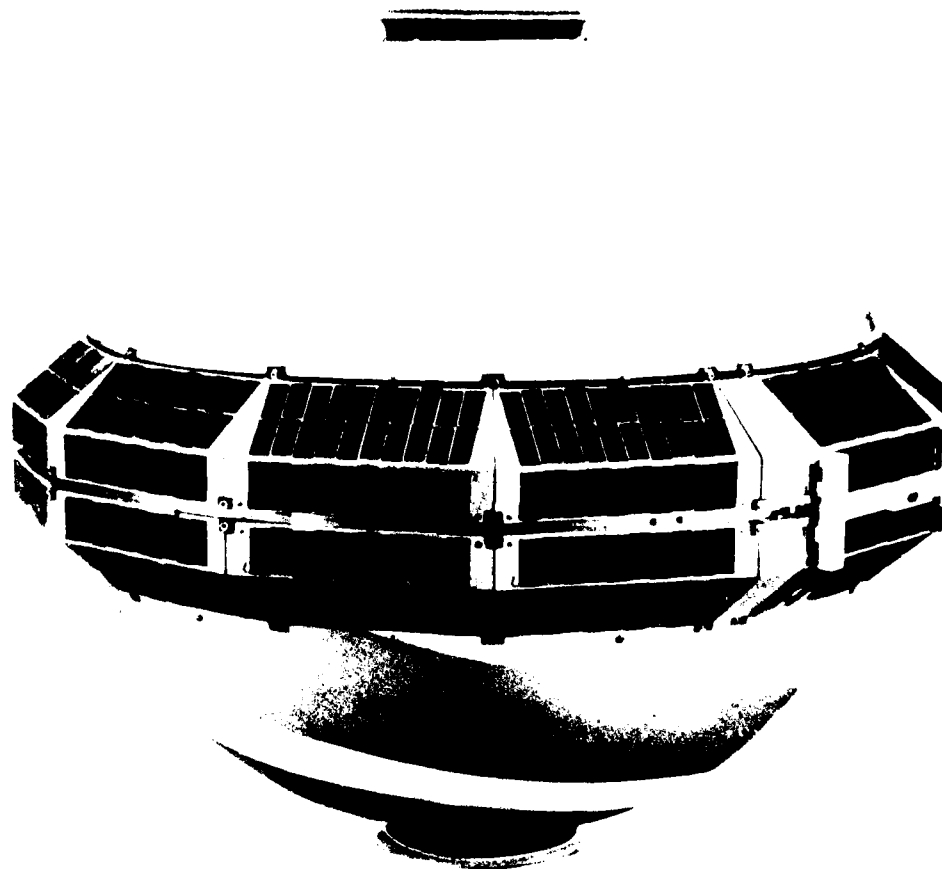

Fig. I-7 Satellite 3-A

SATELLITE 3-A

Launch: 30 November 1960; Kennedy Space Center, Florida  
Vehicle: Thor-Able-Star (two stage)  
Orbit: Not achieved  
Remarks: Boost vehicle malfunctioned and was destroyed.  
SOL RAD II (GREB II), an NRL satellite, was  
launched pickaback and was also lost.

Physical Characteristics (Fig. I-7)

Body: Sphere, 91.44 cm (36 in.) dia  
Solar Cells: Equatorial band  
Weight: 91.35 kg (203 lb).

Features (Fig. I-8)

Two stable oscillators  
Transmitters: 162/216 MHz, 54/324 MHz, and 108 MHz (TM)  
Magnetic orientation  
Power: Solar cells/Ni-Cd batteries  
Yo-yo despin system  
Mechanical and digital clocks  
Command System: Four operating modes  
Telemetry: PDM eight-channel system plus three channel  
FM/PM system  
Logarithmic spiral antenna system silver-painted on hemisphere.

Objectives

1. Provide a basis for navigation trials and demonstrations in an elementary form.
2. Improve the understanding of the effects of ionospheric refraction on radio waves at higher latitudes.
3. Increase the accuracy of such geodetic measurements as the earth's gravitational field and the distance between land masses.
4. Improve satellite tracking methods.



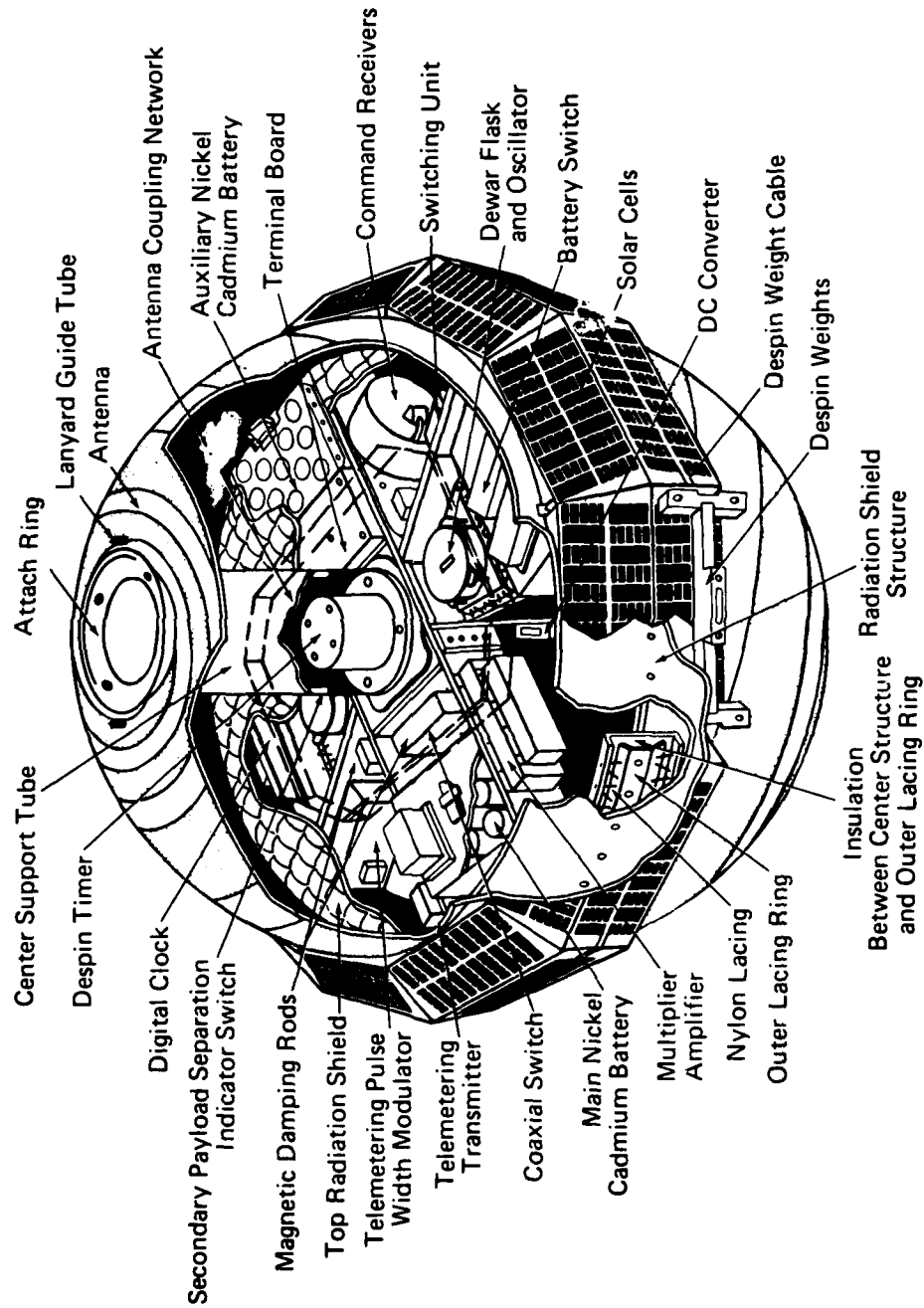

Fig. 1-8 Satellite 3-A, Cutaway View

THE JOHNS HOPKINS UNIVERSITY  
APPLIED PHYSICS LABORATORY  
LAUREL, MARYLAND

SDO 1600  
May 1975

SATELLITE 3-B  
(1961 η1)

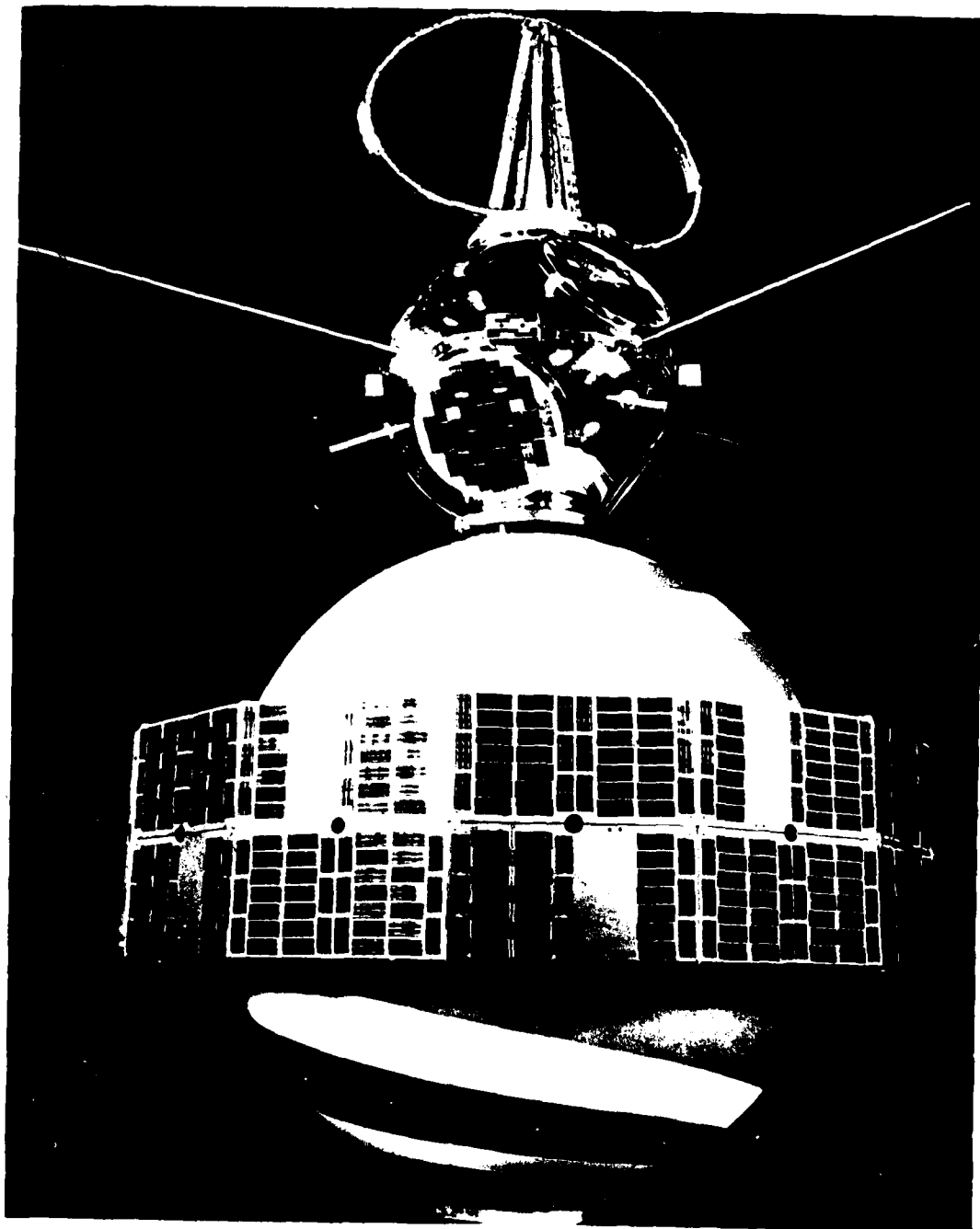

Fig. I-9 Satellite 3-B and LOFTI Pickaback Satellite

SATELLITE 3-B

Launch: 21 February 1961; Kennedy Space Center, Florida  
Vehicle: Thor-Able-Star (two stage)  
Orbit: Apogee 985.7 km (532 nmi), perigee 179.7 km  
(97 nmi), inclination 28.4°  
Remarks: Boost vehicle programmer malfunction resulted in  
no vehicle restart (injection) or payload separation  
signal. As a result, the NRL pickaback satellite  
LOFTI did not separate.

Physical Characteristics (Fig. I-9)

Body: Sphere, 91.44 cm (36 in.) dia  
Solar Cells: Equatorial band  
Weight: 170.64 kg (290.3 lb).

Features (Fig. I-10)

Two stable oscillators (both 5 parts in  $10^{10}$ )  
Transmitters: 162/216 MHz, 54/324 MHz, 136 MHz (TM), and  
224/421/448 MHz (SECOR)  
Magnetic orientation  
Power: Solar cells/Ni-Cd batteries  
Yo-yo despin system  
384-bit magnetic core shift register memory and digital  
clock  
Command System: Eight operating modes (two redundant  
receivers)  
Telemetry: PDM eight channel plus three commutated FM/PM  
channels  
SECOR equipped  
Logarithmic spiral antenna system silver-painted on  
hemisphere.

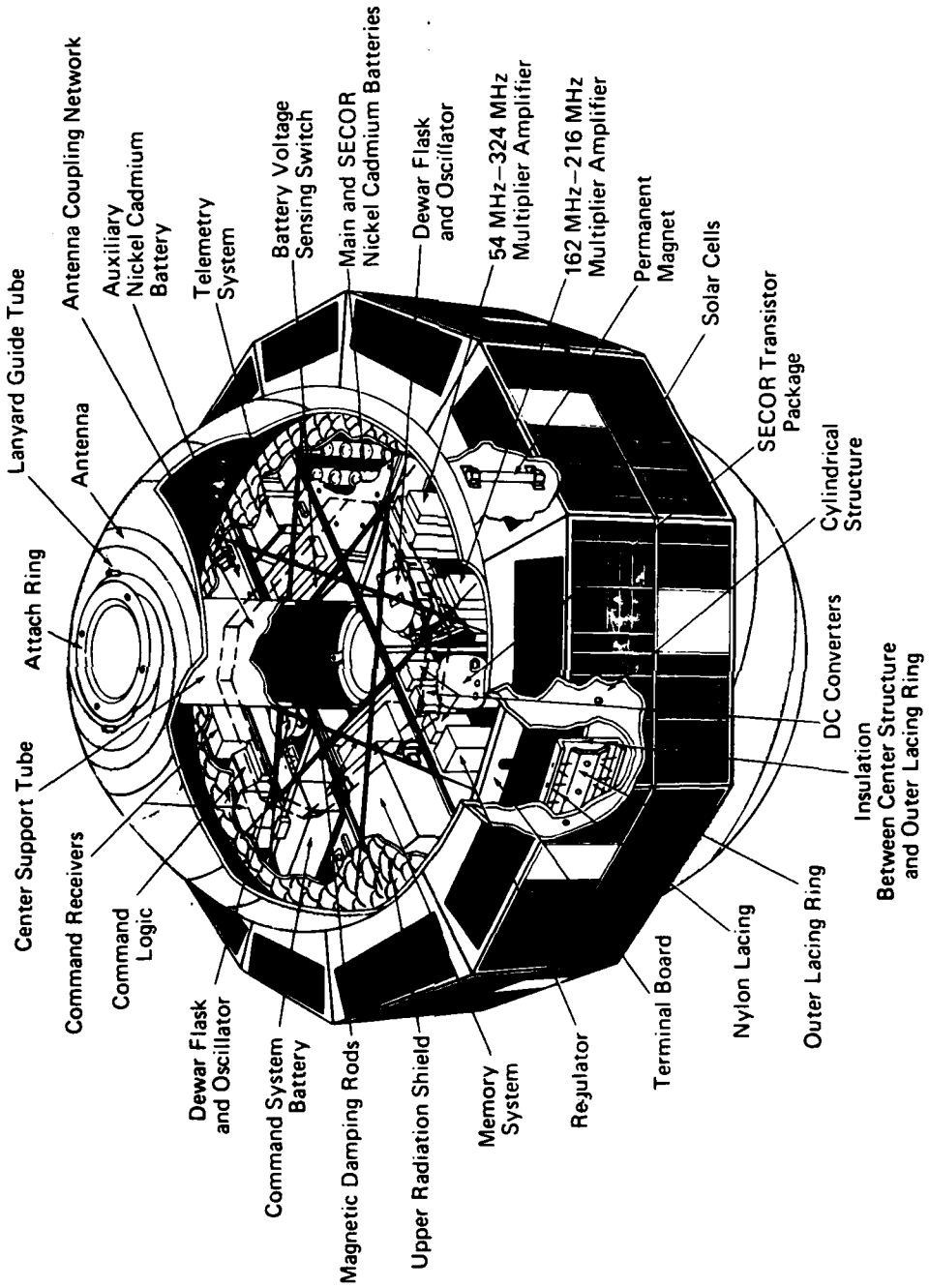

Fig. I-10 Satellite 3-B, Cutaway View

### Objectives

1. Provide a basis for navigation trials and demonstrations in elementary form. Demonstrate time recovery using a satellite digital clock and prototype memory operation.
2. Improve understanding of the effects of ionospheric refraction on radio waves. Because Satellite 3-B would be in a low-inclination orbit and transmit four coherent frequencies (derived from same oscillator), it could be used to investigate anomalies in the propagation of these frequencies. The ionosphere over the geomagnetic equator exhibits some anomalous properties such as very high electron densities and strong variations in electron density with longitude and elevation.
3. Increase knowledge of the earth's shape and gravitational field.

### Achievements

The major portion of Objective 1 was achieved but a poor orbit (perigee too low) would not permit achievement of Objectives 2 and 3.

Because the boost vehicle programmer did not restart the engine for proper orbital injection, or provide the signal to separate the payloads, the satellites remained attached to the vehicle and the orbit was low and elliptical. The satellites reentered the atmosphere and burned on 1 April 1961, 39 days after launch. As a result of drag due to the low perigee, 3-B could not be used for navigation and geodetic experiments. However, its electronics functioned perfectly and two major features of the satellite radio doppler navigation experiment were confirmed as follows:

1. A method of time synchronization using the digital clock and phase modulated signals was demonstrated.
2. Prototype navigation messages were successfully injected into the satellite memory and recovered unchanged as phase modulation on the satellite 162 and 324 MHz signals.

SATELLITES 4-A and 4-B

4-A  
(1961 01)

4-B  
(1961 01)

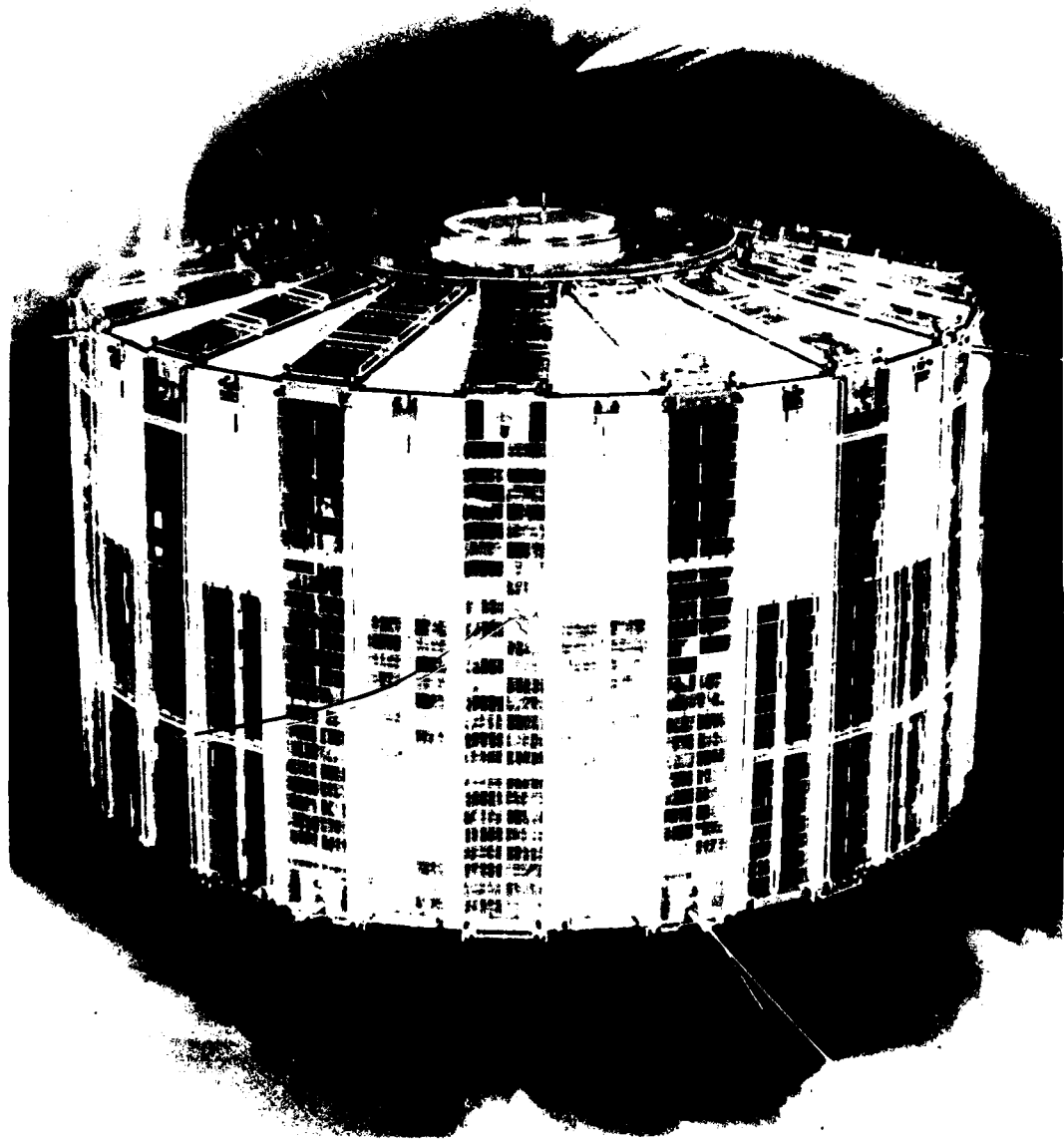

Fig. I-11 Satellite 4-A



SATELLITES 4-A AND 4-B

Launch: (4-A) 29 June 1961; Kennedy Space Center, Florida  
(4-B) 15 November 1961; Cape Kennedy, Florida

Vehicle: Thor-Able-Star (two stage)

Orbit: (4-A) Apogee 994 km (540 nmi), perigee 883 km  
(480 nmi), inclination 67.5°  
(4-B) Apogee 1,111 km (605 nmi), perigee 950 km  
(516 nmi), inclination 32.4°

Remarks: (4-A) The first satellite to carry two other  
satellites into orbit and separate from them;  
however, the other two satellites (INJUN provided  
by the State University of Iowa and the NRL satellite  
GREB III) did not separate from each other.

(4-B) This satellite was launched with pickaback  
TRAAC satellite; injection separation and  
interpayload separation were normal.

Background

The Satellite 4-A and 4-B design represented the first departure from the sphere-shaped configuration of the earlier satellites; it resembled a modified drum and had an expandable outer shell covered with solar cells. Satellite 4-A was the first space vehicle to employ a radioisotope power supply (RIPS) and the first to switch power systems by command; 4-B was similarly configured.

Physical Characteristics (Fig. I-11)

Body: Drum shape, 109.22 cm (43 in.) dia by 78.74 cm  
(31 in. high)

Solar Cells: Mounted on body

Weight: (4-A) 78.75 kg (175 lb)  
(4-B) 89.46 kg (198.8 lb).

### Features (Fig. I-12)

- (4-A) RMS oscillator stability: 2 parts in  $10^{10}$
- (4-B) Two oscillators (1 part in  $10^{10}$  and 3 parts in  $10^{10}$ ); the second oscillator was the first oven-controlled oscillator to be orbited

Transmitters: 54/324 MHz, 150/400 MHz, and 136 MHz (TM)

Magnetic orientation

Power: Solar cells/Ni-Cd batteries and RIPS (4-A, 2.6 watts; 4-B, 3.1 watts)

Magnetic hysteresis despin

- (4-A) 2049-bit magnetostriction delay line memory and digital clock
- (4-B) 1344-bit coincident current magnetic core memory and digital clock

Command System: (4-A) Eight operating modes; (4-B) 32 operating modes

Telemetry: (4-A) Six FM data channels on 3 subcarriers and 14 PDM data channels on 1 subcarrier all commutated on 136 MHz carrier; (4-B) three FM data channels plus 14 PDM data channels commutated on 136.8 MHz carrier

Whip and turnstile antenna system.

### Objectives

1. Conduct navigation trials and demonstrations.
2. Improve the understanding of the effects of ionospheric refraction on radio waves.
3. Increase knowledge of the earth's shape and gravitational field.

### Achievements

#### *Satellite 4-A:*

Met all launch objectives. Doppler data from this satellite confirmed that the equator of the earth is elliptical, not circular (long and short axes differ by approximately 250 feet). Satellite 2-A had measured a pear-shaped earth (north-south); 4-A measured an elliptical equator.

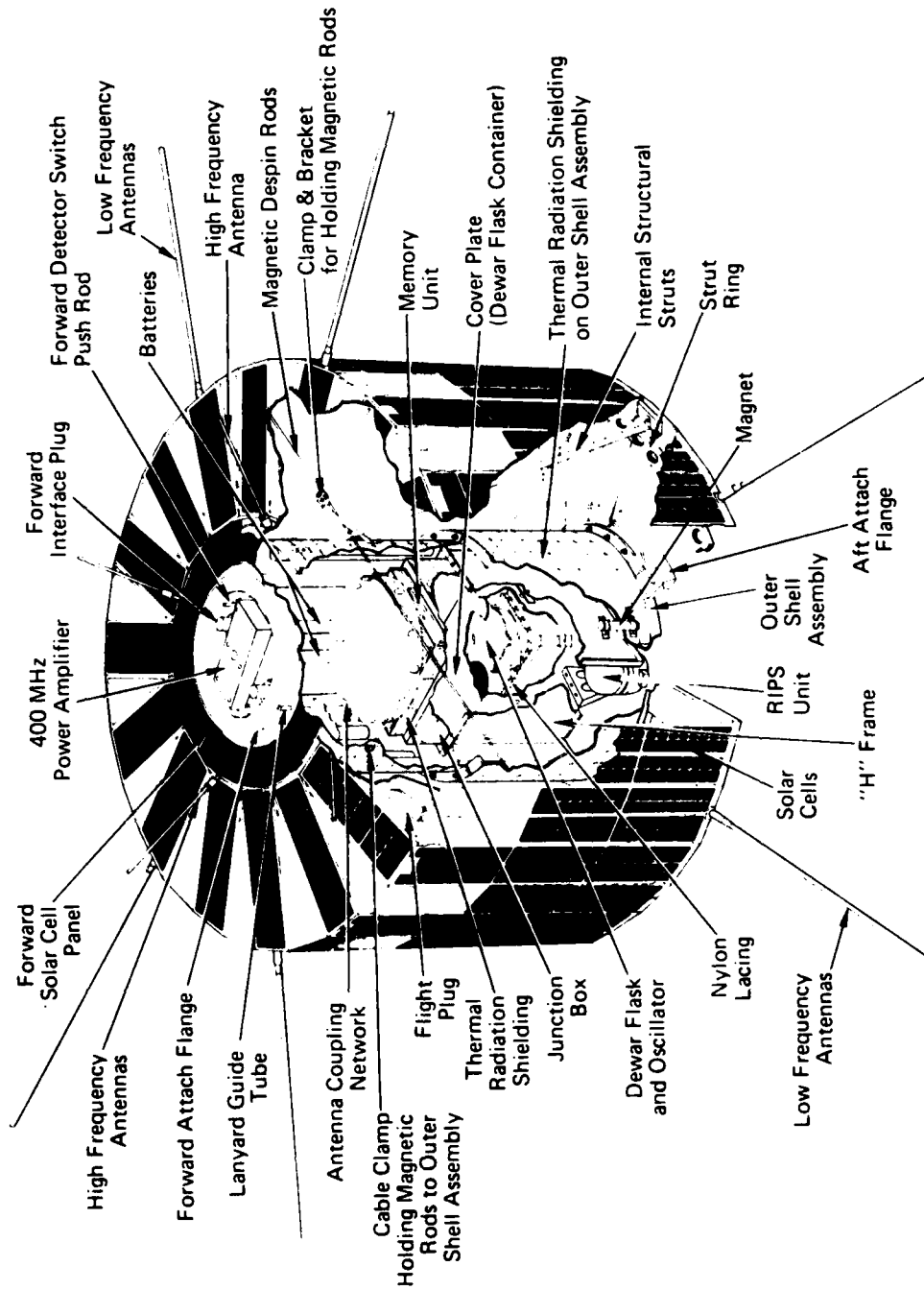

Fig. I-12 Satellite 4-A, Cutaway View

GREB III (Fig. I-13) was to separate from INJUN after receiving a 60 rpm spin-up. This spin-up/separate function was lanyard-initiated by the payload from vehicle separation. However, GREB III did not spin-up because the spin bearing jammed and as a result, INJUN and GREB III did not separate.

The satellite memory system has received many varied messages from the APL Injection and Telemetry Station and read them out unchanged. The commercially supplied telemetry transmitter on this satellite failed one month after launch. This has made complete system analysis difficult. Oscillator stability has degraded due to an apparent failure in the voltage regulator (oscillator circuit). Data gathered during periods of good oscillator stability were used in geodetic analyses. The satellite is still operating.

*Satellite 4-B (Figs. I-14 and I-15):*

Met all launch objectives. The APL-designed telemetry transmitter on 4-B was an improvement over the commercially-supplied transmitters used in the 2-A, 3-B, and 4-A satellites. The satellite memory and telemetry systems operated satisfactorily. Oscillator stability was excellent and doppler transmitter outputs nominal during the satellite's life.

On 6 June 1962, RIPS power dropped to zero, was intermittent for several days, then failed completely. It is believed that either the RIPS DC/DC converter failed, or that the RIPS thermoelectric converters in the power unit failed. The solar cells showed extremely rapid degradation as a result of a high altitude nuclear test conducted over Johnson Island in the Pacific on 9 July 1962. The satellite ceased transmitting 2 August 1962.

On 23 March 1967, TRANET Station 115, Pretoria, South Africa, reported signals on 150 MHz from a satellite later confirmed to be 4-B. Strong 54, 150, and 324 MHz signals were subsequently heard with passes lasting up to 16 minutes. A total of 133 data passes were submitted by the TRANET between days 091 and 133 (1967). The satellite responded to numerous commands during April and May. The frequency of TRANET observations then diminished, and it ceased transmitting.

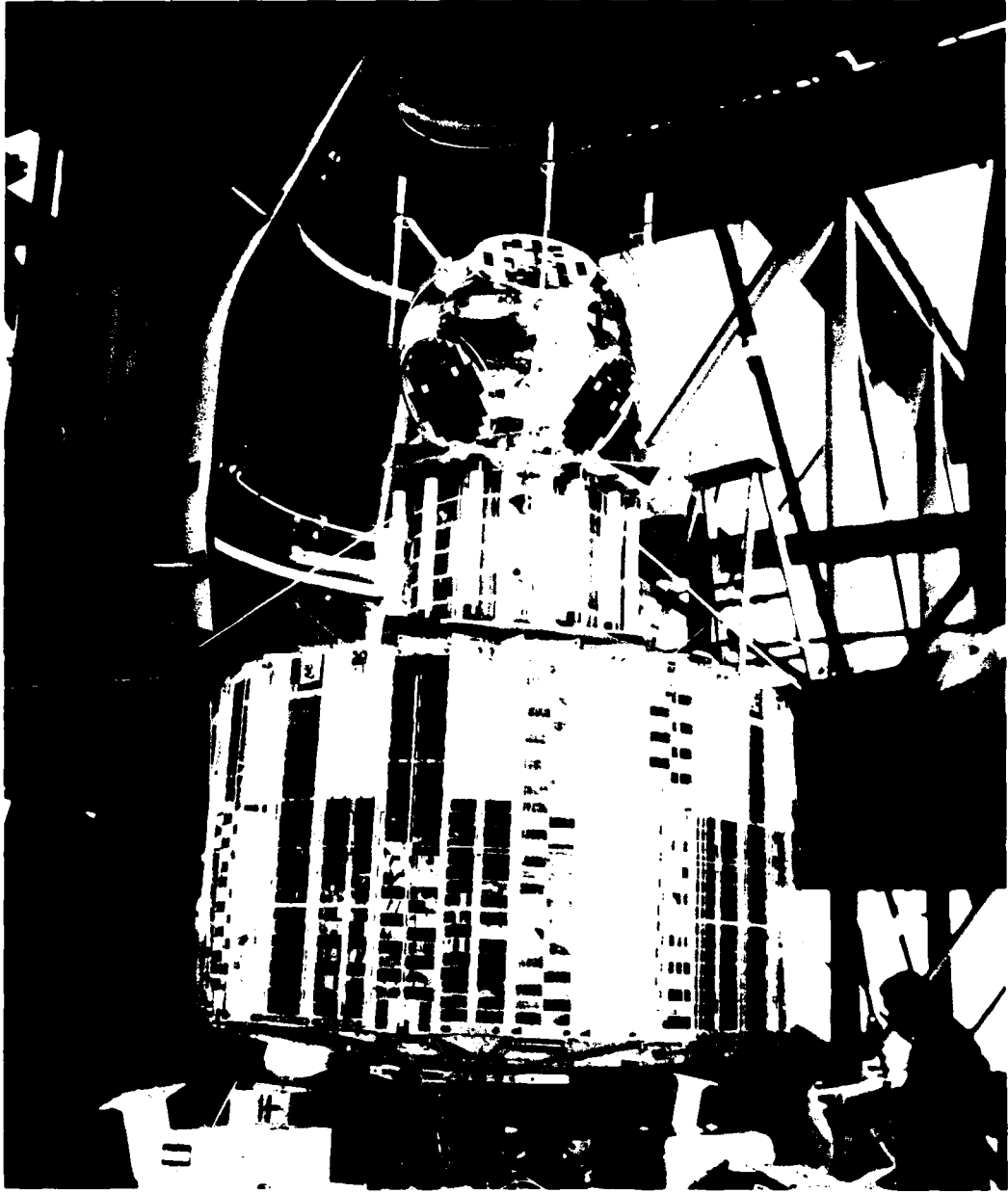

Fig. I-13 Satellite 4-A and Pickaback Satellites

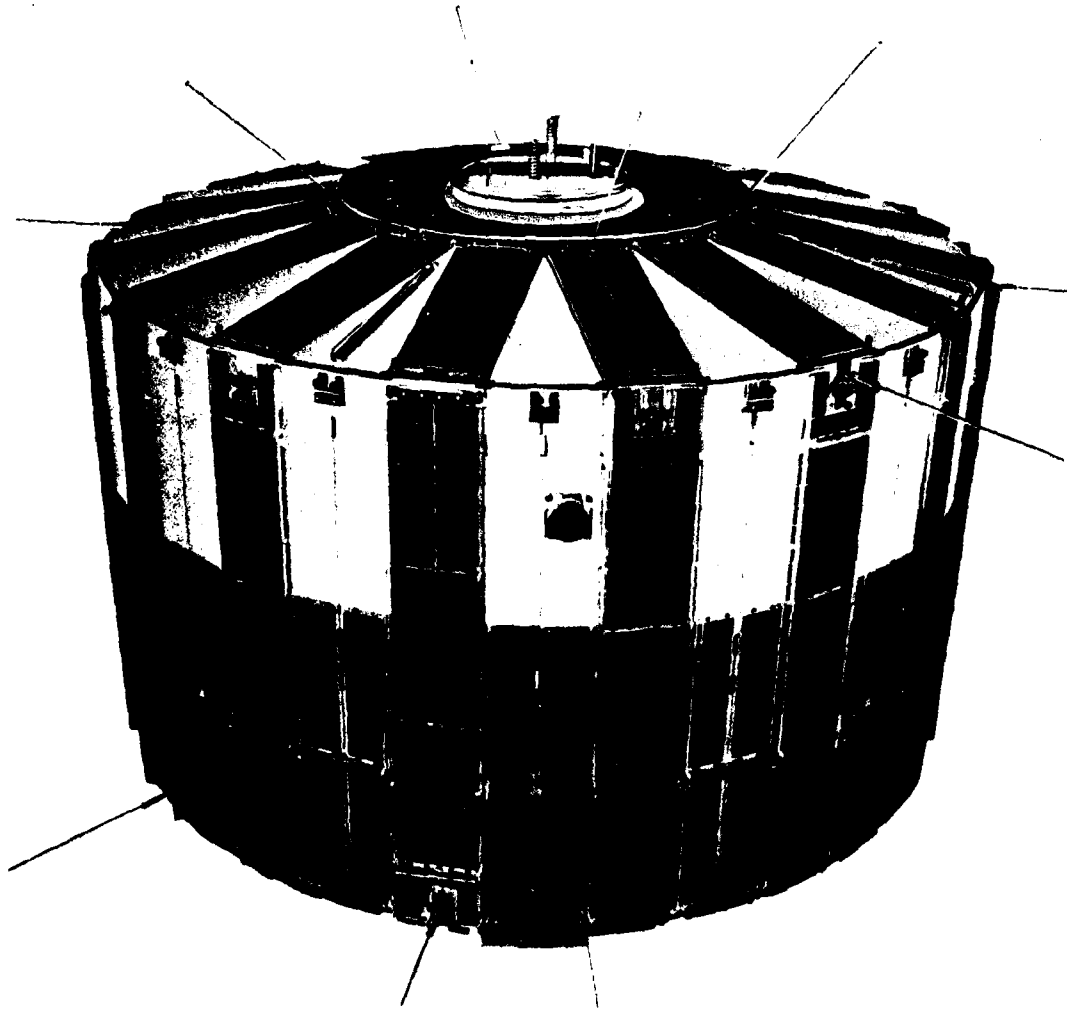

Fig. I-14 Satellite 4-B

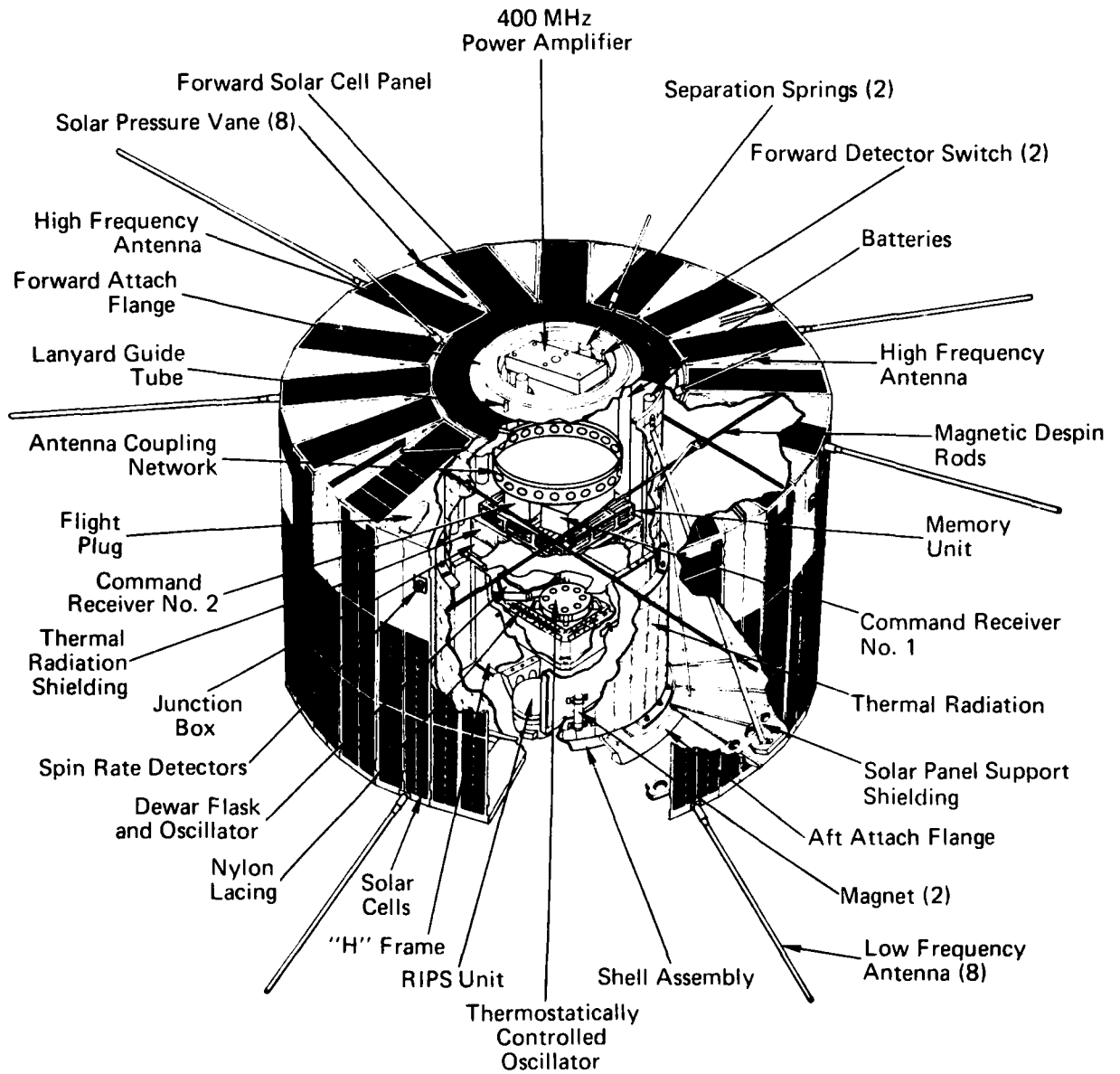

Fig. I-15 Satellite 4-B, Cutaway View

SATELLITE 5A SERIES

5A-1  
(1962 8 31)

5A-2

5A-3  
(1963 22A)

I-39

MISSING PAGE BLANK-NOT FILMED



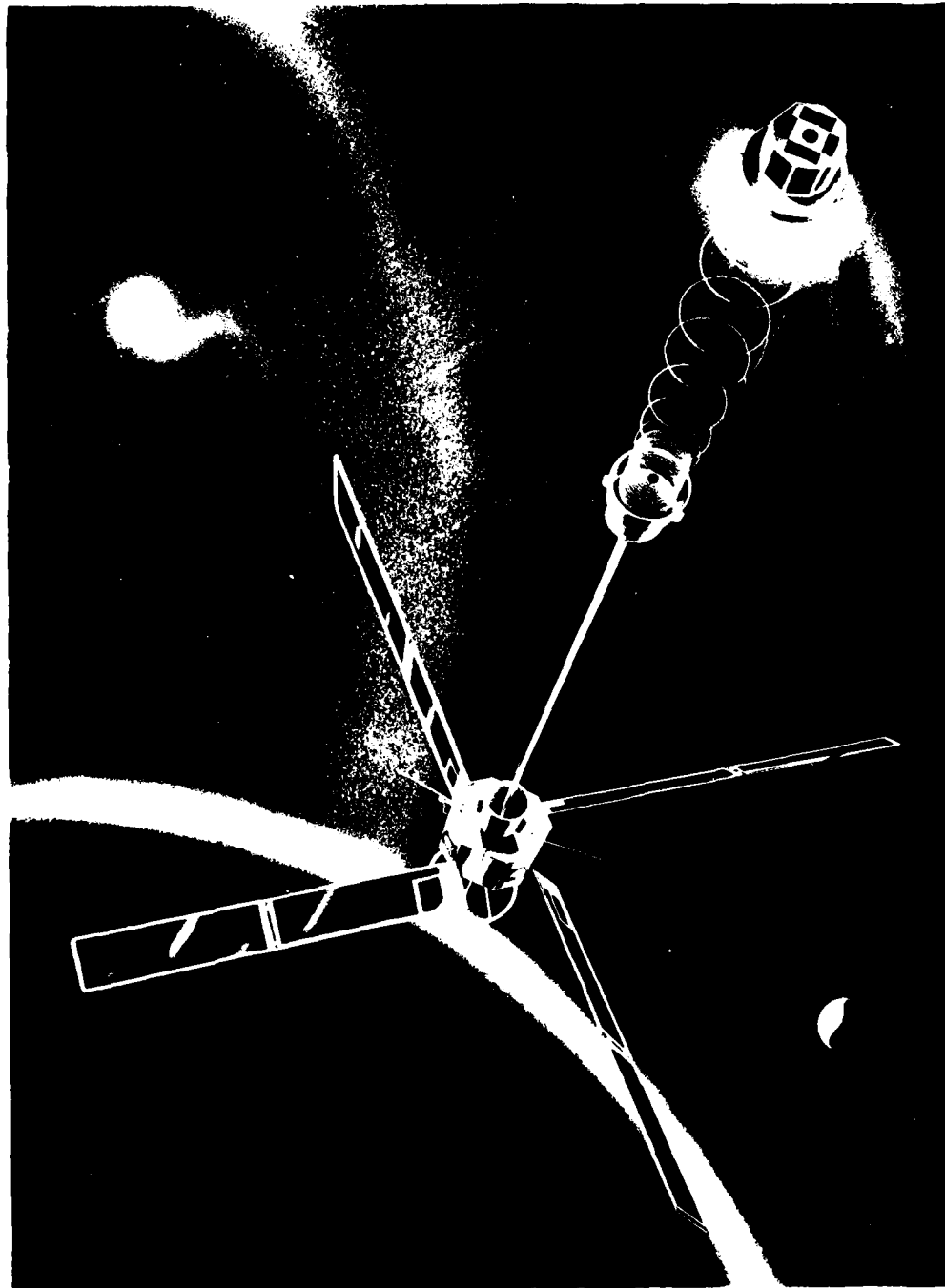

Fig. I-16 Satellite 5A-1, Artist's Concept

SATELLITE 5A SERIES

Launch: (5A-1) 18 December 1962; Vandenberg AFB, California  
(5A-2) 5 April 1963; Vandenberg AFB, California  
(5A-3) 15 June 1963; Vandenberg AFB, California

Vehicle: Scout (four stage)

Orbit: (5A-1) Apogee 737.5 km (398 nmi), perigee 700.4 km  
(378 nmi), inclination 90.7°  
(5A-2) Not achieved  
(5A-3) Apogee 774.5 km (418 nmi), perigee 726.3 km  
(392 nmi), inclination 90.03°

Remarks: Payload separation, despin, and solar blade deployment were normal on Satellites 5A-1 and 5A-3. Satellite 5A-2 did not achieve orbit due to a vehicle malfunction.

Background

The 5A satellite series, of which 5A-1 (Fig. I-16) was the first, represented a total design change for APL navigation satellites. Solar cells were mounted on four hinged blades which deployed upon orbital injection. Gravity gradient was employed as the stabilization mode. A directional antenna was located to point toward the earth once stabilization was achieved. New welded-circuit techniques were employed in memory fabrication. Electronic components were compressed in size, imbedded in potting compound, and tightly packed within a body 25% the size of all previous navigation satellites. Total weight was reduced to  $58.5 \pm 4.5$  kg ( $130 \pm 10$  lb). The bare structural weight of the vehicle adapter was less than 0.9 kg (2 lb).

The structural shell combined high thermal resistance with low electrical resistivity and had a very high strength-to-weight ratio. The inner electronic instrument support featured very high thermal isolation with a radiator base-plate of low density and great stiffness.

The 5A satellite was the first to provide its own separation signal and to employ a passive delayed-interval timer of unique design which caused the despin and separation functions to occur approximately five minutes apart. This system is still in use on all APL satellites launched by Scout.

Physical Characteristics (Fig. I-17)

- Body: Octagonal prism, 45.72 cm (18 in.) by 25.4 cm (10 in.) high
- Solar Blades: (5A-1) 121.92 cm by 25.4 cm (48 in. by 10 in.), eight double-folded blades  
(5A-2 and 5A-3) 121.92 cm by 25.4 cm, four with 40.64 cm by 25.4 cm (16 in. by 10 in.) appendage on each
- Weight: (5A-1) 58.98 kg (131.07 lb) plus 4.5 kg (10 lb) attach hardware  
(5A-2) 54.94 kg (122.08 lb) plus 4.5 kg attach hardware  
(5A-3) 54.82 kg (121.81 lb) plus 4.5 kg attach hardware.

Features (Fig. I-18)

- Two oven-controlled crystal oscillators
- Transmitters: 150/400 MHz
- Power: Solar cells/Ni-Cd batteries
- Yo-yo despin system
- Magnetic hysteresis despin system
- Gravity gradient stabilization system
- Electromagnetic stabilization system
- 24054-bit coincident current magnetic core memory and digital clock
- Telemetry: 35 channels modulating 150 MHz carrier on command
- Three axis solar attitude detector system
- Three axis fluxgate magnetometer system
- Automatic temperature control
- Cone shaped directional antenna.

Objectives

1. Provide a means by which US Navy ships could navigate anywhere in the world.

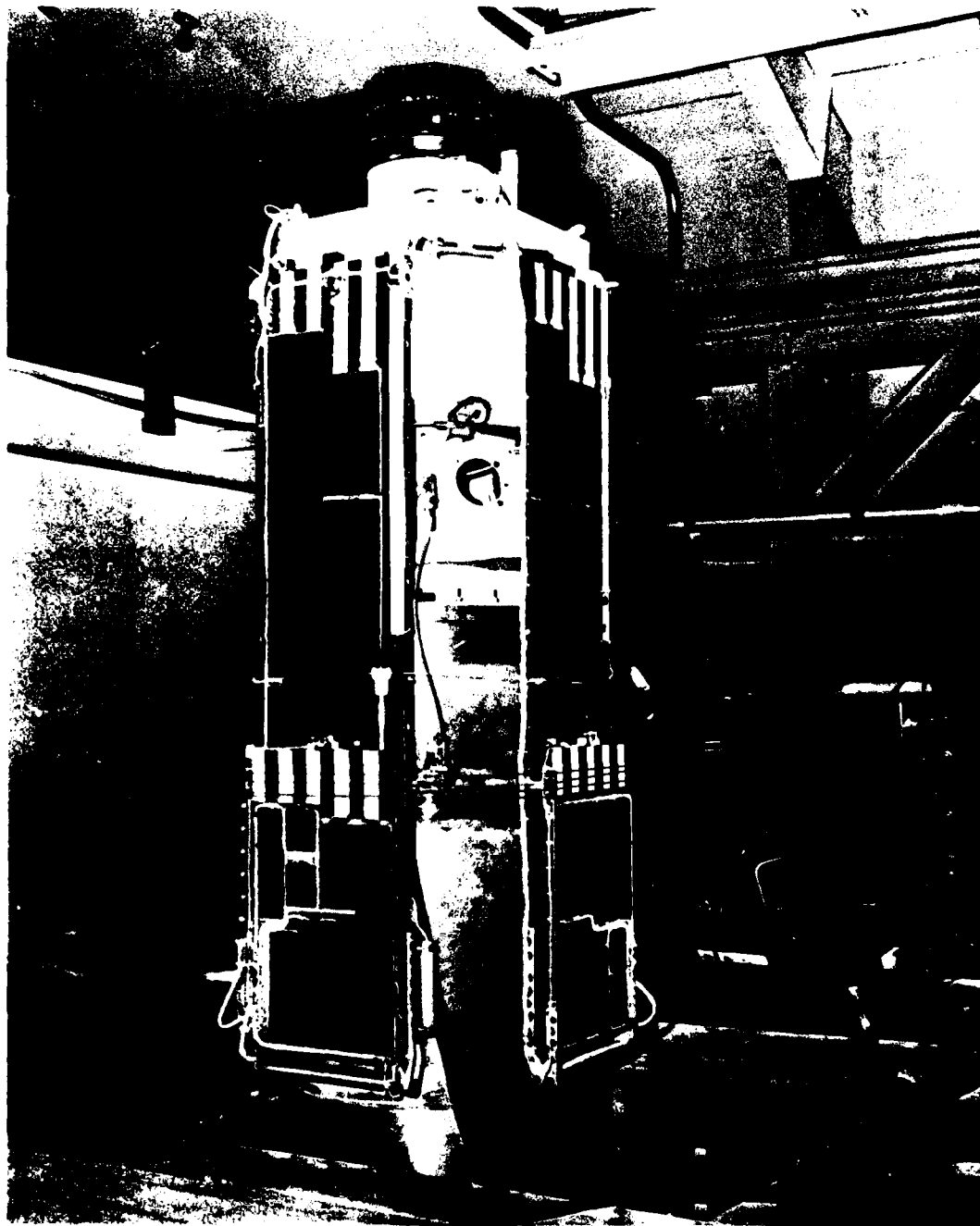

Fig. I-17 Satellite 5A-2 on Vibration Test Table

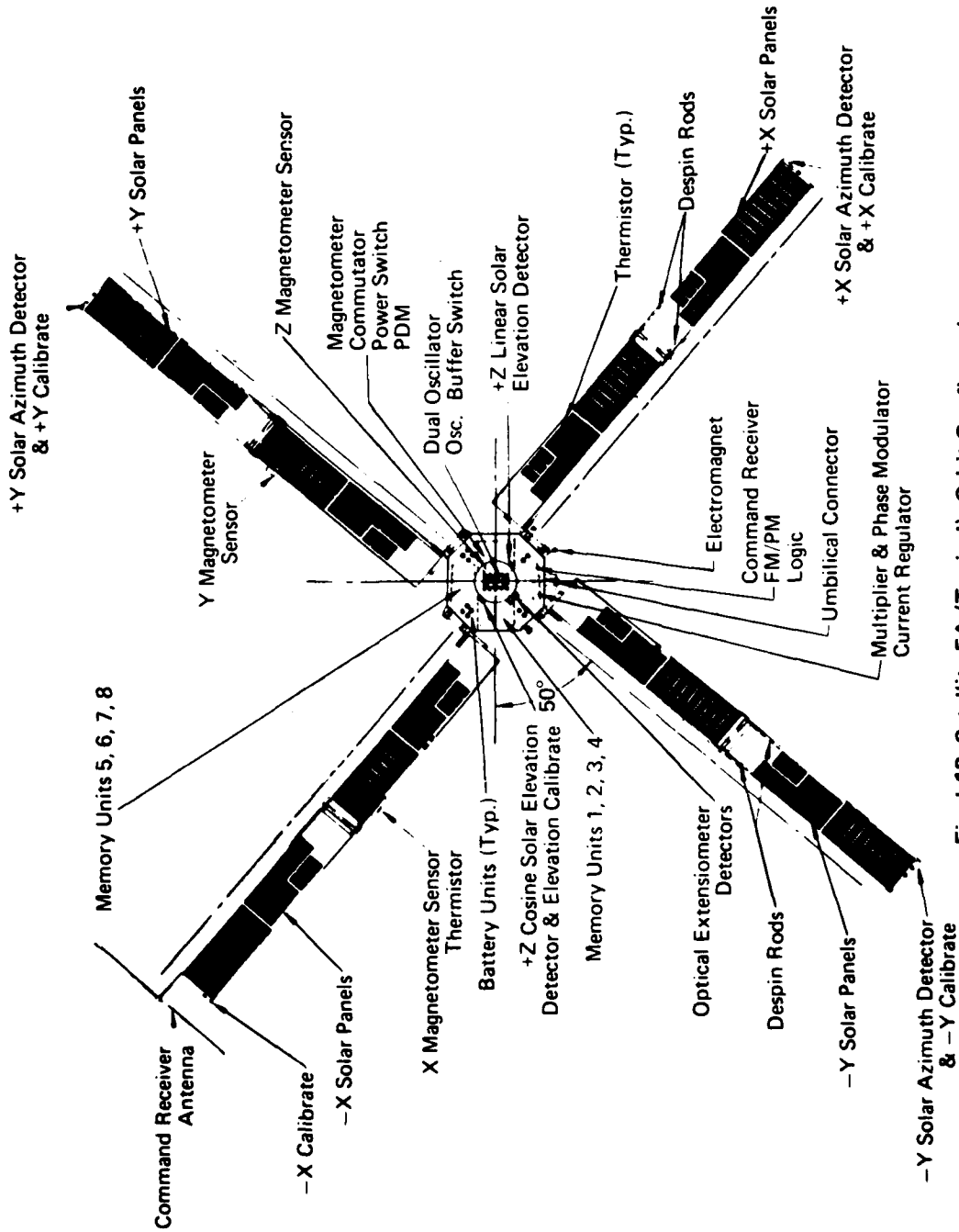

Fig. I-18 Satellite 5A (Typical), Orbit Configuration

2. Improve the understanding of the effects of ionospheric refraction on radio waves.
3. Increase knowledge of the earth's shape and gravitational field.
4. (5A-1) Demonstrate the feasibility of
  - (a) unfurling, after powered flight, an 18 foot cruciform solar array packaged to fit within a 34-inch diameter nose fairing,
  - (b) automatically pitching the solar blades with a single-degree-of-freedom spring powered hinge,
  - and (c) combining solar blades restraint and release with yo-yo despin cables.
5. Prove the feasibility of gravity gradient stabilization.

#### Achievements

##### *Satellite 5A-1:*

Objective No. 4 was met. Satellite 5A-1 became inoperable on 19 December 1962, about 20 hours after launch, so that Objective Nos 1, 2, 3, and 5 were not met. Satellite failure was due to excessive battery charging apparently caused by an overstress in the limiting circuit of the solar charge current.

##### *Satellite 5A-2:*

All satellite systems performed perfectly during powered flight. Doppler transmitter signals were strong, telemetry good, and the satellite memory read out its launch test pattern perfectly to the end of flight. Since orbit was not achieved, the test objectives could not be met.

This satellite was both structurally and functionally similar to 5A-1. The notable exception was in the length of the second section of each solar blade. These sections were one-third as large as those employed on 5A-1. Satellite 5A-2 would have measured but 12 feet tip-to-tip in orbit. In all other respects 5A-2 was identical to 5A-1.

##### *Satellite 5A-3:*

Objective Nos 2 and 4 were met. Objective No. 1 was not met because the ephemeral portion of the satellite memory could not be loaded with navigation information.

The malfunction which precluded this loading occurred during powered flight. Objective No. 3 was not met due to oscillator stability degradation subsequent to launch. The rms oscillator values of 1 part in  $10^{10}$  and 8 parts in  $10^{11}$  were measured shortly before launch.

Satellite 5A-3, identical to 5A-2, was the first artificial earth satellite to achieve the gravity gradient stabilization which was known to be theoretically possible, but widely believed to be unattainable. Deflection of the "lossy" spring which provided libration damping was detected by an optical sensor on the satellite body viewing a solar-powered flashing light at the end of the gravity gradient stabilization boom libration damping spring (lossy).

This satellite provided the first orbital demonstration of an automatic temperature control (ATC) system later used in a number of APL satellites. The 5A-3 ATC system continues to operate satisfactorily.

Both satellite doppler transmitters continue to operate.

THE JOHNS HOPKINS UNIVERSITY  
APPLIED PHYSICS LABORATORY  
LAUREL MARYLAND

SDO 1600  
May 1975

SATELLITE 5BN SERIES

5BN-1  
(1963 38B)

5BN-2  
(1963 49B)

5BN-3



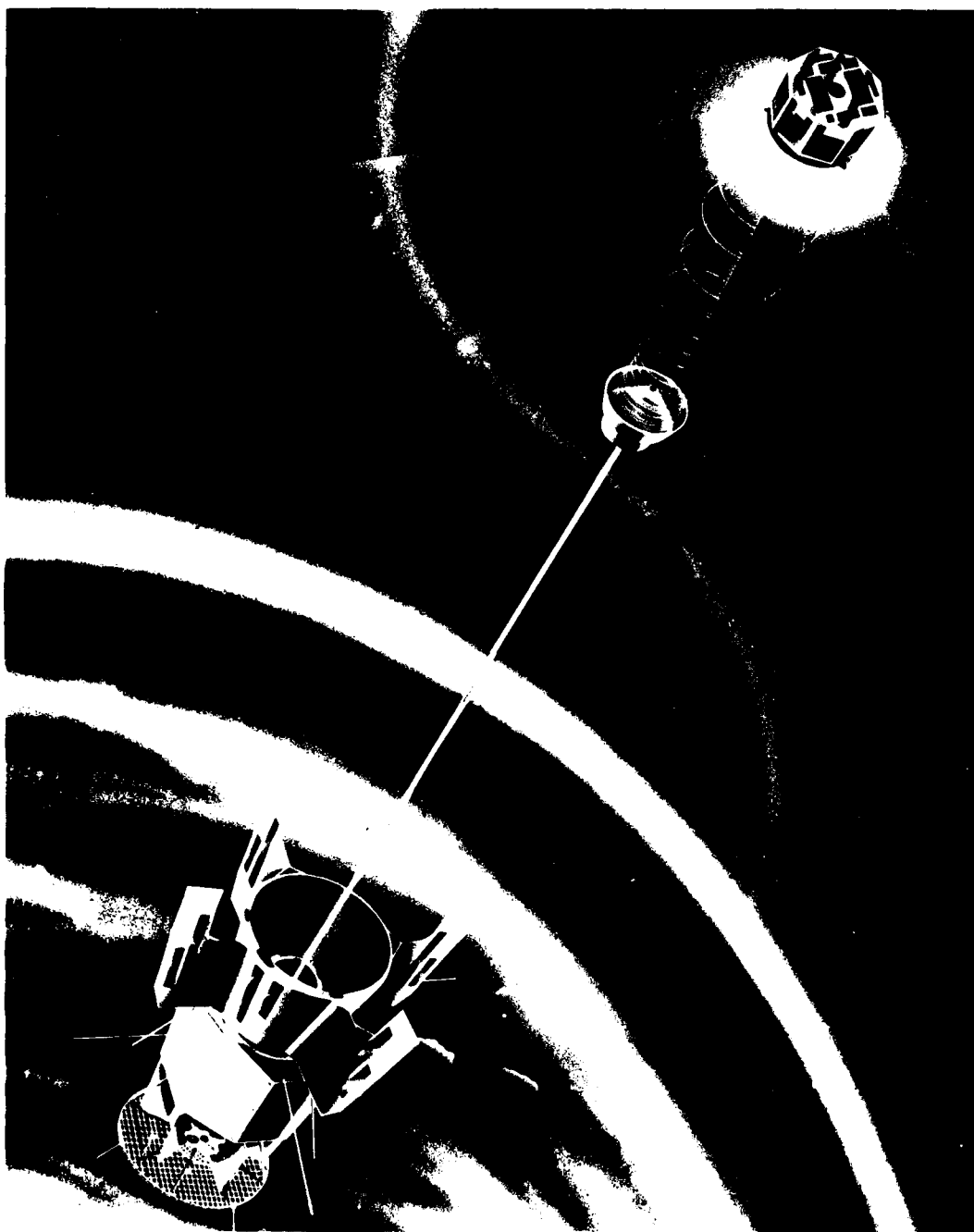

Fig. I-19 Satellite 5BN-1, Artist's Concept

SATELLITE 5BN SERIES

Launch: (5BN-1) 28 September 1963; Vandenberg AFB, California  
(5BN-2) 6 December 1963; Vandenberg AFB, California  
(5BN-3) 21 April 1964; Vandenberg AFB, California

Vehicle: Thor-Able-Star (two stage)

Orbit: (5BN-1) Apogee 1128.4 km (609 nmi), perigee  
1078.4 km (582 nmi), inclination 89.94°  
(5BN-2) Apogee 1108 km (598 nmi), perigee  
1078.4 km, inclination 89.9°  
(5BN-3) Not achieved

Remarks: All satellites carried pickaback payloads;  
Satellite 5BN-1 separated from Satellite 5E-1  
normally, and Satellite 5BN-2 separated from  
Satellite 5E-3 normally. Satellite 5BN-3 with  
Satellite 5E-2 failed to achieve orbit. The  
pickaback satellites are described elsewhere  
in this document.

Background

The 5BN series of navigation satellites employed radioisotope power supplies for all primary power requirements. The series consisted of Satellites 5BN-1, 5BN-2, and 5BN-3.

Physical Characteristics (Fig. I-19)

Body: Octagonal prism, 45.72 cm (18 in.) across by  
30.48 cm (12 in.) high

SNAP 9-A: Cylinder 30.48 cm dia. by 20.32 cm (8 in.)  
high (four radiating fins on side)

Aft Skirt Fins (4): 45.72 cm by 30.48 cm

Weight: (5BN-1) 69.30 kg (154 lb)  
(5BN-2) 74.70 kg (166 lb)  
(5BN-3) 75.11 kg (166.9 lb)

### Features (Fig. I-20)

Two oven controlled crystal oscillators

Transmitters: 136, 150, and 400 MHz

Power: SNAP 9-A radioisotope nuclear generator; solar cells/Ni-Cd batteries powered the 136 MHz (TM) auxiliary system

Magnetic hysteresis despin system

Chargeable-magnet stabilization system

Gravity gradient stabilization system

24054-bit coincident current magnetic core memory and digital clock

Telemetry: 35 channels modulating the 150 MHz signal on command or automatically for two minutes following memory load operation

Three axis solar attitude detector system

Three axis fluxgate magnetometer system

Directional whip and ground plane antenna system.

### Objectives

1. Provide a means by which US Navy ships may navigate anywhere in the world.
2. Demonstrate satisfactory operation of all satellite subsystems.
3. Demonstrate satisfactory operation and potential long life capability of the SNAP 9-A power supply.
4. Improve understanding of the effects of ionospheric refraction on radio waves.
5. Demonstrate satisfactory operation of the satellite-borne data injection memory system.
6. Increase knowledge of the earth's shape and gravitational field.

### Achievements

*Satellite SBN-1 (Fig. I-21):*

Objective Nos 3, 4, and 5 were fully satisfied. Objective Nos 1, 2, and 6 were partially achieved in that all subsystems operated perfectly for the life of the satellite; navigation was accomplished and geodetic data were gathered.

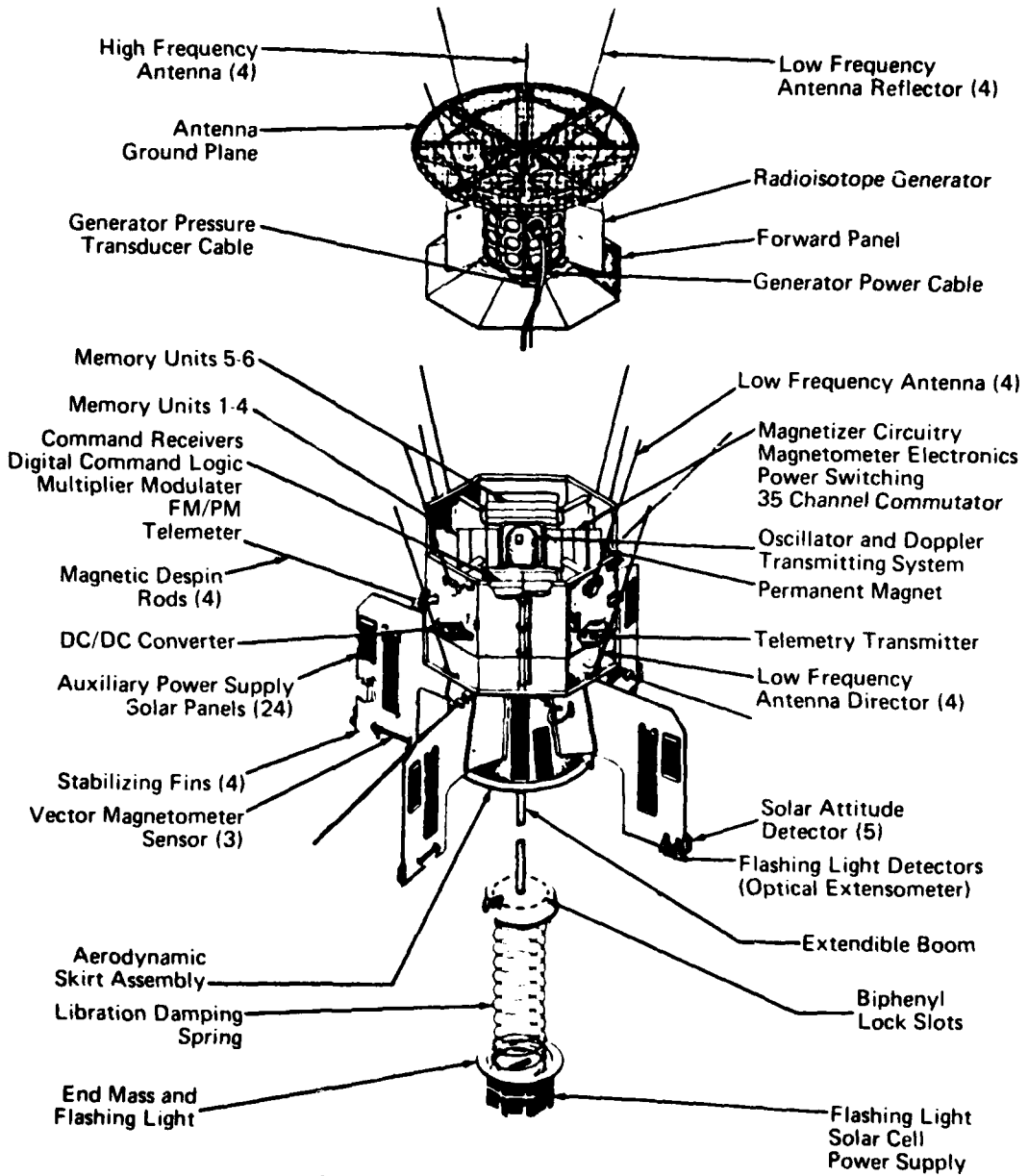

Fig. I-20 Satellite 5BN (Typical), Exploded View

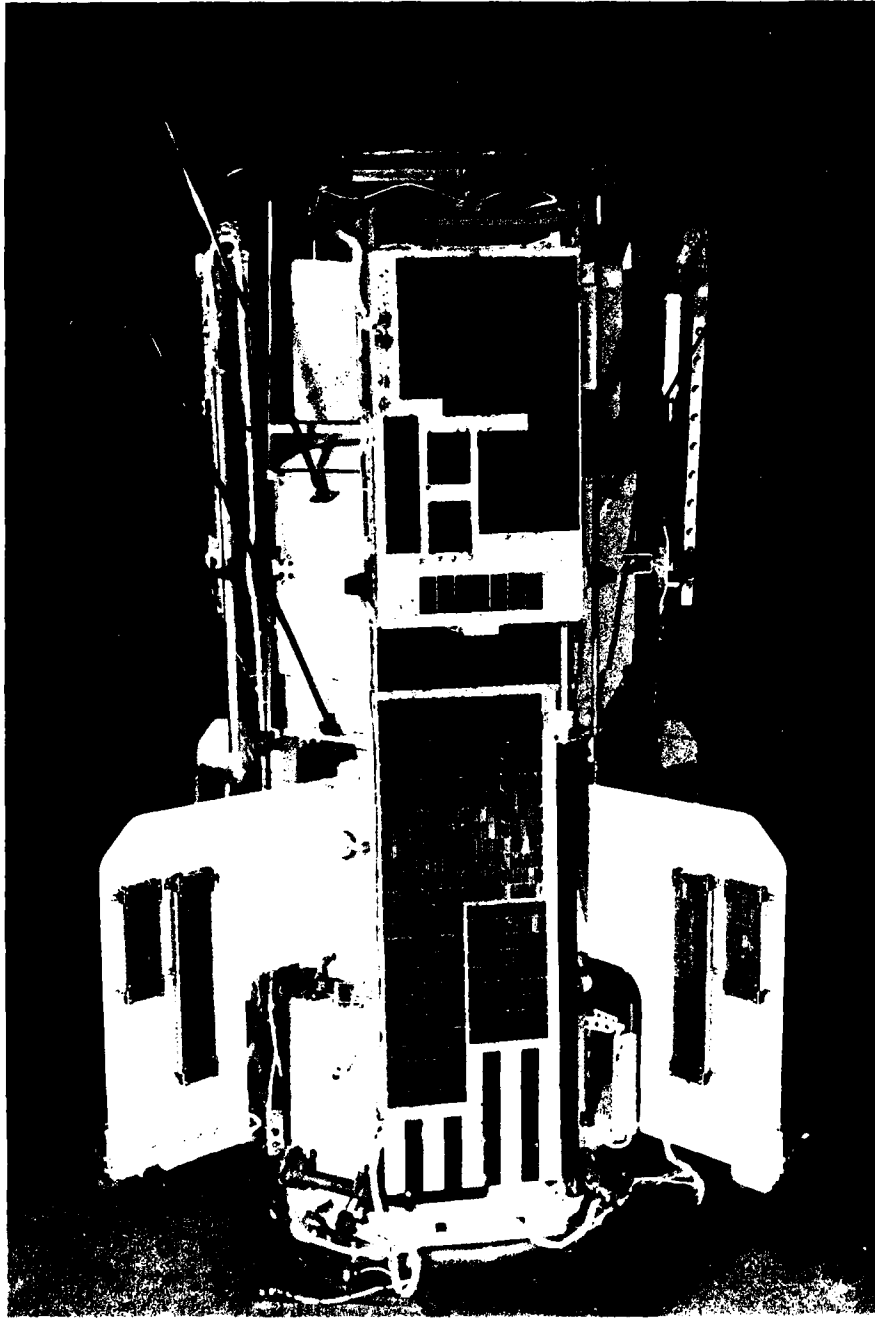

Fig. I-21 Satellite 5BN-2 Atop Satellite 5E-3

On 22 December 1963 the satellite ceased transmitting on 150 and 400 MHz. Data from the 136 MHz auxiliary telemetry system indicated that a short circuit had developed either in one of the satellite wiring harnesses or in the electronics. The excess load caused all outputs from the SNAP 9-A converter to be depressed to levels that were not sufficiently high to operate the doppler transmitters. The auxiliary telemetry system provided engineering data on the SNAP 9-A performance under this heavy load until 1 June 1964 when telemetry data were last obtained.

Satellite 5BN-1 was the first artificial earth satellite to employ nuclear energy as its primary power source. The satellite was stabilized by means of a gravity gradient system. In her role as a pioneer nuclear satellite, 5BN-1 demonstrated the extreme simplicity with which thermoelectric generators may be integrated into the design, not only to provide the electrical power but also to aid in thermal control.

All APL satellite navigational concepts were validated using Satellite 5BN-1.

The satellite assumed an inverted orientation of the gravity gradient because of the thrust of subliming biphenyl at the end of the 100-foot boom. This resulted in a 25 dB reduction in the satellite signal strength received on earth.

Four fins were located with respect to the satellite center of mass so as to insure complete SNAP 9-A burnup in the event of either reentry consequent upon a decaying orbit, or the inability of the vehicle to achieve orbit during powered flight.

*Satellite 5BN-2:*

All launch objectives were met. This was the first truly operational navigation satellite. The satellite was in nearly continuous use by the US Navy surface and submarine forces until November 1964. The satellite memory then exhibited some anomalous behavior and, as a result, 5BN-2 was useful for navigation approximately only 75% of the time. During periods in which the ratio of solar illumination to darkness was high, the memory temperature exceeded 100°F and caused the quality of the satellite time system to be inadequate for navigation. Conditions deteriorated and all navigational capacity ceased on 14 July 1965. The satellite continues to furnish good SNAP 9-A telemetry data.

*Satellite 5BN-3:*

Boost vehicle ground guidance generated erroneous steering commands, thus placing the vehicle off the correct flight path. However, an important item of the launch test objective was met. Since reentry appeared to have vaporized the generator, the safety features incorporated in the design of SNAP 9-A/5BN were shown to be satisfactory.

Payload telemetry recovered from the satellite tracking station at Pretoria, South Africa, indicated that the Able-Star had separated both payloads properly, that the 5BN-3 had in turn separated from the 5E-2, and that the 5E-2 solar blades had deployed prior to reentry.

THE JOHNS HOPKINS UNIVERSITY  
APPLIED PHYSICS LABORATORY  
LAUREL MARYLAND

SDO 1600  
May 1975

SATELLITE 5C-1  
(1964 26A)



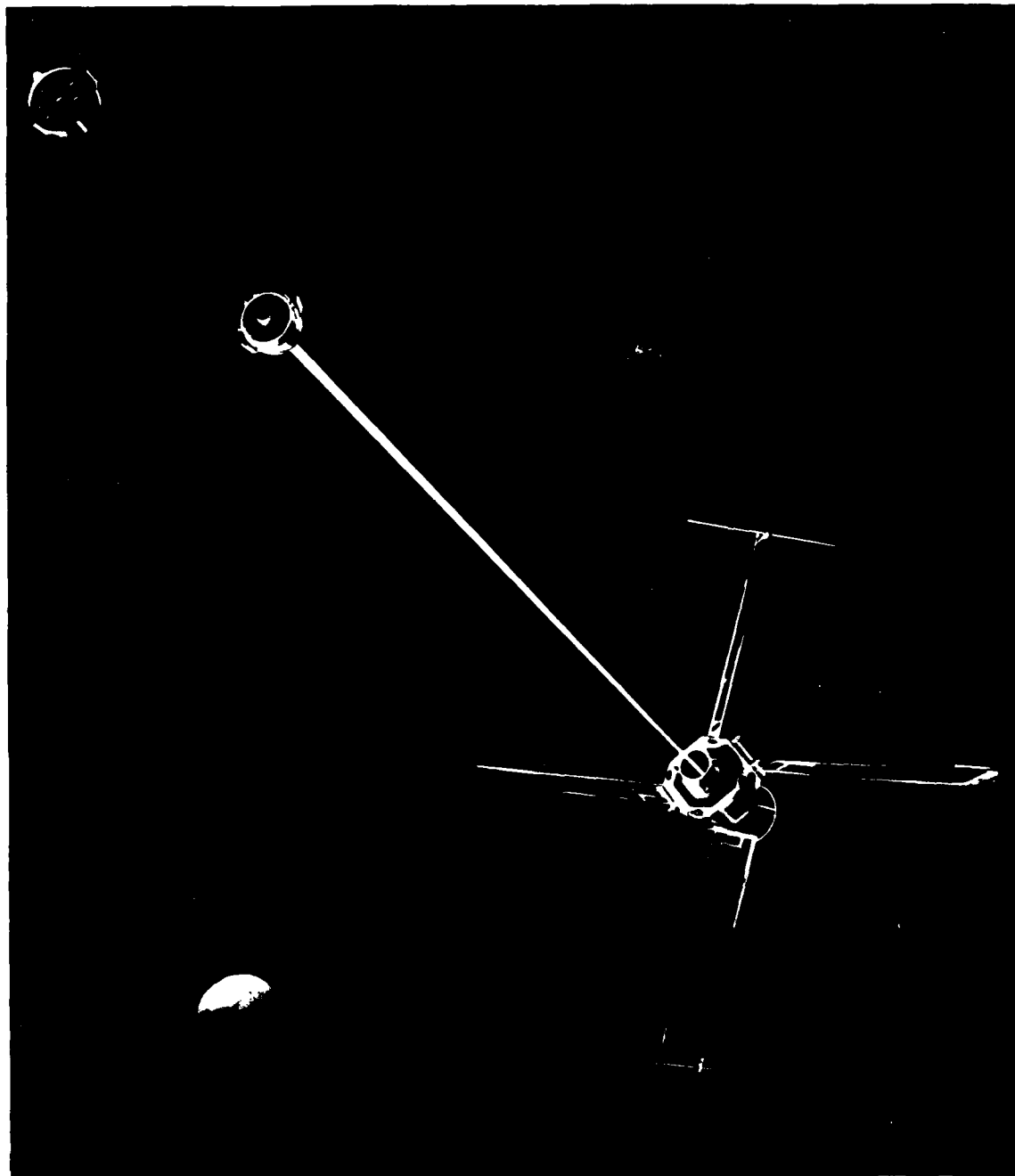

Fig. I-22 Satellite 5C-1, Artist's Concept

SATELLITE 5C-1

Launch: 3 June 1964; Vandenberg AFB, California  
Vehicle: Scout (four stage)  
Orbit: Apogee 958 km (517 nmi), perigee 850.5 km  
(459 nmi), inclination 90.57°  
Remarks: Despin, separation, and solar blade deployment  
normal.

Physical Characteristics (Fig. I-22)

Body: Octagonal prism, 45.72 cm (18 in.) across by  
25.4 cm (10 in.) high  
Solar Blades (4): Cells mounted on 167.64 cm (66 in.)  
by 25.4 cm (10 in.) substrates  
Weight: 53.78 kg (119.5 lb); attach hardware 6.75 kg  
(15 lb).

Features (Figs. I-23 and I-24)

Two oven-controlled crystal oscillators (4 parts in  $10^{11}$   
and 6 parts in  $10^{11}$ )  
Transmitters: 150 and 400 MHz  
Power: Solar cells/Ni-Cd batteries/thermal sensing charge  
control  
Yo-yo despin system  
Magnetic hysteresis despin system  
Gravity gradient stabilization system  
Electromagnetic stabilization system  
24054-bit coincident current magnetic core memory and  
digital clock  
Telemetry: 35 channels modulating the 150 MHz signal  
on command or automatically for two minutes following  
memory injection  
Three axis solar attitude detector system  
Three axis fluxgate magnetometer system  
Automatic temperature control  
Cone shaped directional antenna.

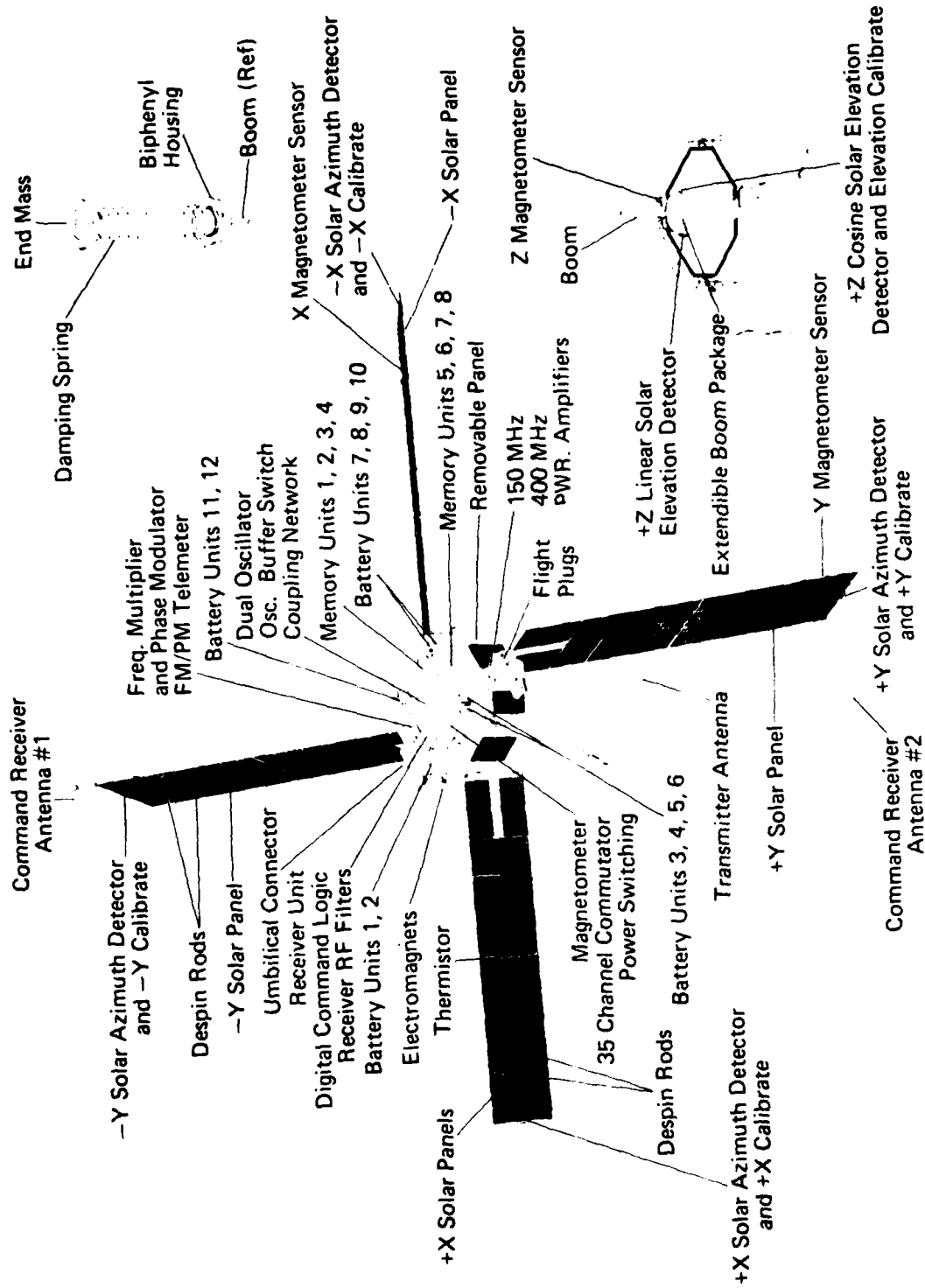

Fig. 1-23 Satellite 5C-1, Cutaway View

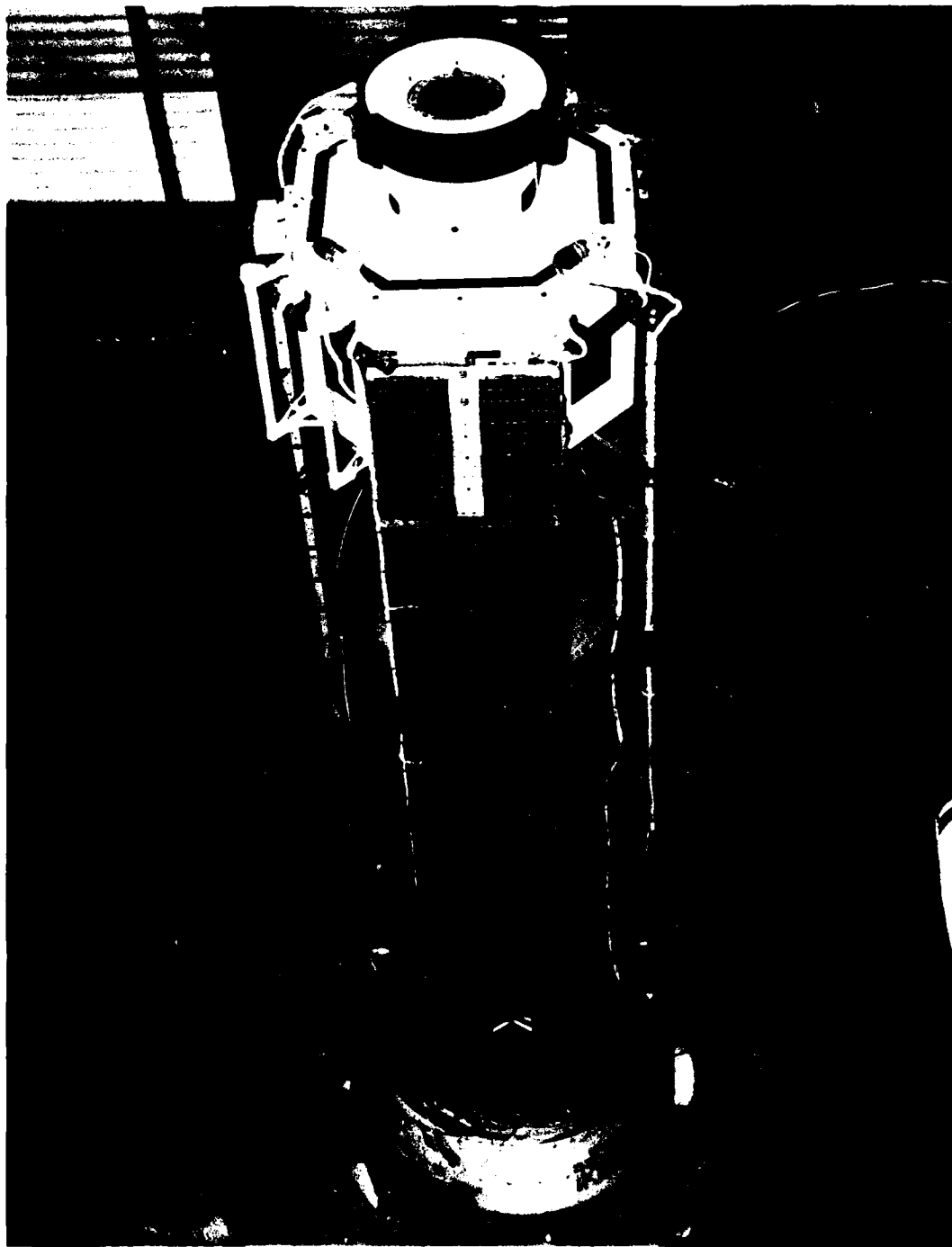

Fig. I-24 Satellite 5C-1 During Vibration Test

### Objectives

1. Enhance the US Navy global satellite navigation capability.
2. Verify the adequacy of the 5C-1 satellite and the design of the operational navigation satellites, of which 5C-1 was the prototype.

### Achievements

Satellite 5C-1 met all launch objectives and functioned satisfactorily as a navigation satellite until it ceased transmitting on 23 August 1965.

For the first 14 days after boom erection, the satellite employed 0.6 lb of passive magnetic hysteresis rods to damp the gravity librations. Peak angle with respect to the local vertical after the first five days was  $10^{\circ}$ . Although the spring deployed 14 days after boom erection as planned, this test showed that small, lightweight magnetic hysteresis damping rods were adequate for removing the librations of a gravity gradient stabilized satellite. It was concluded that the spring was unnecessary and is therefore no longer used in navigation satellites.

OSCAR SATELLITE SERIES

Oscar 4  
(1965 48C)

Oscar 10  
(1966 76A)

Oscar 6  
(1965 109A)

Oscar 12  
(1967 34A)

Oscar 8  
(1966 24A)

Oscar 13  
(1967 48A)

Oscar 9  
(1966 41A)

Oscar 14  
(1967 92A)

Oscar 11/TRANSAT  
(1977 106A)

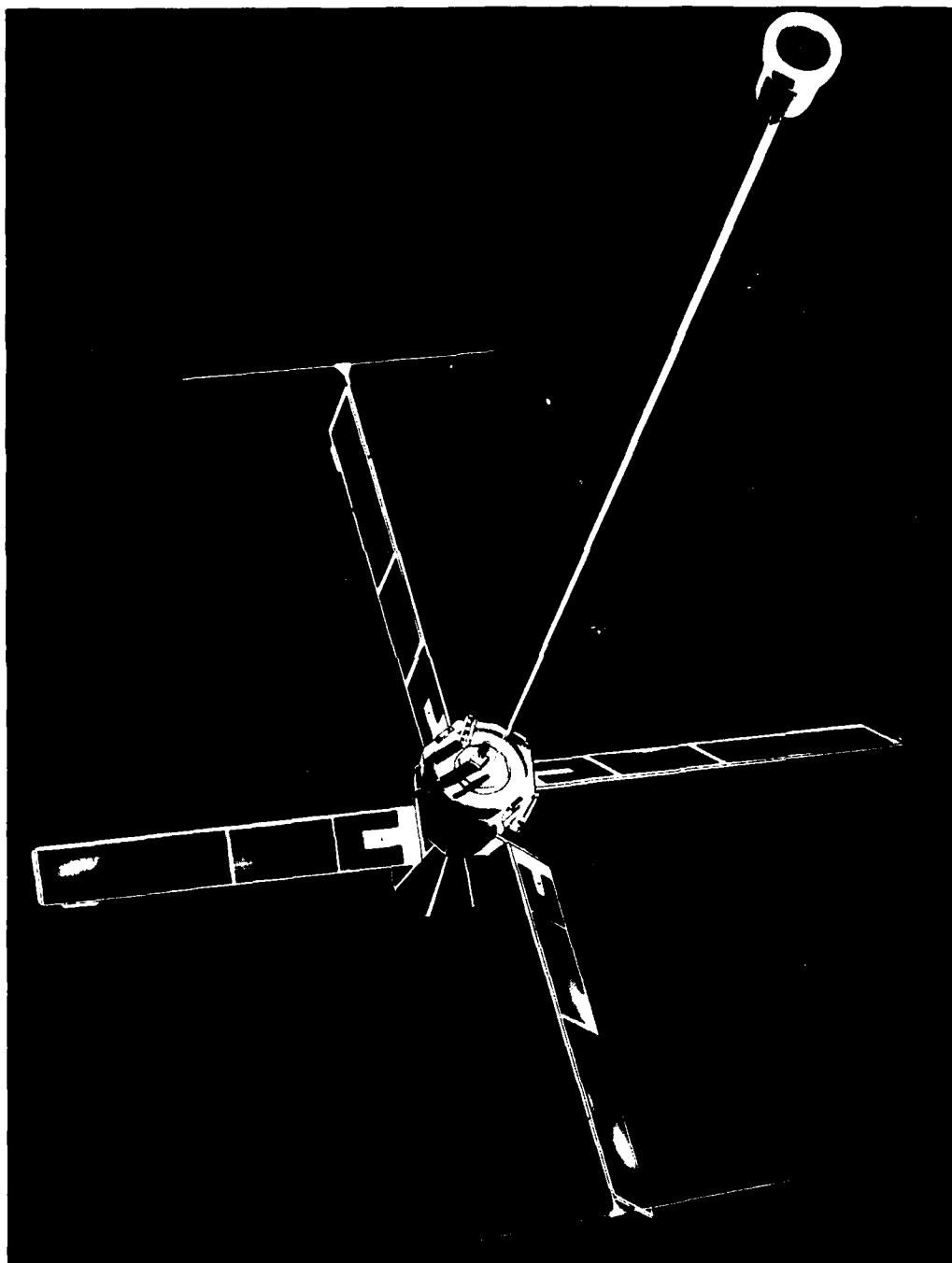

Fig. I-25 Operational (Oscar) Navy Navigation Satellite, Artist's Concept

OSCAR SATELLITE SERIES

**Launch:** All Oscars (Fig. I-25) were launched from Vandenberg AFB, California:

Oscar 4 - 24 June 1965	Oscar 10 - 18 Aug 1966
Oscar 6 - 22 Dec 1965	Oscar 12 - 14 Apr 1967
Oscar 8 - 25 Mar 1966	Oscar 13 - 18 May 1967
Oscar 9 - 19 May 1966	Oscar 14 - 25 Sept 1967

In addition, Oscar 11/TRANSAT was launched on 28 Oct 1977. This dual purpose satellite is described in the following article.

**Vehicle:** Thor-Able-Star (two stage) - Oscar 4 only; the Scout (four stage) was used to launch all other Oscars.

**Orbit:** As listed in Table I-1

**Remarks:** Despin, solar blade deployment, and separation were normal for all Oscar satellites.

Table I-1  
Oscar Satellite Orbits

Satellite	Apogee (km)	Perigee (km)	Inclination (deg)
Oscar 4	1328.6	1026.6	90.0
Oscar 6	904.3	902.4	89.1
Oscar 8	1122.9	893.1	89.7
Oscar 9	974.7	865.3	89.8
Oscar 10	1111.8	1045.1	88.9
Oscar 11	1108.1	1069.2	89.9
Oscar 12	1087.7	1039.5	90.2
Oscar 13	1104.4	1067.3	89.6
Oscar 14	1113.6	1039.5	89.2



## Background

Satellites of the Oscar (operational) Navy Navigation Satellite System (also known as Transit) employ system designs similar to those used in the 5A satellite series and checked out on Satellite 5C-1. The following early Oscar satellites, based on the APL design, were built and launched by the Naval Avionics Facility Indianapolis (NAFI):

<u>Satellite</u>	<u>Launch Date</u>	<u>Status</u>
Oscar 1	6 Oct 1964	Ceased transmitting 6 Oct 1964
Oscar 2	12 Dec 1964	Ceased transmitting 31 Dec 1964
Oscar 3	11 Mar 1965	Failed to orbit
Oscar 5	13 Aug 1965	Operational 20 Aug - 3 Oct 1965
Oscar 7	28 Jan 1966	Operational 2 Feb - 25 Mar and 30 Mar - 10 Apr 1966.

Oscar 4, Oscar 6, and Oscar 8 through Oscar 16 were fabricated by APL. Of these, Oscar 15 was modified to become the P76-5 satellite (see separate article under Ionospheric Research Satellites) and Oscar 16 is in long-term storage at the RCA Astro Electronics Division, which was selected to provide industrial support in the fabrication of the Oscar 18 and subsequent satellites. Oscar 17 was not assembled. This article discusses the Oscar satellites fabricated and launched by APL.

## Physical Characteristics (Fig. I-26)

Body: Octagonal prism, 45.7 cm across flats by 25.4 cm high

Solar Blades (4): Cells mounted on 167.6 cm by 25.4 cm substrates

Weight: 50.8 kg (typ.)

## Features

The center structure of a Navy Navigation Satellite is shown in Fig. I-27, and a system block diagram is shown in Fig. I-28. Table I-2 summarizes the main characteristics of the Oscar navigation satellites. Oscar 14 also included a pneumatic timer experiment consisting of a passive delay actuator (PDA) and a 136.8 MHz PCM/FM/PM single-channel Telepack system which was attached to the satellite adapter. Refer to Appendix B for a functional description of the Navy Navigation Satellite System. Table C-1 (Appendix C) provides a bibliography on the system, including geodetic studies.

Table 1-3 lists the stabilities of the oven-controlled crystal oscillators for the APL-fabricated Oscar satellites.

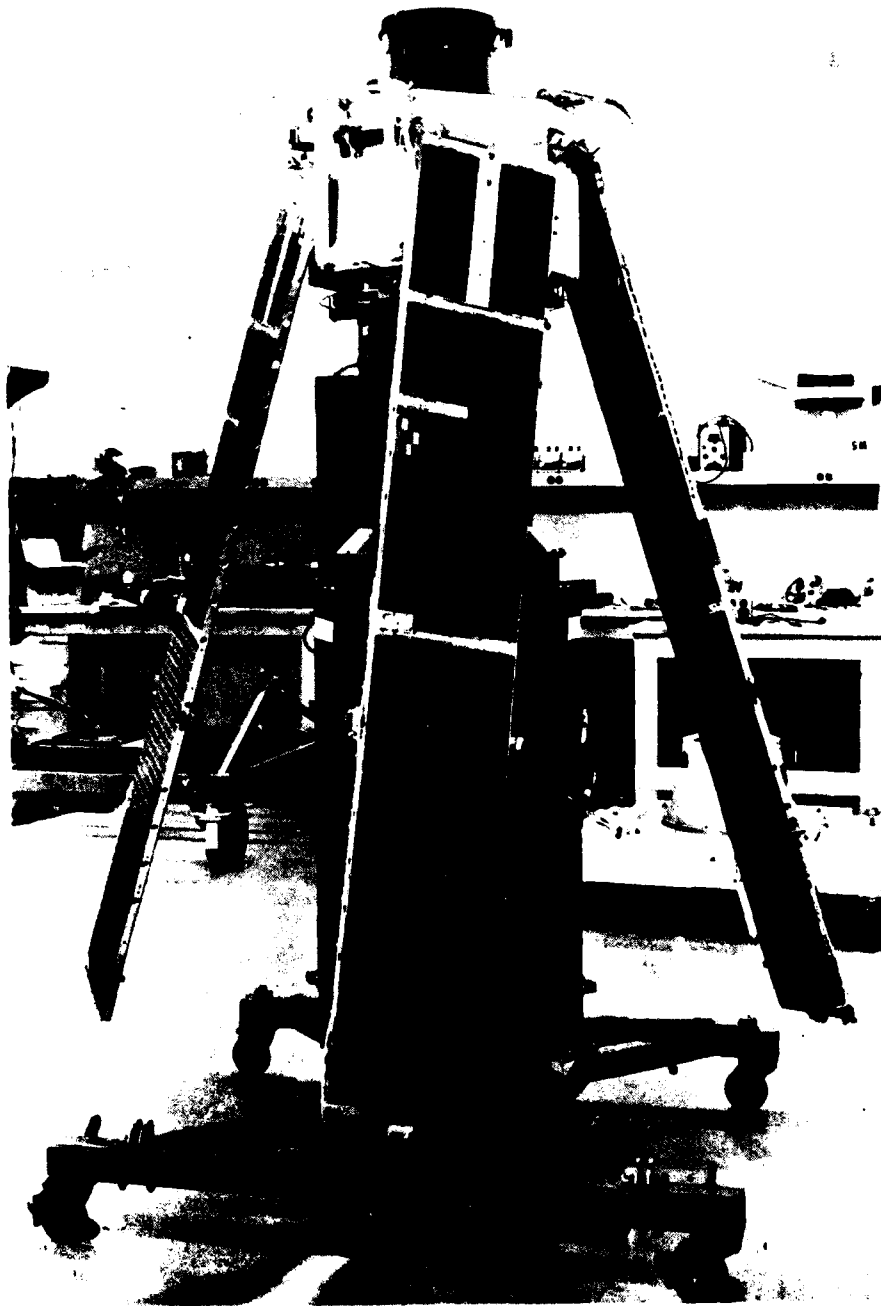

Fig. I-26 Oscar 4 Satellite

I-65

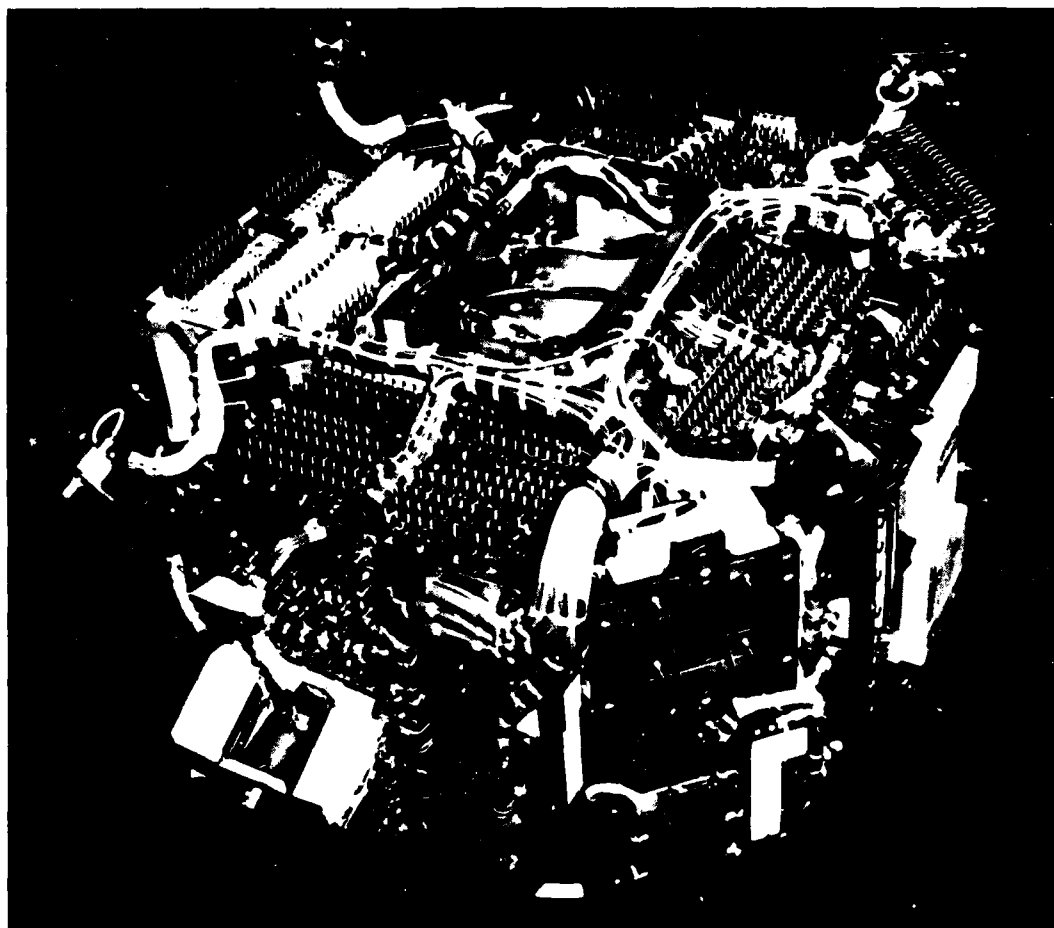

Fig. I-27 Interior View of Navy Navigation Satellite (Oscar 6)

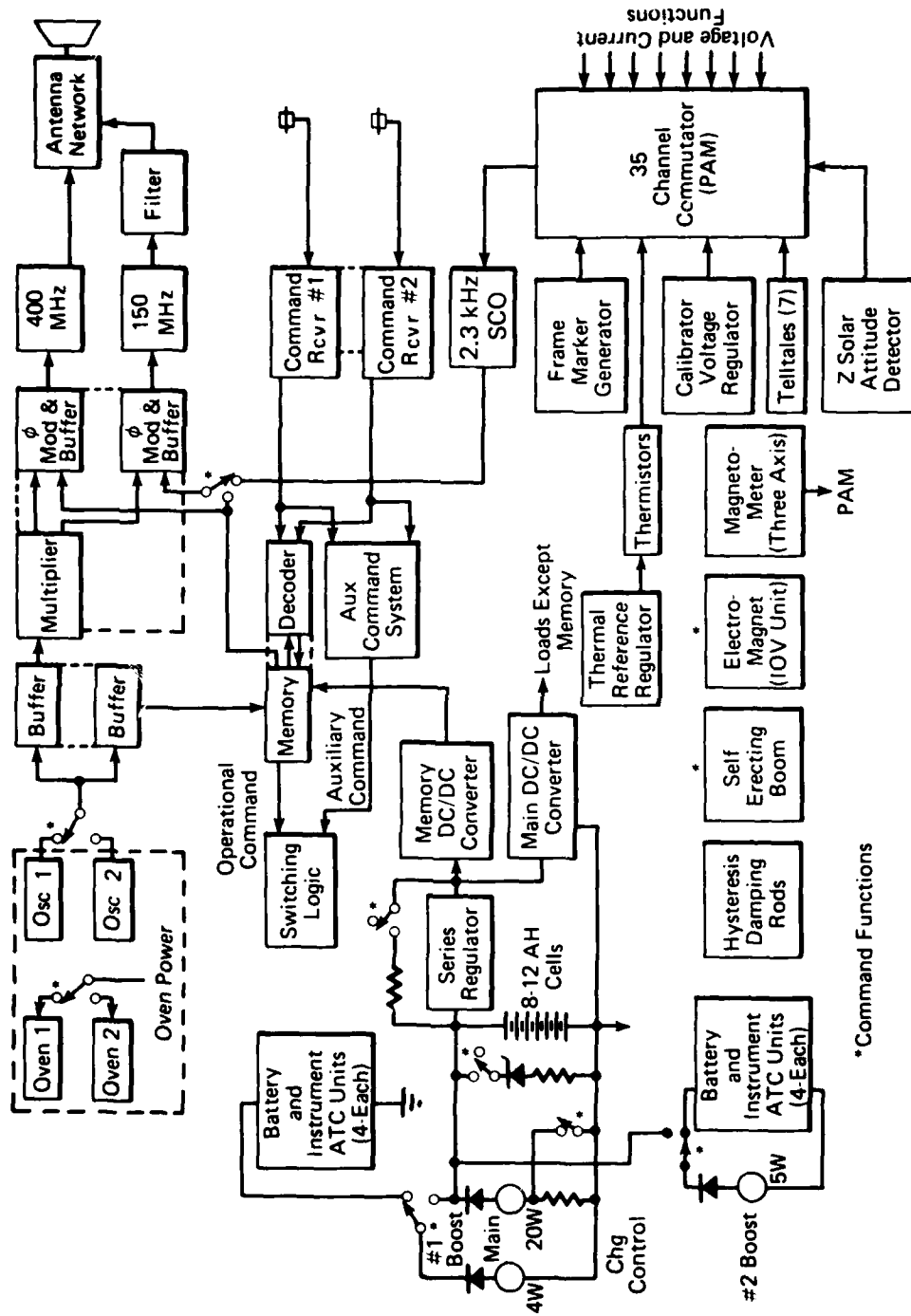

Fig. I-28 NNS (Oscar 15) Simplified Functional Block Diagram

Table I-2  
Oscar Satellite Features

<p style="text-align: center;"><u>Transmitting System</u></p> <p>Dual 5 MHz temperature-controlled quartz crystal oscillators plus phase modulators and power amplifiers radiating 400 MHz at 1.25 watts and 150 MHz at 0.1 watt via "lampshade" directional antenna aligned along satellite boom (Z) axis. Oscillator offset = 80 ppm. Transmitter output phase modulated with navigation message stored in satellite memory or (150 MHz only) with telemetry data selected on command or for two minutes automatically after a new message is injected into the memory.</p>
<p style="text-align: center;"><u>Memory</u></p> <p>24,960 bit core-storage memory stores navigation message injected by ground station twice-daily and reads out message at 50 bps. Capacity of memory provides for maximum of 16 hours of readout.</p>
<p style="text-align: center;"><u>Attitude Control and Detection System</u></p> <p>Yo-yo mechanical despun system plus magnetic hysteresis rods on solar panel spars for residual spin removal.</p> <p>Electromagnet for orienting satellite in earth's magnetic field prior to deployment of gravity gradient boom.</p> <p>22.86 m self-erecting gravity gradient boom along Z axis with 1.36 kg weight at end.</p> <p>Magnetometer and solar attitude detectors for determining satellite orientation with respect to the earth's magnetic field and the sun.</p>
<p style="text-align: center;"><u>Power Supply</u></p> <p>Solar cell/battery system with main and memory DC/DC converters. Cells are on both sides of four panels.</p>
<p style="text-align: center;"><u>Command System</u></p> <p>Dual receiver with main and auxiliary command logic and power switching and dual dipole antennas. System has capacity for 8 main and 8 auxiliary commands.</p>
<p style="text-align: center;"><u>Telemetry System</u></p> <p>35 channel real-time commutator with one channel subcommutated with seven telltales. Telemetry is read out as phase modulation on 150 MHz channel either on command or automatically for two minutes after each memory injection.</p>
<p style="text-align: center;"><u>Thermal Control System</u></p> <p>8 Automatic temperature control units maintain battery and instruments at 21.1°C. Passive system of Kropschott layers and aluminized Mylar used on satellite body.</p>
<p style="text-align: center;"><u>Structure</u></p> <p>Octagonal prism 45.72 cm across by 25.4 cm high. Transmitting antenna is compressed between satellite launch-vehicle adapter and satellite when satellite is on launch vehicle and extends when satellite is separated from vehicle. Adapter remains with launch vehicle at separation.</p>
<p style="text-align: center;"><u>Size and Weight</u></p> <p>Launch Configuration: 2.93 m high by 48.26 cm wide Gravity Gradient Configuration: 4.05 m wide by 26.67 m high Weight: ≈58.97 kg, including 8.17 kg adapter, which remains with launch rocket.</p>

Table I-3  
 Oscar Satellite RMS Oscillator Stabilities\*

Satellite	Oscillator No. 1	Oscillator No. 2
0-4	5 parts in $10^{11}$	4 parts in $10^{11}$
0-6	4 parts in $10^{11}$	4 parts in $10^{11}$
0-8	3 parts in $10^{11}$	4 parts in $10^{11}$
0-9	5 parts in $10^{11}$	2 parts in $10^{11}$
0-10	2 parts in $10^{10}$	2 parts in $10^{10}$
0-11	2.39 parts in $10^{11}$	2.58 parts in $10^{11}$
0-12	3.1 parts in $10^{11}$	3.5 parts in $10^{11}$
0-13	1.4 parts in $10^{11}$	1.7 parts in $10^{11}$
0-14	3.1 parts in $10^{11}$	1.8 parts in $10^{11}$

\*1.3 second averaging time.

### Objective

Serve as operational satellites of the Navy Navigation Satellite System.

### Achievements

The Oscar design objectives included developing a satellite that would be compatible with the inexpensive Scout launch vehicle, and that would have a mean time to failure of greater than one year. Presently, three of the operational satellites in the Navy's navigation satellite constellation that were fabricated at APL have been in continuous use for more than 10 years. Oscar satellites now have predicted life expectancies in excess of 13 years.

#### *Oscar 4*

Oscar 4 became a part of the Naval inventory of operational satellites as the launch objective was met. The gravity gradient stabilization boom was deployed 19 hours after launch on 25 June 1965. Stabilization was normal; maximum libration angles with respect to the local vertical were within  $\pm 10^\circ$  (this satellite did not employ a libration damping spring). Oscar 4 was in continuous use until 17 January 1966 when its usefulness was limited by low power supply voltage and thermal problems.

*Oscar 6:*

Oscar 6 was in the inventory of operational satellites until 16 May 1966. On 17 March, a break occurred in a solar cell blade circuit that caused a drop in the power output of the solar array. Operation with normal electrical loads thereafter tended to depress battery voltages during times of minimum sunlight. To prevent excessive battery discharge, satellite transmitters were maintained silent between 16 May and 23 June except for short intervals in which telemetry data were obtained and during one short operational trial period. By 23 June, the satellite orbit was in high percent sunlight and transmitters were commanded on again for continuous operation. Oscar 6 was returned to navigation service on 28 June and used satisfactorily until 5 August 1966 when the percent sunlight decreased and it was removed from operational status.

*Oscar 8:*

Oscar 8 was in the inventory of navigation satellites from 31 March 1966 to 25 February 1967. Solar array degradation then caused battery voltages to become depressed below required levels, thus forcing the satellite out of operational service.

*Oscar 9:*

Oscar 9 was in the inventory of operational navigation satellites from 16 June 1966 to 1 March 1967. Navigational service ceased after solar array degradation caused battery voltages to become depressed below required levels.

*Oscar 10:*

Oscar 10 was in the inventory of operational navigation satellites from 27 August 1966 to 8 June 1967. A solar array degradation condition gradually developed which depressed battery voltages when minimum percent sunlight conditions existed. To prevent excessive battery discharge, transmitters were maintained silent between 8 June and 5 July 1967 except for periodic telemetry checks. On 5 July, the satellite was returned to continuous operational service because percent sunlight conditions increased sufficiently to support sustained operation with the degraded solar array. The satellite was in use until 11 August 1967 when the percent sunlight decreased and it was removed from operational status. The satellite is maintained silent.

*Oscar 12 - Oscar 14:*

Oscars 12, 13, and 14 have been in the inventory of operational navigation satellites since 19 April 1967, 24 May 1967, and 5 October 1967, respectively. The launch objectives have been met.

TRIAD SATELLITE  
(1972 69A)



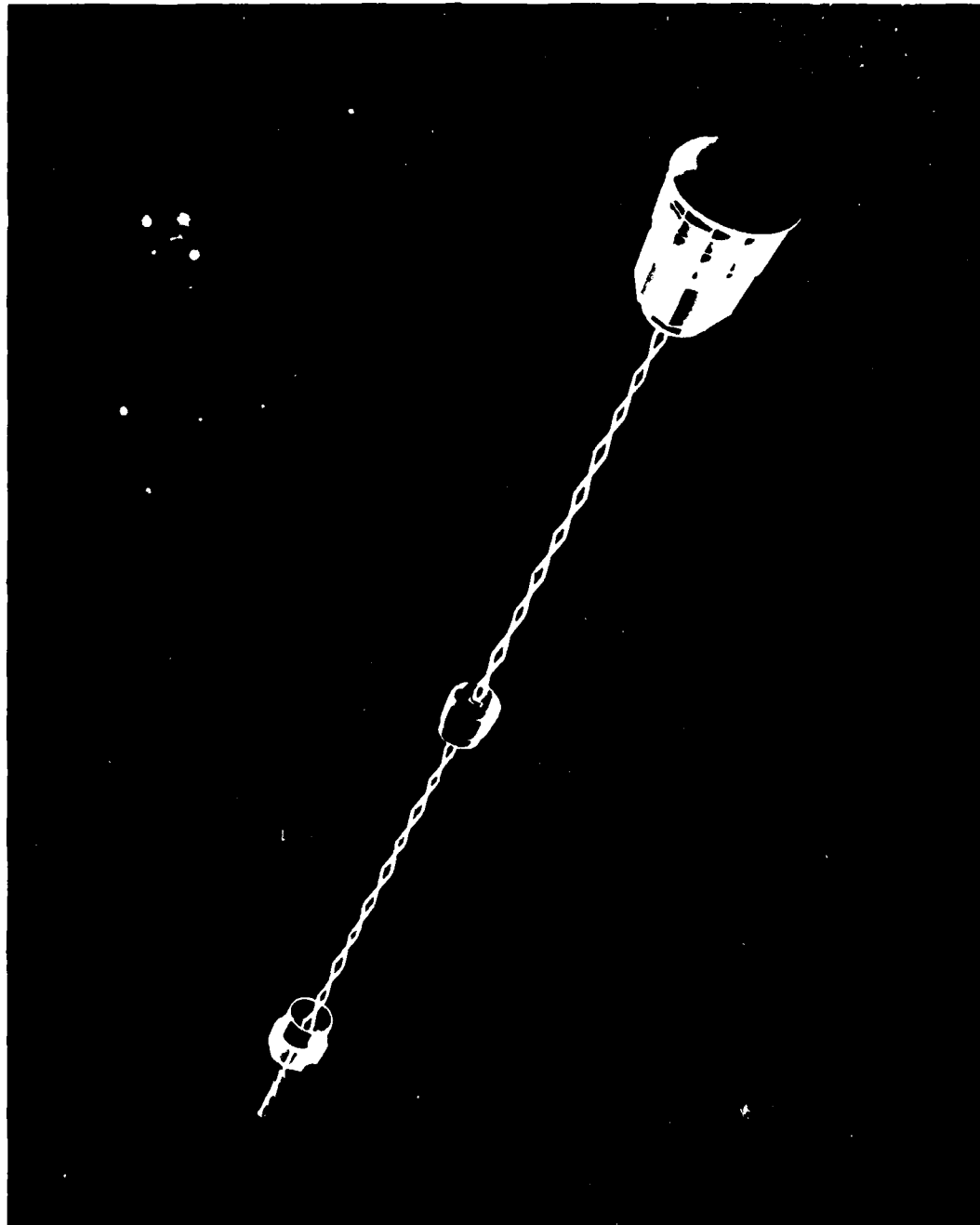

Fig. I-29 TRIAD Satellite, Artist's Concept

TRIAD SATELLITE

Launch: 2 September 1972, Vandenberg AFB, California  
Vehicle: Scout (four stage)  
Orbit: Apogee 809.7 km, perigee 728.2 km, inclination 90.1°  
Remarks: Average satellite altitude about 92.65 km below nominal; all other orbital parameters close to nominal. Satellite-vehicle adapter separation, despin, and antenna deployment normal.

Background

The three-bodied TRIAD satellite was the first in a series of three experimental/operational spacecraft designed to flight test improvements to the Navy Navigation Satellite System. These improvements included a disturbance compensation system (DISCOS), a pseudo-random noise (PRN) experiment, an incremental phase shifter (IPS), and a programmable computer.

Physical Characteristics (Fig. I-29)

Overall Size (Launch): 1.68 m long by 0.76 m wide

(Orbit): 7.47 m long

Power: 30-watt radioisotope thermoelectric generator with auxiliary power system of four solar cell panels and one 6 Ah Ni-Cd battery.

Weight: 93.9 kg.

Features

A simplified system block diagram of the TRIAD satellite is shown in Fig. I-30; the main satellite features are summarized in Table I-5. In addition, a magnetometer experiment was carried on-board TRIAD as were experiments to test an environmental survey panel of solar cells and covers, and thermal control coatings of high purity silica fiber cloth and silica aluminum fiber cloth.

DISCOS, designed at Stanford University under subcontract to APL/JHU, consisted of controller, proof mass, housing and caging structure, electronics, and propulsion subsystems (Fig. I-31). The unsupported proof mass was shielded by the satellite from external forces. Since only gravitational forces acted on the mass, it followed a purely gravitational orbit. The DISCOS control system

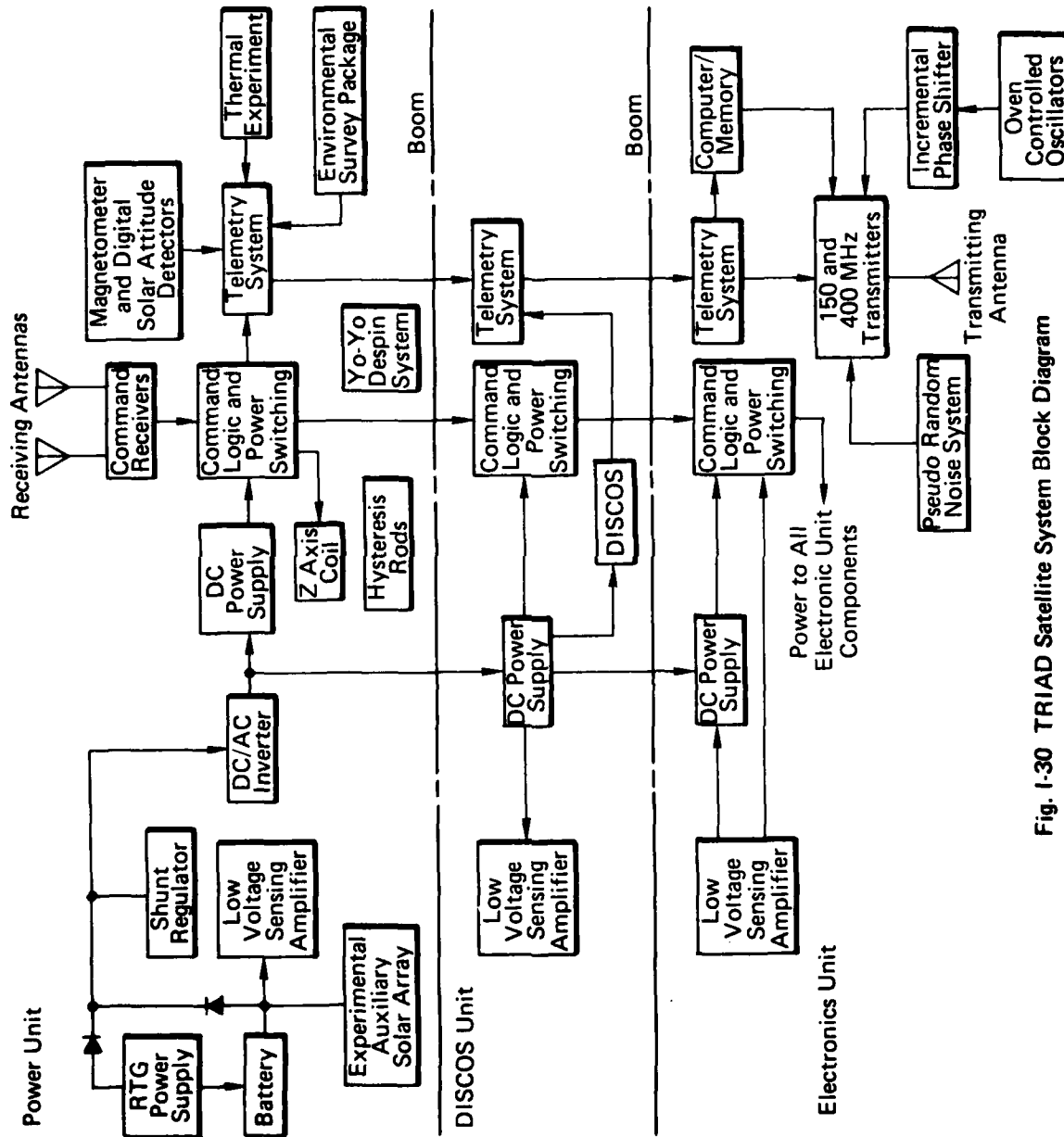

Fig. I-30 TRIAD Satellite System Block Diagram

Table I-4  
TRIAD Satellite Features

Station Keeping System	
Three-axis disturbance compensation system (DISCOS), consisting of a proof mass in a housing with a system of capacitive plate displacement sensors and six pneumatic propulsion thrusters. Thrusters maintain satellite centered on proof mass. Propellant used in thruster subsystem is Freon 14 at a pressure of 210.93 kg/cm.	
Transmitting System	
Dual 5 MHz temperature-controlled quartz crystal oscillators, plus phase modulators and power amplifiers radiating 400 MHz at 6 watts and 150 MHz at 3 watts via quadri-filar helical directional antenna. Oscillator offset controlled by incremental phase shifter (IPS) and selectable at -84.48 ppm (operational) and -145.51 ppm (maintenance). Long term oscillator drift correctable by IPS, with correction updated through satellite computer. Phase modulation on 150 MHz/400 MHz signals selectable and may be navigation message or telemetry data. Pseudorandom noise (PRN) pattern may also be superimposed on the 150 MHz/400 MHz carriers for ranging navigation.	
Computer/Memory System	
Ground-programmable system serving as a real-time controller operating under priority interrupt with the following assignments: store satellite navigation messages and delayed commands, read out navigation message at 50 bps and direct command execution, monitor and store telemetry data, monitor and store data on the operation of the DISCOS and its propulsion subsystem, and process data for IPS and PRN. Memory Capacity = 64,000 bits.	
Attitude Control and Detection System	
Yo-yo mechanical despin system plus magnetic hysteresis rods for residual spin removal.	
Electromagnet for orienting satellite in earth's magnetic field prior to deployment of gravity gradient boom.	
Two 3.1 m motor driven colinear, scissors type booms between power, DISCOS, and electronics units. The booms place DISCOS at the center of mass of the satellite, locate the other two units far enough away from DISCOS to avoid mass attraction effects, and orient the transmitting antenna on the electronics unit always pointing earthward.	
Momentum wheel to maintain three axis stabilization.	
Magnetometer and solar attitude detectors for determining satellite orientation with respect to earth's magnetic field and the sun.	
Power Supply	
AEC supplied radioisotope thermoelectric generator (RTG) plus solar cell/battery auxiliary system.	
Command System	
Dual tuned radio frequency (TRF) receiver plus redundant command logic and power switching providing 70 commands. System also responds to delayed commands stored in satellite computer.	
Telemetry System	
Capacity for 70 channels of 24 bits per channel, with 8 bits obtained from each of the power, DISCOS, and electronic units. Data may be read out directly or stored in the satellite memory.	
Thermal Control System	
Passive system consisting of external coatings and internal insulation of aluminized Teflon and Mylar.	
Structure	
Power Unit: RTG is 12 sided prism mounted on octagonal body containing power processing instrumentation.	
DISCOS Unit: Cylinder retracted within electronics unit in launch configuration.	
Electronics Unit: Octagonal body with cutout for stowing transmitting antenna in launch position.	
Size and Weight	
Launch Configuration:	1.68 m long by 0.76 m wide
Gravity Gradient Stabilized Configuration:	7.47 m long by 0.76 m wide
Weight:	93.9 kg

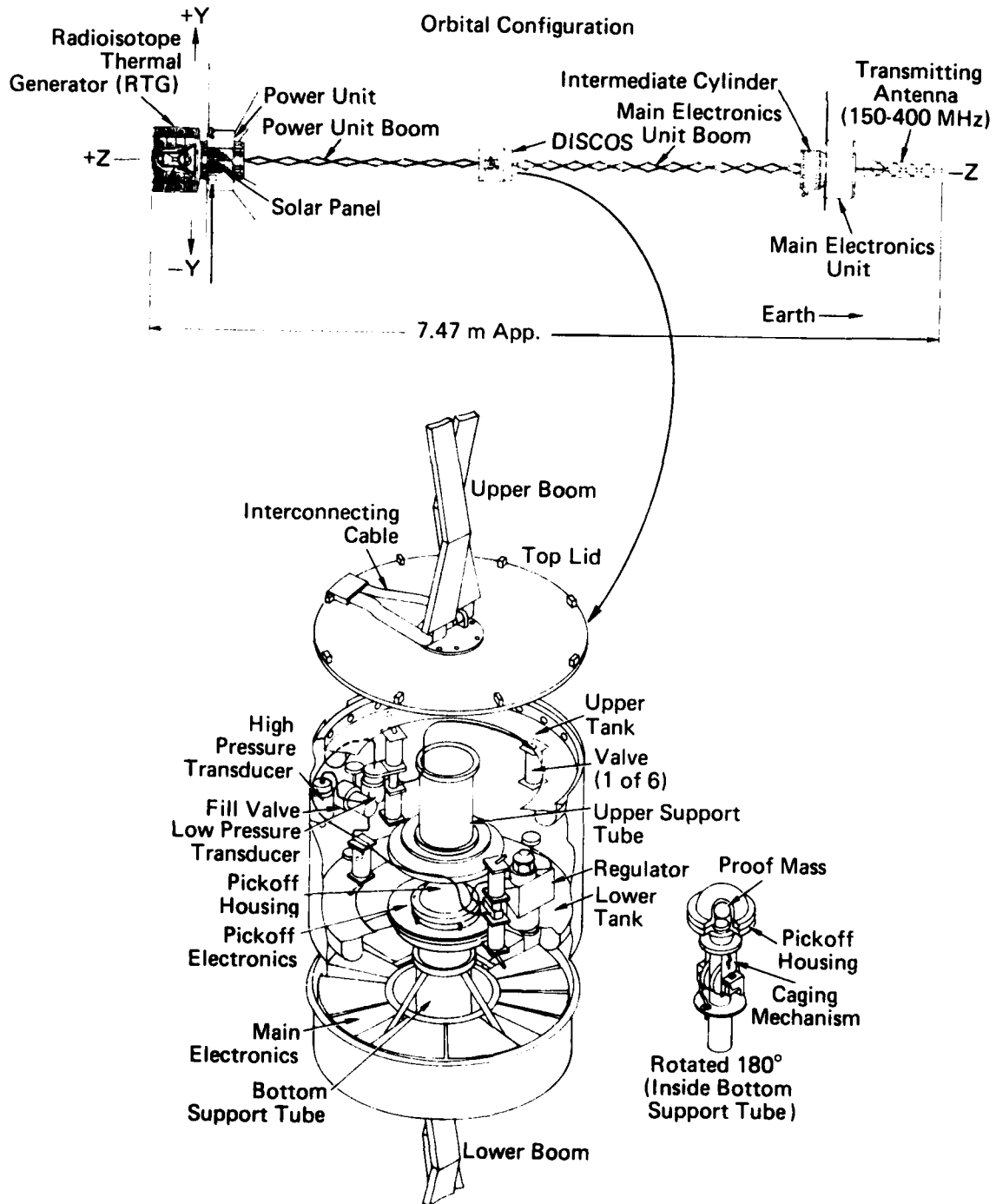

Fig. I-31 DISCOS, Cutaway View

sensed the motion of the satellite relative to the mass and activated thrusters which forced the satellite to follow the mass without touching it. The satellite therefore followed a purely gravitational orbit free from the effects of external surface forces such as solar radiation and atmospheric drag.

TRIAD was stabilized in three axes because orientation of the DISCOS thrusters fore and aft along the flight path provided maximum efficiency in the use of thruster propellant, and accurate drag and solar pressure data could be better interpreted. Overall satellite system benefits derived from three-axis stabilization were refinement in the transmitting antenna pattern and better predictability of satellite thermal conditions. Satellite attitude control was accomplished by the three-bodied "dumbbell" configuration which stabilized the satellite in pitch and roll by virtue of its elongated configuration. This provided the gravity gradient stabilizing torque necessary to align the Z axis with the vertical. The Fig. I-31 orbital configuration shows the satellite orbit coordinates and relates the attitude detectors to the referenced control axes. Control of the X and Y axes was obtained principally by use of a momentum wheel whose spin axis was perpendicular to the Z axis of the satellite. Satellite oscillations were damped with magnetic hysteresis rods that interacted with the earth's magnetic field.

To establish in-orbit capture, a yo-yo despin system was used to decelerate the spin rate to a few rpm. Magnetic hysteresis rods removed residual spin and later provided librational motion damping. Current was passed through a Z axis magnet coil to achieve magnetic stabilization, a necessary prerequisite to right-side-up gravity gradient stabilization.

After acceptable magnetic stabilization had been achieved, attitude stabilization was analyzed in real time to determine the optimum moment to achieve gravity capture. This was done by deploying the booms upon ground command, and turning off the Z magnetic coil. Also by ground command, the momentum wheel could be operated in one of several modes to aid in maintaining three-axis stabilization. The momentum wheel, located in the main electronics unit to provide yaw stabilization, was used during the magnetic and gravity gradient stabilizing maneuvers and after gravity gradient capture.

#### Objectives

1. Correct long term drift in the satellite oscillator with the IPS, updating the correction automatically through the satellite computer and improving satellite timing to the nanosecond range.
2. Reduce the data gathering time required for a navigation fix through the use of PRN range data.

3. Demonstrate the capability of DISCOS in causing the satellite to follow a purely gravitational orbit free from the effects of external surface forces.
4. Obtain data on RTG performance trends as a function of lifetime in orbit.
5. Obtain data on the orbital effects on the environmental survey panel.
6. Obtain data on changes in the optical properties of the thermal control coating experiment.
7. Serve as an operational satellite of the Navy Navigation Satellite System.

#### Achievements

All TRIAD satellite and space technology experiments were exercised, and the TRIAD short term objectives were demonstrated. A failure that occurred in the 8-bit analog-to-digital telemetry converter on 2 October, and in the computer on 2 November 1972, resulted in satellite activities being directed toward completion of the usable satellite experiments.

During post-launch operations on 13 September 1972, commands were sent to uncage the proof mass and activate the thruster jets. Telemetered data on proof mass position, resolved into axial components, showed that five minutes after command the proof mass became located within a  $\pm 1$  mm dead band position at the center of the housing cavity. The results of further tests indicated that the closed loop control system on proof mass position was operating as designed.

DISCOS operated successfully until propellant exhaustion on 18 April 1975, exceeding substantially its one-year design life. Experiments with an orbital prediction span of up to two months showed that drag and radiation forces were eliminated, and that the DISCOS self-bias force was less than  $10^{-11}g$ . By virtue of the long-term predictable orbits made possible by DISCOS, it was shown that the requirement for updating the predicted orbits of the Navy Navigation Satellites every 12 hours could be eliminated and user navigation equipment simplified.

The PRN experiment was designed to explore possible improvements in satellite navigation through the use of highly precise timing signals. As applied to the NNSS, the timing signals would be obtained in the navigation receivers by the recovery of a precision time-signal modulation imposed on the satellite 150/400 MHz carriers. The results of experiments with TRIAD indicated that (1) a reduction

in navigation data span was possible for certain satellite navigation receivers without serious degradation in accuracy, (2) dual-frequency PRN-ranging navigation gave nearly the same navigation accuracy as dual frequency integral doppler navigation when the full-pass data span was used, (3) single frequency (400 MHz) doppler and ranging fixes were essentially equivalent to dual frequency (150/400 MHz) integral doppler fixes in eliminating the large first-order effect on ionospheric refraction, and (4) by means of PRN modulation, satellite timing signals could be transmitted with nanosecond precision.

During post-launch operations, the IPS was exercised and performed the precise frequency translations commanded by the computer. The epoch setting process was fully confirmed and refined time adjustments were being made when the computer malfunction occurred.

The attitude detection system included a three-axis fluxgate vector magnetometer and solar attitude detectors that produced both analog and digital data outputs. These data were intended primarily for use in analyzing the performance of the attitude control system, and also in DISCOS data analysis. However, these high-resolution (both in time and amplitude) magnetometer data are also useful in studying currents along the earth's magnetic field, and are presently being acquired by the Canadian Department of Energy, Mines and Resources at Resolute Bay, Canada, and the University of Texas at McMurdo, Antarctica. The data are presently being used at APL/JHU in various studies related to magnetospheric and auroral physics.



TIP-II AND -III SATELLITES

TIP-II  
(1975 99A)

TIP-III  
(1976 89A)

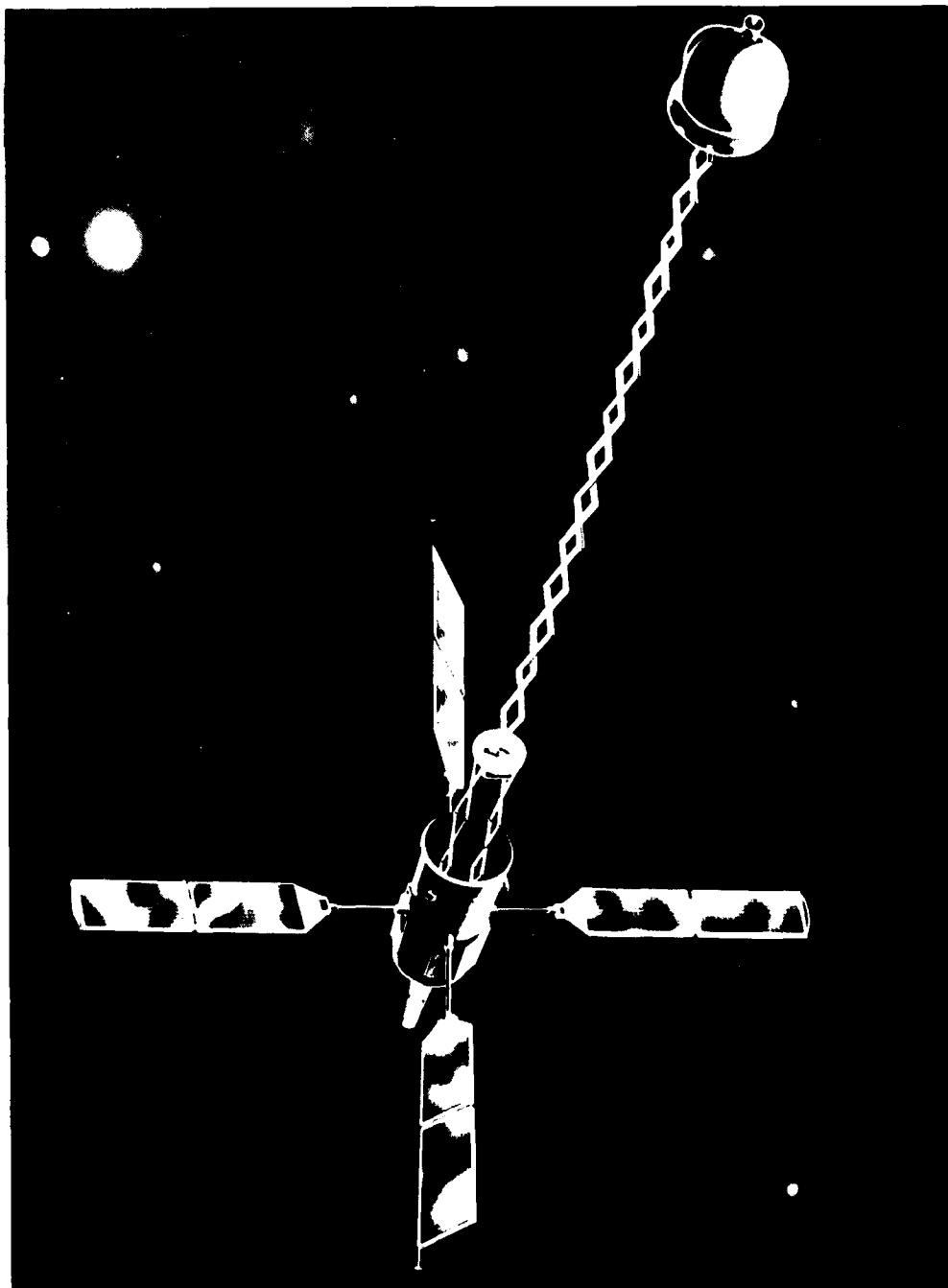

Fig. I-32 TIP Satellite, Artist's Concept

TIP-II AND -III SATELLITES

Launch: (TIP-II) 12 October 1975; Vandenberg AFB  
(TIP-III) 1 September 1976; Vandenberg AFB

Vehicle: Scout (four stage)

Orbit: (TIP-II) Apogee 830.2 km, perigee 530 km,  
inclination 90.38°  
(TIP-III) Apogee 867.2 km, perigee 452.1 km,  
inclination 89.29°

Remarks: The solar panels of both satellites failed to  
deploy, thus severely limiting the power available  
for spacecraft operation.

Background

The TIP-II and -III satellites (Fig. I-32), developed as part of the Transit Improvement Program (TIP) at APL, were prototypes of a new series of navigation satellites to replace the Oscar (or Transit) satellites of the Navy Navigation Satellite System. The APL TRIAD satellite, considered the first TIP satellite, employed a three-axis disturbance compensation system (DISCOS). A simplified, single-axis DISCOS was used on TIP-II and -III to achieve a drag-free satellite. Spacecraft thus equipped are capable of maintaining their projected orbital ephemeris with an accuracy of +85 meters for a minimum 7-day period, thus negating the Oscar satellite requirement for an ephemeris update at 12-hour intervals.

Physical Characteristics

Body: Octagonal body 52.07 cm across and 39.37 cm high topped by cylindrical attitude section 26.67 cm in diameter and 76.2 cm high.

Appendages: Extendable dual scissors boom 60.96 cm long for locating DISCOS at center of satellite mass, a colinear 701.04 cm extendable scissors boom with attached OATS (orbit adjust transfer system), four solar panels, and a 150/400 MHz quadrifilar helix antenna on aft end of main satellite body.

Weight: 160 kg, including 7.26 kg adapter which remains with 4th stage when satellite is injected into orbit.

## Features

A simplified system block diagram of the TIP-II/-III satellite is shown in Fig. I-33; the main satellite features are summarized in Table I-4.

Although the three-axis DISCOS used on the TRIAD satellite (preceding article, Fig. I-31) produced an exceptionally accurate orbit, the gravitational force between the proof mass and satellite components was such that the spacecraft fabrication and assembly procedures required detailed bookkeeping of the mass and position of each component to compensate for mass attraction. The TIP single-axis DISCOS was devised to achieve a drag-free satellite in a simpler fashion. Here, the proof mass (Fig. I-34) is suspended electromagnetically and is free to move in the flight path direction, but transverse motion is constrained. The position of the proof mass is detected optically, and a plasma jet thruster is fired to make the satellite follow the proof mass. Since the proof mass is shielded from aerodynamic drag and solar radiation pressures it responds to gravity forces only; it is therefore in a drag-free trajectory, and so also, the satellite.

The proof mass is a cylindrical shell, 3.15 cm long x 1.70 cm OD x 1.04 cm ID, made of pure aluminum with low magnetic susceptibility and ion-deposited with 20,000 Å of gold to distribute evenly electrostatic potential. A caging system protects the mass during launch, and releases it during gravity gradient boom deployment. The levitation force is provided by a 2.08 kHz square wave current passing through the axis and generating eddy current propulsion forces in the proof mass. The suspension current is returned through evenly spaced radial conductors in the end caps and resistive wires parallel to the axis, thus preventing imaging effects from biasing the proof mass.

Two optical systems are used to detect proof mass position: An axial system determines along track position, and a transverse system detects radial offset about the axis. The axial optical system uses parabolic mirrors to collimate light from a 100,000 hour life tungsten bulb, pass the light across the ends of the proof mass, and refocus it on a set of photocells. The difference in current produced between the two photocells is a linear measure of proof-mass position along the axis. Both coarse-range (+10 mm) and fine-range (+2 mm) proof-mass positions are telemetered to ground receivers, providing position resolution of 0.08 and 0.015 mm, respectively. The data are used in aeronomy studies and to provide in-orbit thruster calibration. The transverse system uses the light from the axial system bulbs. Spherical mirrors at the axis ends collimate the bulb light, pass it through the proof-mass center,

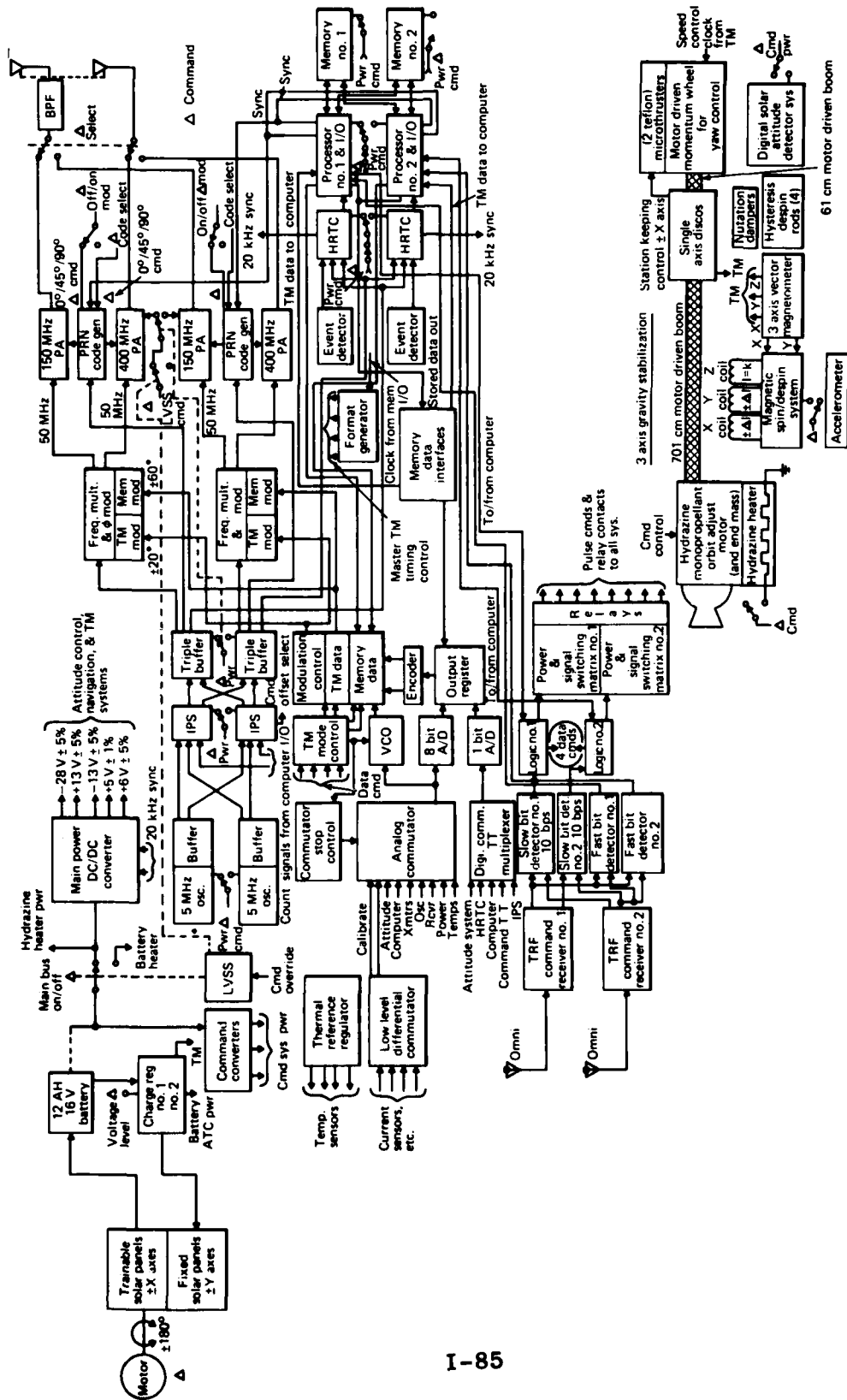

Fig. I-33 TIP Satellite System Block Diagram

Table I-5  
TIP Satellite Features

<p style="text-align: center;"><u>Station Seeking System</u></p> <p>Orbit Adjust and Transfer System (OATS), consisting of 7.3 kg, 43.2 cm O/spherical tank with feed and nozzle system, and containing 27.2 kg of pressure-fed liquid hydrazine propellant to provide about 5,897 kg-sec of total impulse thrust. Gaseous nitrogen used as pressure source.</p>
<p style="text-align: center;"><u>Station Keeping System</u></p> <p>Single-axis disturbance compensation system (DISCOS) consisting of shielded container enclosing cylindrical shell proof mass frictionlessly suspended along satellite flight axis by eddy current repulsion. Motion of shielded container about proof mass sensed by optical system, which controls operation of Teflon Solid Propellant Propulsion System (TSPPS) to counteract drag forces acting on satellite. TSPPS ionizes solid Teflon to plasma to produce thrust, with ionizing energy stored in high voltage Mylar capacitors containing a liquid monoisopropyl biphenyl dielectric.</p>
<p style="text-align: center;"><u>Transmitting System</u></p> <p>Dual 5 MHz temp.-controlled crystal oscillators plus redundant phase modulators and power amplifiers radiating 400 MHz at 6.0W and 150 MHz at 3W via quadrafilar helical antenna. Oscillator offset controlled by incremental phase shifter (IPS) and selectable at -84.48 ppm (operational) and -145.51 ppm (maintenance). Long term oscillator drift corrected by IPS, with correction updated through satellite computer. Phase modulation on both signals selectable and may be navigation message, compact ephemeris navigation message, pseudorandom noise (PRN) pattern at modulation levels of 0°, 45°, or 90° for ranging navigation, or TM data.</p>
<p style="text-align: center;"><u>Computer/Memory System</u></p> <p>Redundant ground-programmable system. Computer serves as real-time controller operating under priority interrupt system to: store satellite navigation messages and delayed commands, read out navigation message at 50 bps and compressed navigation message at 25 bps, execute delayed commands, monitor and store TM, DISCOS, and TSPPS data, and process IPS and PRN data. Capacity of each memory = 262,144 bits (5 day navigation message capacity); combined capacity of both memories allows 10 day navigation message. Memory may be dumped on command at 1302 bps.</p>
<p style="text-align: center;"><u>Attitude Control and Detection System</u></p> <p>Yo-yo mechanical despin system plus magnetic hysteresis rods on solar panel spars for residual spin removal.</p> <p>Magnetic spin-despin system to orient and stabilize satellite during station seeking maneuvers plus nutation dampers on ends of +Y solar blades and accelerometer for evaluating OATS performance.</p> <p>Electromagnet for orienting satellite in earth's magnetic field prior to deployment of gravity gradient boom.</p> <p>Motor driven 61 cm dual scissors boom along +Z axis for locating DISCOS proof mass at satellite cg plus colinear 701 cm scissors boom for gravity gradient stabilization (empty OATS tank serves as boom end mass).</p> <p>Momentum wheel to capture and anchor satellite in yaw during magnetic and gravity gradient stabilization.</p> <p>Magnetometer and solar attitude detectors for determining satellite orientation.</p>
<p style="text-align: center;"><u>Power Supply</u></p> <p>Solar cell/battery system with battery charge regulator. Inplane solar panels (+X) rotatable a total of +180° on command to regulate power generating capability; non-rotatable across plane panels (+Y) are flat to orbit path.</p>
<p style="text-align: center;"><u>Command System</u></p> <p>Redundant receivers, 10 bps (command) and 1000 bps (memory load) bit detectors, command logic, power switching, low voltage sensing switches, and antennas. System has a capacity for 64 real-time signal and power relay commands, plus memory load and data commands.</p>
<p style="text-align: center;"><u>Telemetry System</u></p> <p>Capacity for 172 channels of 8 bit digital words read out at 325 bps directly or stored in satellite memory, plus backup analog readout obtained on command via a VCO.</p>
<p style="text-align: center;"><u>Thermal Control System</u></p> <p>Active heater system used on battery and on OATS fuel tank and feed line.</p> <p>Passive system of aluminized layered Kapton blanket secured with Velcro zipper used on OATS to shield hydrazine in tank from high nozzle temperatures, multilayered insulation used on attitude cylinder, and thermal shield of aluminized Teflon and Mylar used on main body.</p>

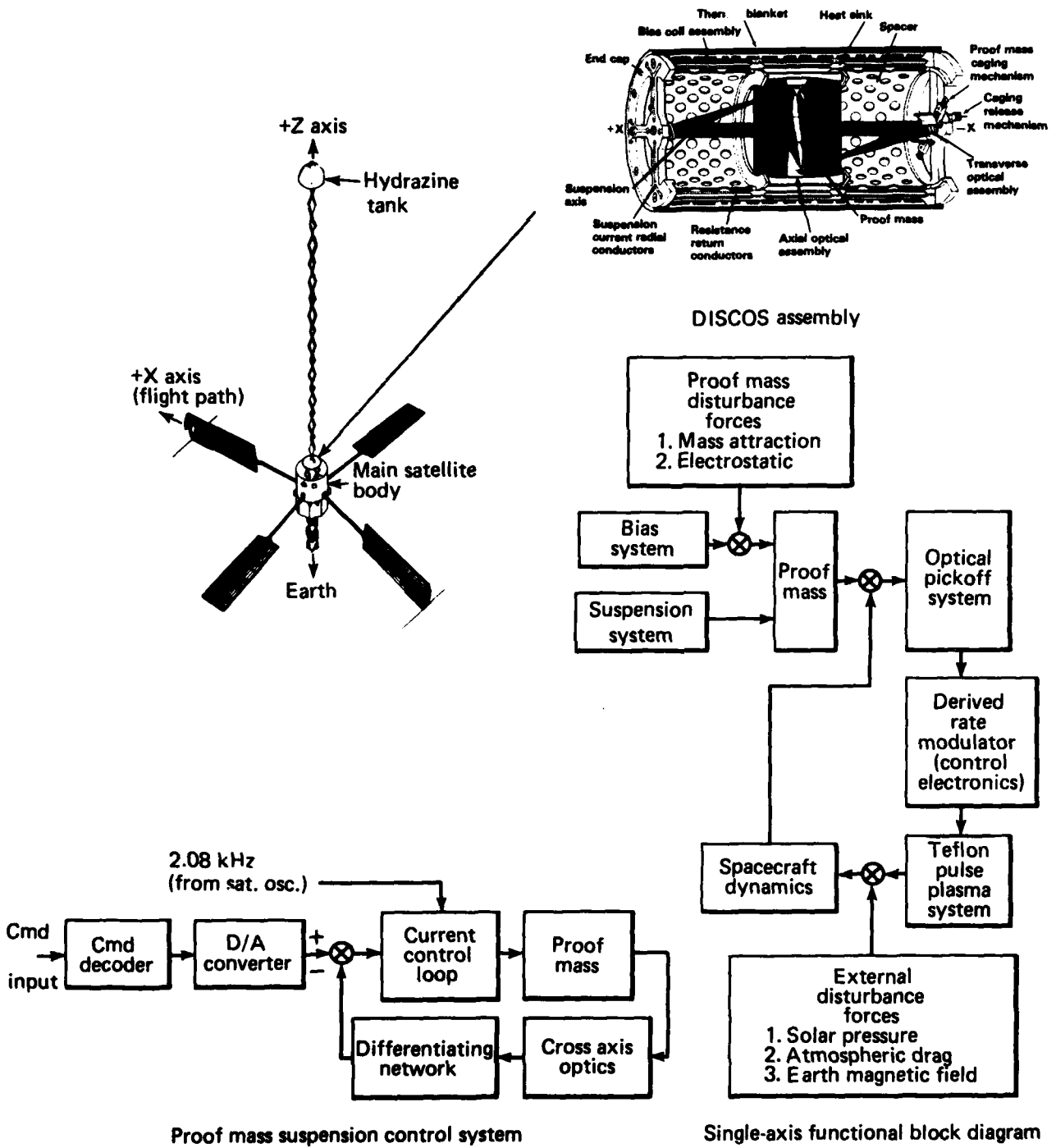

Fig. I-34 Single-Axis DISCOS

and refocus it on a photocell. This signal, a measure of radial position of the proof mass, is differentiated to determine radial velocity. The result is used to modulate the suspension current, providing active damping of proof-mass dynamics.

The biasing system balances any axial components of proof-mass disturbance forces. The system consists of two opposing coils, each configured to provide a constant force over a proof-mass range of  $\pm 10$  mm. Over the normal operating range of  $\pm 2.25$  mm, a variation of less than 0.05% exists in the biasing force. A 1.04 kHz sine-wave current passing through the selected coil produces eddy current repulsion of the proof mass. Coil current is commandable to a maximum of  $10^{-8}$  g, in  $10^{-11}$ -g increments, providing in-orbit tailoring of the proof-mass velocity.

### Objective

Enhance the US Navy worldwide satellite navigation capability through improved hardware and new features.

### Achievements

All launch vehicle and spacecraft systems functioned as expected during the TIP-II/-III satellite launch phases. In both cases, however, tracking stations later reported that the solar panels had not fully deployed. With onboard power thus severely curtailed, spacecraft activities were restricted to checking out the satellite systems to verify proper operation. There was a second problem with TIP-II when the boom did not extend to its operational length due to an overstressed condition, and gravity-gradient capture did not occur. While this happened after the TIP-III launch, and while the boom mechanisms of both satellites were similar, the TIP-III satellite was successfully stabilized by using centrifugal force obtained by tumbling the spacecraft to extend the boom.

Studies to determine the failure mechanism of the TIP-II solar array deployment mechanism were limited since the failure had occurred while the spacecraft was out of view of a data collection site, and little real-time and computer-stored data were available. While many failure hypothesis were proposed, none could be substantiated. Major changes incorporated in the TIP-III satellite as a result of the TIP-II solar panel anomaly included (a) improved timing regulation in the despun-separation timer, (b) increased margin in the solar panel deployment system through the use of low friction bearings, increased force in the deployment spring, and panel deployment at a satellite spin rate of 20 rpm to allow centrifugal force to assist the spring force, and (c) increased margin in the  $\pm X$  panel rotation drive linkage to double the drive force.



Provisions were also made for the spacecraft computer to store a wider spectrum of selected channels of telemetry during the first orbital revolution. With these additional data, the study group that was formed to determine the cause of the TIP solar arrays to deploy were able to isolate and convincingly demonstrate the failure mechanism. It was shown that aerodynamic heating at heatshield ejection caused the command antennas to bond to their nylon guides. The antennas are mounted at the ends of opposite solar panels and the guides, located on adjacent panels, are used to restrain antenna motion during launch. Group findings are contained in the following:

- TIP Study Group Report, APL/JHU SDO 4787, August 1977.
- Vol. I - Summary.
- Vol. II - Solar Array Deployment Failure Analyses.
- Vol. III - Gravity-Gradient Boom Failure Analyses.

Although restricted by minimum solar array power for battery charging, and with TIP-II randomly oriented, subsequent TIP-II/-III activities have indicated satisfactory performance of the spacecraft electronic subsystems. Accordingly, with the areas requiring redesign clearly defined, a contract for conversion from development to production TIP spacecraft was let by the Navy to an industrial contractor. Delivery of the first production TIP satellite, called NOVA, is scheduled for late 1979.

TRANSLATOR SATELLITE (TRANSAT)

(1977 106A)

I-91

REPRODUCING PAGE BLANK-NOT FILMED

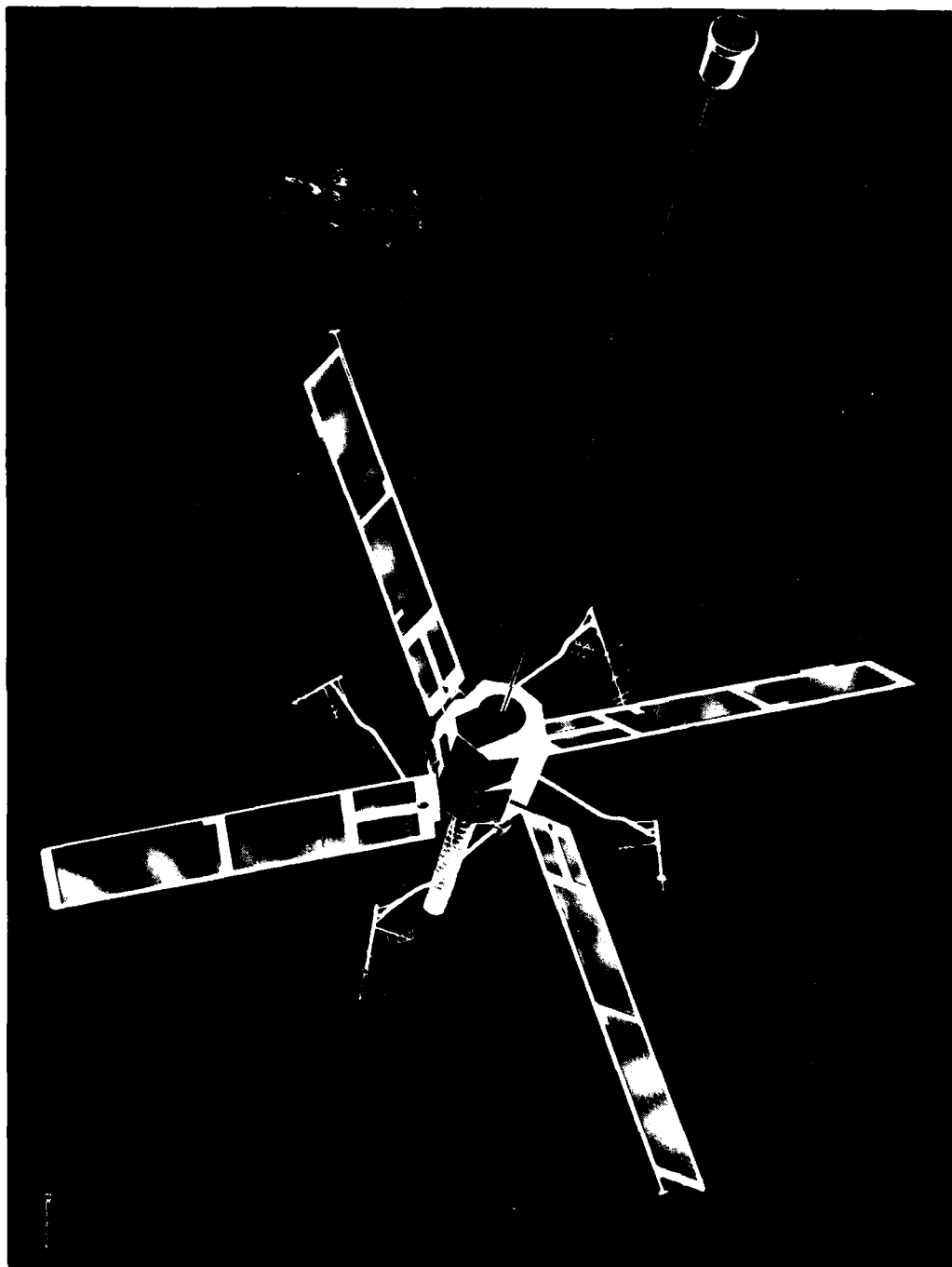

Fig. I-35 TRANSAT, Artist's Concept

### TRANSLATOR SATELLITE (TRANSAT)

Launch: 28 October 1977: Vandenberg AFB, California

Vehicle: Scout-D (four stage, solid fuel)

Orbit: Apogee 1108 km, perigee 1069 km, inclination 89.9°

Remarks: Despin, solar panel deployment, 4th stage separation, and stabilization normal; orbit achieved was essentially as desired.

#### Background

TRANSAT is an off-the-shelf Transit satellite (O-11) that was modified by APL to carry dual translators. Originally fabricated at APL in early 1966, O-11 had been in standby storage at APL as a replacement for possible use in the satellite constellation of the Navy Navigation Satellite System. The modified satellite retains its navigation capabilities and, thus, has two operational modes: the Transit navigation mode and the SATRACK (satellite tracking)/Range Safety, or translator mode. SATRACK, developed at APL in response to a Navy requirement for the full evaluation of the accuracy of present and future FBM systems, provides an independent measurement system for the direct determination of missile trajectory by combining missile telemetry data with measurement data from Global Positioning System (GPS) satellites and estimates of guidance component performance and weapon system accuracy for the Navy Improved Accuracy Program (IAP). In the SATRACK mode TRANSAT receives, translates, and retransmits GPS satellite signals and other signals to simulate an orbiting test missile and thus permit the realistic evaluation of SATRACK Surface-Station Equipment (SSE) and the SATRACK Processing Facility (SPF) at APL. In the Range Safety mode, TRANSAT again simulates a translator equipped missile to permit checkout and evaluation of Range Safety system equipment. Range Safety involves a ground based signal transmission network in which the missile translated signals are tracked and processed to provide estimates of predicted impact position (PIP) for Range Safety operations.

#### Description

Basically, TRANSAT (Fig. I-35) is a Navy Navigation Satellite reconfigured to include a penthouse structure containing two redundant SATRACK translators and auxiliary power switching for the translator DC-DC converters. The satellite electronic components for navigation are housed in the octagonally-shaped main body to

which four solar blades are attached. Command receiving dipole antennas are mounted on the ends of the +Y and -Y solar blades, and a 150/400 MHz doppler and telemetry helix antenna is mounted on the base of the satellite. Antenna elements at the ends of four symmetrical booms provide antenna patterns that simulate the Trident/translator missile configuration. These include 394 and 1575 MHz receiving antennas and S-band (2274 MHz) downlink antennas. A 21.34-m boom that extends from the top of the satellite acts as a gravity-gradient stabilizer to keep the antennas pointed at the earth.

*Translator Mode Utilization:*

1. SATRACK Testing. In the translator mode TRANSAT may serve as a test vehicle to receive, translate, and retransmit the GPS satellite signals and other signals to simulate those of a Trident test missile. Figure I-36 shows a simplified SATRACK test configuration with only one GPS satellite. The GPS monitor stations track the GPS satellite L<sub>1</sub> (1575.42 MHz) and L<sub>2</sub> (1227.6 MHz) signals and send the tracking data to the Orbit Determination Facility (ODF) at the Naval Surface Weapons Center/Dahlgren, Va. (NSWC/DL). In addition to other data, high rate data tapes of TRANSAT tracking data are generated by the Flight Test Support System (FTSS) which is part of the SSE.

At the ODF, the data are combined with the appropriate subset of the GPS monitor data and used to generate a tracked ephemeris data tape. This tape is then provided to the SPF as a basic data source of GPS satellite position, velocity, and time and frequency errors for use in the postflight analysis of a TRANSAT pass or, for a missile launch, missile trajectory.

Several test configurations are possible. In that shown, surface located pseudosatellites (PSs) provide additional reference points. L<sub>1</sub> signals from the GPS satellites and the PSs are received by TRANSAT, shifted to S-band by the satellite translator, and transmitted to the SSE where they are recorded for later processing by the SPF. L<sub>1</sub>/4 (393.855 MHz) signals from the Local Ranging Station (LRS) received by TRANSAT are also translated to S-band and retransmitted to the SSE to provide TRANSAT tracking data. The LRS and PS transmissions are combined to provide ionospheric measurements.

At the SPF, basic SSE data (missile tracking, missile telemetry, ship tracking, and ionospheric propagation data) are processed along with GPS orbit data and missile initial conditions data to produce missile trajectory and guidance error estimates for the Navy IAP. Guidance derived quantities (from missile telemetry data) with corresponding SATRACK measured quantities (from missile tracking data) are compared and systematic differences attributed to various system error sources for post-mission performance analysis.

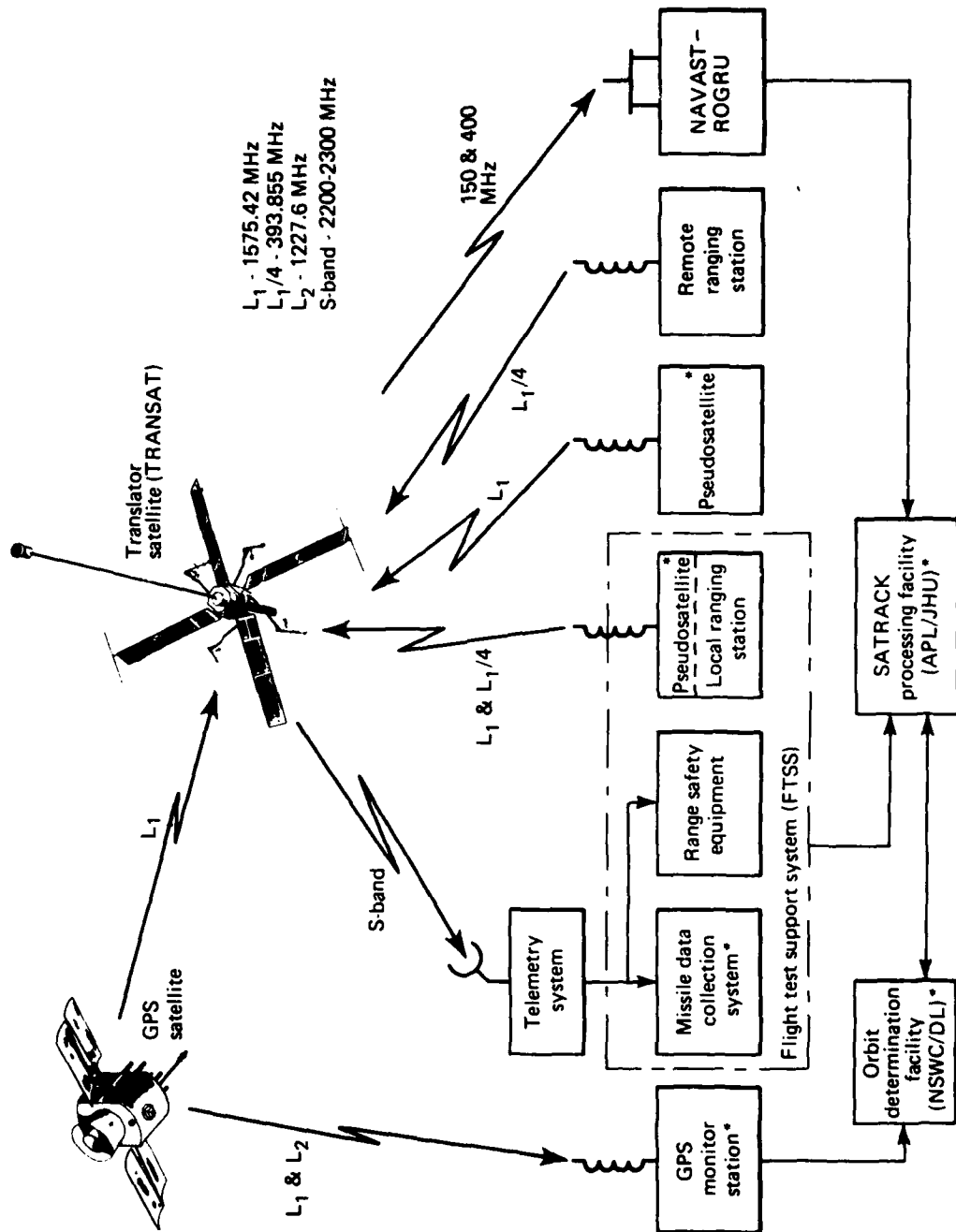

\* SATRACK mode only

Fig. I-36 TRANSAT in SATRACK/Range Safety Test Configuration

2. Range Safety Tests. In the Translator mode, TRANSAT may serve as a test vehicle to receive, translate, and retransmit the transmitted range safety signals from ground based stations. Basically, the Range Safety concept involves the determination of range sum/range-rate sum from the rf time delays and doppler shifts between the missile and the various transmitter stations at widely based locations. A Local Ranging Station (LRS) and four Remote Ranging Stations (RRSs) transmit  $L_1/4$  signals to the missile which are translated to S-band, and transmitted with a pilot carrier to the FTSS (Fig. I-36) Both doppler and time delay signal processing are used at the FTSS to determine missile state vectors in real time. These data are then used to provide PIP for range safety decisions.

*Transit Mode Utilization:*

When not required for translator operations, TRANSAT serves as an operational satellite of the Transit Navy Navigation Satellite System. Oscillator selection by ground command allows normal Transit operations to be resumed when desired. Refer to the article beginning on page I-61 for a description of the Oscar (Transit) satellite, and to Appendix B for a functional description of the Navy Navigation Satellite System.

Physical Characteristics

Body: Octagonal prism, 45.1 cm across flats by 30.28 cm high; topped with octagonal translator penthouse, 40.01 cm across flats by 45.72 cm high.

Solar Blades (4): Cells mounted on 167.6 cm by 25.4 cm substrates.

Weight: 92.31 kg.

Features (Fig. I-37)

Telemetry Subsystem: PAM/FM/PM 35 channel system normally modulating the 150 MHz carrier on command or automatically for tow minutes following memory injection. In the SATRACK mode, TM is switched to the 150 MHz carrier on command and also automatically when the translator is commanded on.

Doppler Subsystem: Dual oven-controlled 5 MHz ultrastable quartz crystal oscillators, one with an offset of -140 ppm (SATRACK mode) and the other with an offset of -80 ppm (Transit mode) whose outputs are multiplied to provide the 150 and 400 MHz carriers (at 0.8 and 1.25 watts, respectively) which supply the doppler data for satellite tracking.

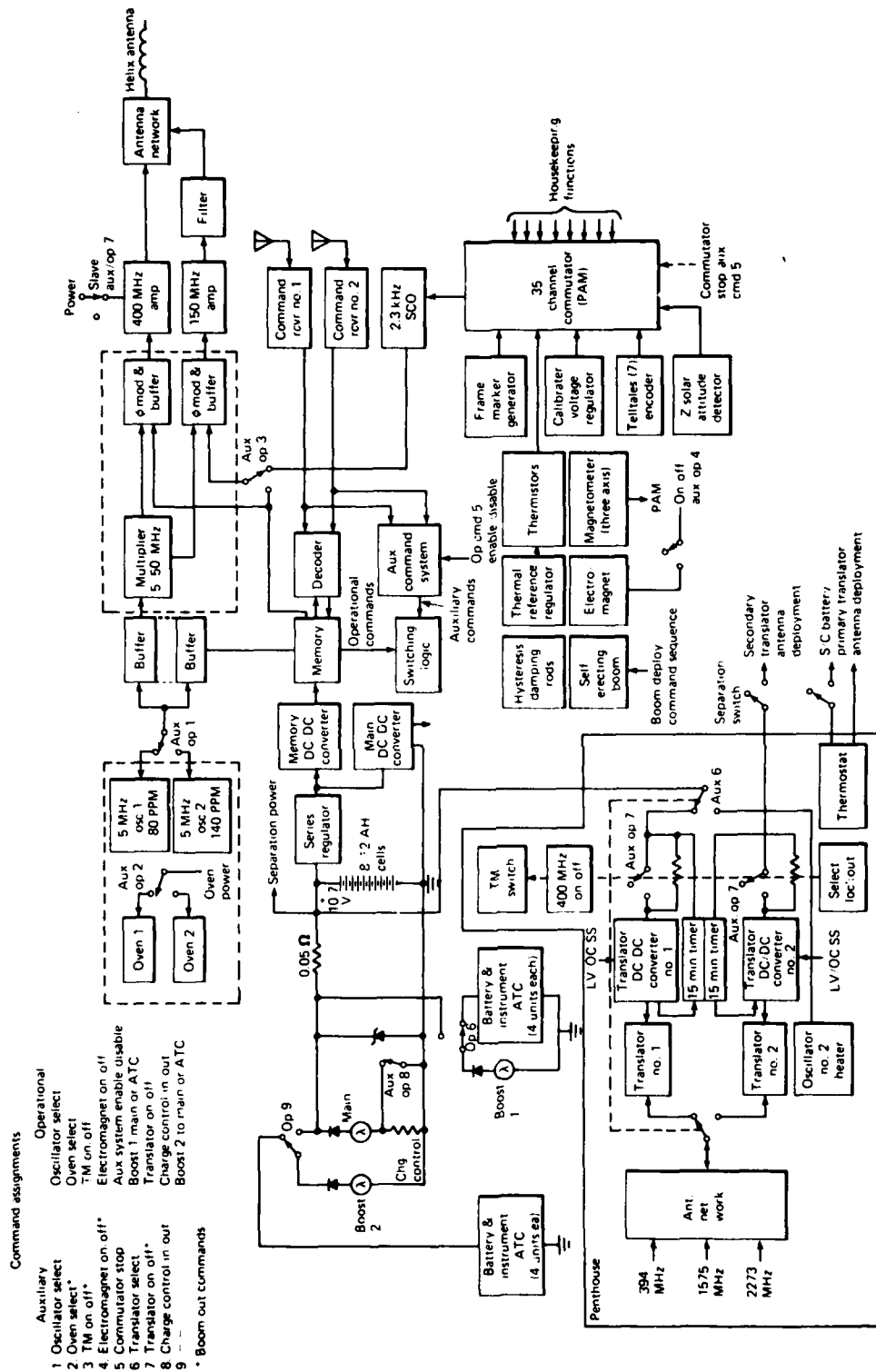

Fig. I-37 TRANSAT Functional Block Diagram



**Memory Subsystem:** Coincident current magnetic core memory with a capacity of 24,960 bits, and a digital clock. Every two minutes, in the Transit Mode, a 6103-bit navigation data message is read out of the memory for redundant transmission on both carriers. The position of the satellite is thus provided for each two-minute fiducial time mark. Timing accuracy is a function of the satellite oscillator stability and is precisely controlled by the use of time correction bits transmitted from ground stations.

**Command Subsystem:** Redundant receivers and antennas, power switching logic, and auxiliary digital command logic provide nine operational and nine auxiliary command functions for control of power, telemetry, translator, and other critical subsystems and permit the selection of redundant units.

**Power Subsystem:** N/P solar cell arrays charge one 12 AH battery of eight nickel cadmium cells and supply power to satellite electronic equipment during sunlit portion of orbit. During eclipse portion of orbit, the battery provides the required power.

**Thermal Control Subsystem:** The mean temperature of the satellite is maintained at about 21.1°C by 16 automatic temperature control (ATC) units attached to the individual battery modules and certain electronic books, and by a passive control system consisting of thermal control coatings and insulation.

**Attitude Control and Detection Subsystem:** (1) a mechanical (yo-yo) despin system plus magnetic hysteresis rods in two solar panels for initial and residual spin removal, (2) an electromagnet for orienting and aligning satellite with earth's local magnetic meridian, (3) an extended gravity-gradient stabilizing boom with end mass for orienting satellite along local vertical, and (4) three directionally oriented (X-, Y-, and Z-axis) magnetometers and a positive Z-direction solar attitude detector for monitoring satellite attitude.

**Translator Subsystem:** Two redundant translators and associated electronics, housed in the penthouse structure, are used to simulate the tracking signals transmitted by a missile under test and thus provide the means for evaluating many SATRACK/Range Safety system components and data processes prior to actual missile flight tests.

### Objectives

1. Permit the realistic evaluation of the FTSS and supporting equipment prior to actual Trident missile test flights. (The FTSS and support equipment required to fulfill the Range Safety and SATRACK signal generation/data recording functions is commonly referred to as the Missile Tracking Instrumentation System, MTIS).
2. Provide a data base for checkout of the SATRACK Processing Facility.
3. Provide test and calibration data for GPS satellites.
4. Provide test signals for checkout and evaluation of Trident missile test support elements, i.e., the Telemetry Doppler Metric Measurement System (TDMMS) and the telemetry receiving system.
5. Serve as an operational satellite of the Navy Navigation Satellite System.

### Achievements

Transit and Translator mode readiness checks were conducted during the initial TRANSAT postlaunch period, and satisfactory operation of all satellite systems was confirmed. At present, during satellite passes over APL, the translators are exercised to provide test signals for validating SATRACK Processing Facility hardware, software, and data processing techniques.

In addition, during tests at Grand Bahama Island the satellite translators were used in conducting Range Safety ranging processor software checkout tests using the Remote Ranging Stations and the Local Ranging Station. Also, for tests at the USAF Eastern Test Range, the translators were used to provide simulated doppler telemetry signals for checkout of TDMMS hardware/software and S-band antenna system acquisition techniques.

ANNA-1A and -1B SATELLITES

ANNA-1A

ANNA-1B  
(1962 8  $\mu$ 1)

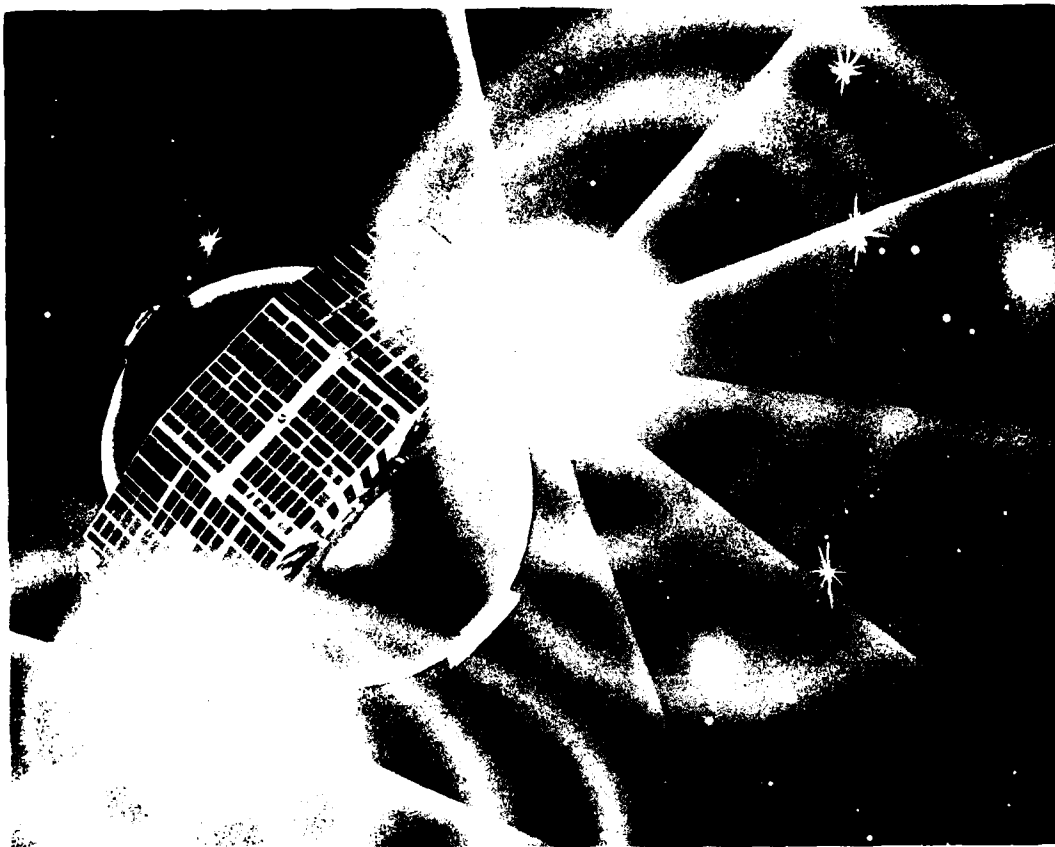

Fig. II-1 ANNA-1B Satellite, Artist's Concept

ANNA-1A AND -1B SATELLITES

Launch: (ANNA-1A) 10 May 1962; Kennedy Space Center, Florida  
(ANNA-1B) 31 October 1962; Kennedy Space Center, Florida

Vehicle: Thor-Able-Star (two stage)

Orbit: (ANNA-1A) Not achieved  
(ANNA-1B) Apogee 1189.6 km (642 nmi), perigee  
1084 km (585 nmi), inclination 50.1°

Remarks: The ANNA-1A boost vehicle malfunctioned and was  
destroyed; the ANNA-1B launch was nominal.

Background

The ANNA (Army, Navy, National Aeronautics and Space Administration, and Air Force) satellites were the first all-geodetic research satellites designed to mark positions on earth, locate the center of earth's mass, and measure the strength and direction of the earth's gravitational field. Overall coordination of the joint program effort was by the Bureau of Naval Weapons; APL was assigned responsibility for satellite fabrication and technical direction.

Physical Characteristics (Fig. II-1)

Body: Sphere, 91.44 cm (36 in.) dia  
Solar Cells: Mounted equatorially  
Weight: (ANNA-1A) 152.73 kg (339.4 lb)  
(ANNA-1B) 157.50 kg (350 lb).

Features (Figs. II-2 and II-3)

Two oven-controlled crystal oscillators (ANNA-1B; 7 parts in  $10^{11}$  and 6 parts in  $10^{11}$ )  
Transmitters: 54, 136, 162, 216, 224, 324, and 449 MHz  
Power: Three separate solar cell generator/nickel-cadmium battery power supplies  
Magnetic stabilization  
Magnetic hysteresis despun

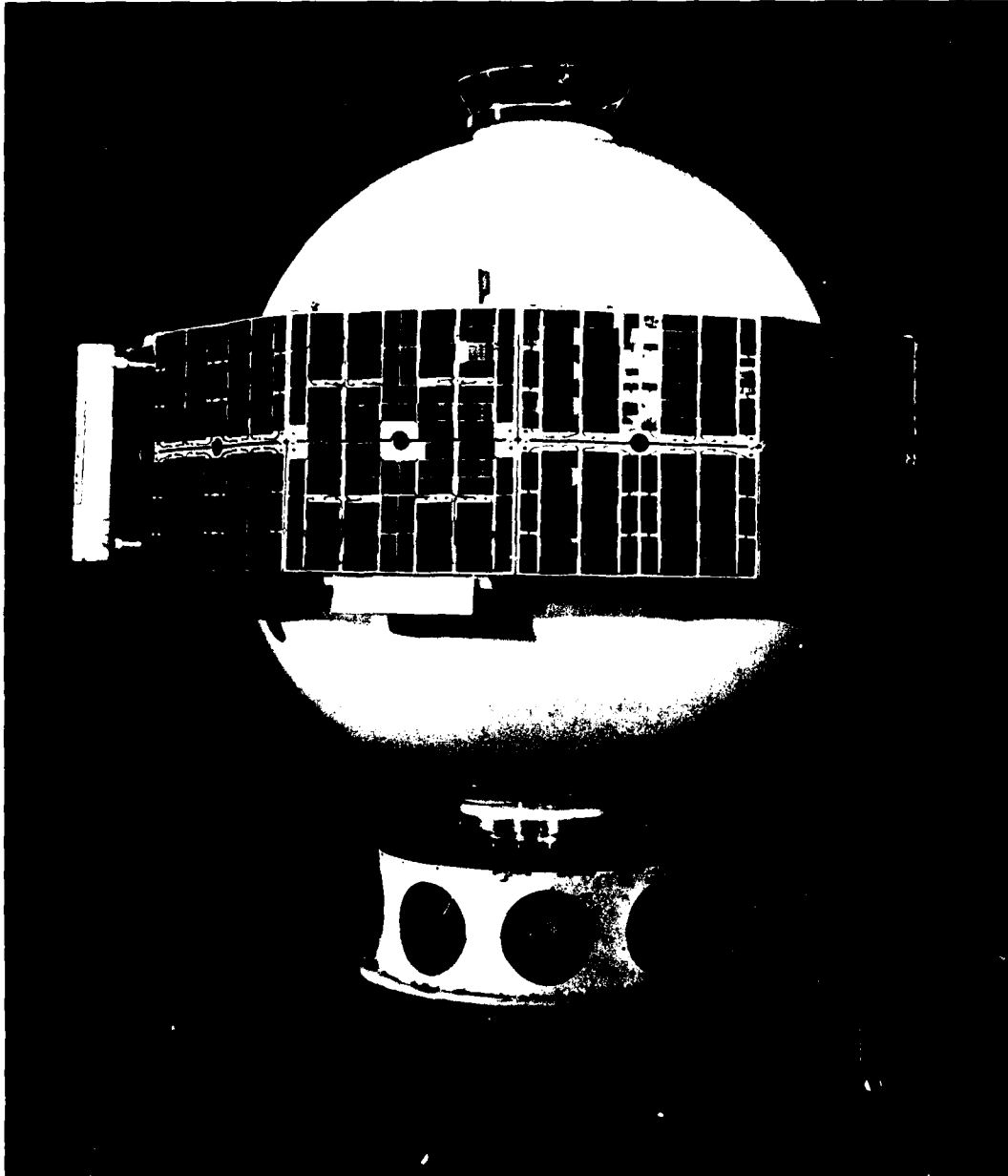

Fig. II-2 ANNA-1A Satellite

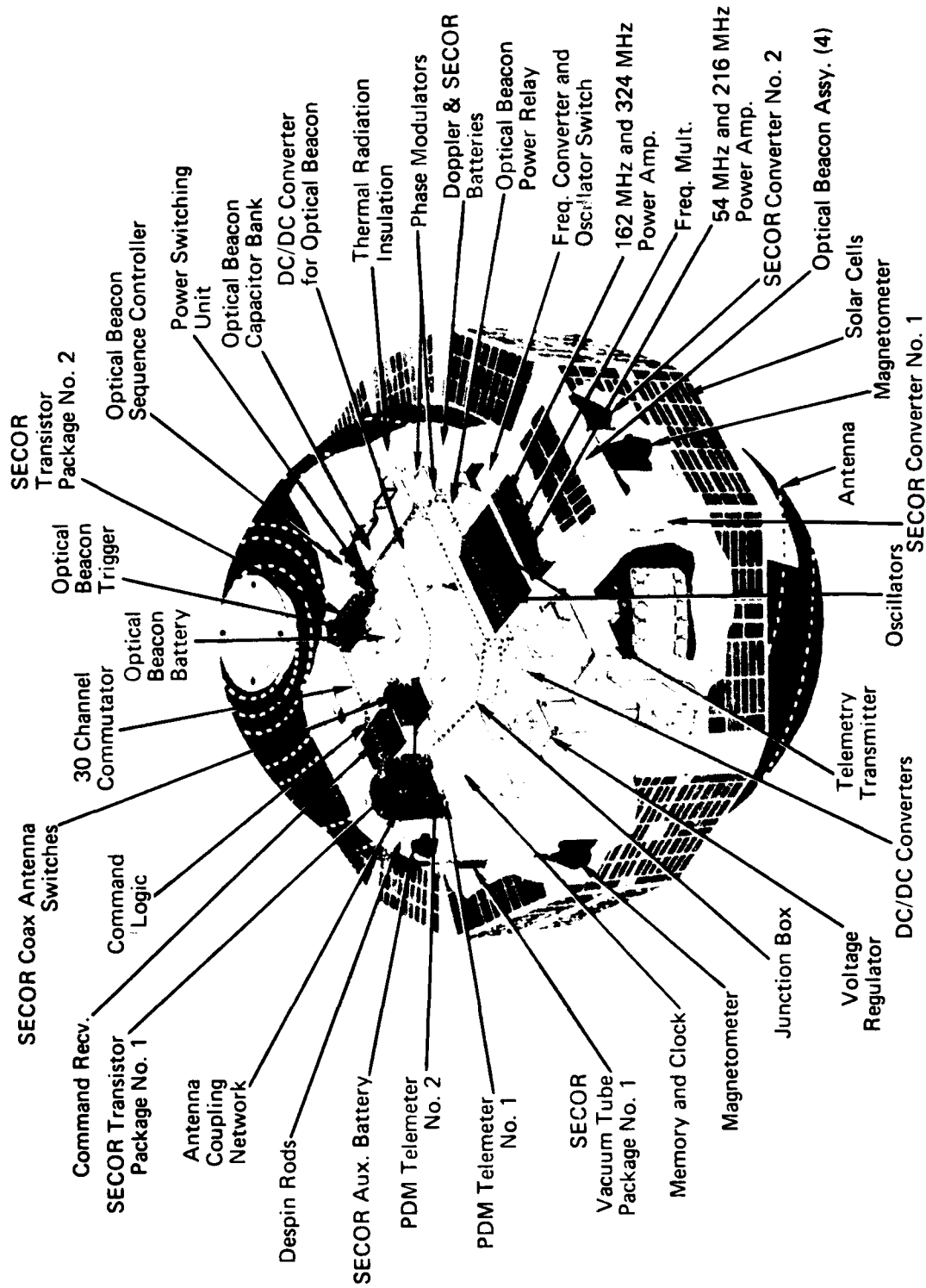

Fig. II-3 ANNA-1B Satellite, Cutaway View

Solar cell experiments

Subliming materials experiment

352-bit magnetic core shift register memory and optical flash counting system

Four high-intensity optical beacons

Radio ranging transponder system

Command system: Four 4-state command logics plus light programming memory injection and real-time light flash capability

Telemetry: 30 channels FM/PM and two channels of long-term analog FM/PM (3 VCOs) on 136 MHz carrier

Antennas: Log spiral silver-painted on hemispheres.

### Objectives

1. Increase knowledge of the earth's shape.
2. Improve mapping capabilities.
3. Furnish means of three independent and different checks (Radio Doppler, Transponder, and Optical Beacon Systems) to validate geodetic measurements.

### Achievements (Fig. II-4)

#### *Anna-1A:*

The ANNA-1A satellite did not achieve Orbit due to the failure of the second-stage rocket to ignite.

#### *Anna-1B:*

All launch objectives were met by ANNA-1B. The independent flashing light and doppler measurement systems agreed within 20 meters or better. A range transponder system designated SECOR (Sequential Collation of Range) was orbited in ANNA, but became inoperable so that useful data were not obtained.

Participating in the world geodetic research program of ANNA were:

Naval Observatory, Washington, D.C.  
Air Force Cambridge Research Laboratory, Bedford, Mass.  
Army Map Service, Washington, D.C.  
Naval Weapons Laboratory, Dahlgren, Va.  
Coast and Geodetic Survey, Washington, D.C.



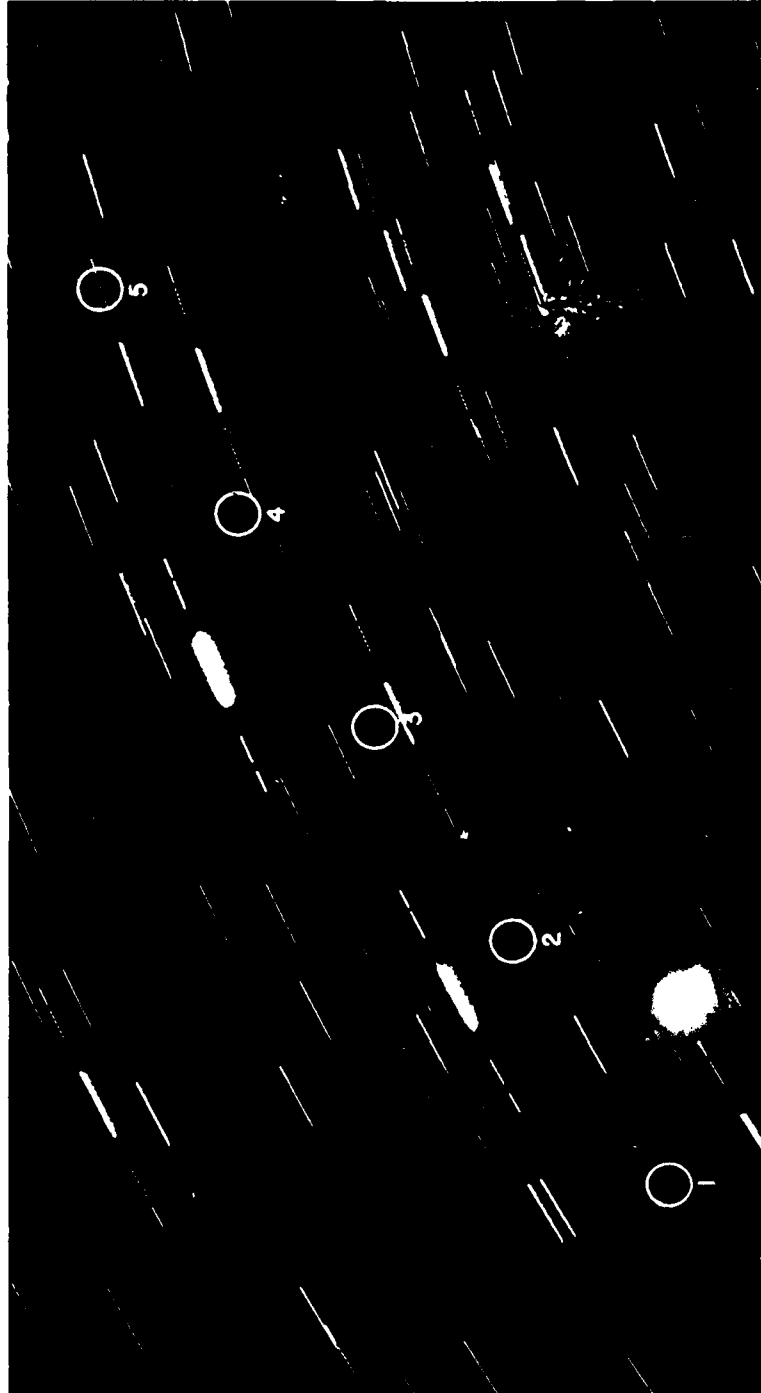

Enlargement of photographic plate taken during a strobe light test on 2 November 1962 to check out AFCRL ANNA-1B optical system. The satellite was photographed as it crossed the Boston area at 0350 hrs EST with a BC-4, 300 mm FL camera located at Aberdeen, Md. The images on the camera plate averaged 50 to 55 microns in size. Photo by USC&GS.

Fig. II-4 ANNA-1B Optical Beacon Test

Ballistic Research Laboratory, Aberdeen, Md.  
Navy Hydrographic Office, Washington, D.C.  
Air Photographic and Charting Service, Orlando, Fla.  
Aeronautical Chart and Information Center, St. Louis, Mo.  
U.S. Naval Ordnance Test Station, China Lake, Calif.  
Pacific Missile Range, Point Mugu, Calif.  
Atlantic Missile Range  
Air Force Space Systems Division, Los Angeles, Calif.  
Geodesy, Intelligence, and Mapping Research and Development  
Agency, Fort Belvoir, Va.

ANNA-1B, while maintained silent, continues operable. In January 1963, a malfunction of a capacitor bank in the optical beacon system resulted in intermittent flash operation. This was self-healing so that in July 1963, the system again became fully operational and has remained so.

Measurements made on the characteristics of solar cells in the natural and artificial radiation belts were significant in that they influenced the design modification for future satellites. The first gallium arsenide solar cell was orbited on ANNA-1B.

The predicted sublimation rates of biphenyl, camphor, and naphthalene were confirmed in the space environment. These data were later used in the design of separation-system devices.

GEOS-A and -B SATELLITES

GEOS-A  
(1965 89A)

GEOS-B  
(1968 02A)



Fig. II-5 GEOS-A Satellite, Artist's Concept

GEOS-A AND -B SATELLITES

Launch: (GEOS-A) 6 November 1965; Kennedy Space Center, Florida  
(GEOS-B) 11 January 1968; Vandenberg AFB, California

Vehicle: Thrust Augmented Thor Delta (GEOS-A, X-258 third stage; GEOS-B FW-4 third stage)

Orbit: (GEOS-A) Apogee 2273.6 km (1227 nmi), perigee 1111.8 km (600 nmi), inclination 59.38°  
(GEOS-B) Apogee 1580.6 km (853 nmi), perigee 1084 km (585 nmi), inclination 105.8°

Remarks: (GEOS-A) Vehicle second stage burned to completion thereby exceeding nominal 1482 km (800 nmi) apogee; despin and separation normal  
(GEOS-B) Orbital parameters were close to nominal.

Background

The GEOS-A and -B (Geodetic Earth Orbiting Satellite) satellites (Explorers 29 and 36, respectively) were the first of the NASA Explorer series designed exclusively for geodetic studies. Satellite data were to augment the National Geodetic Satellite Program (NGSP), a coordinated undertaking of NASA, DoD, and the Department of Commerce (USC&GS).

Physical Characteristics (Fig. II-5)

Body: Truncated octagon with hemispherical spiral antenna  
Solar Cells: Body mounted  
Weight: (GEOS-A) 176.13 kg (391.4 lb)  
(GEOS-B) 210.60 kg (468 lb).

Features (Figs. II-6 and II-7)

Two oven-controlled crystal oscillators  
Transmitters: 136.83 MHz (GEOS-A) or 136.32 MHz (GEOS-B) TM, 162/324/972 MHz, 224.5 MHz, and 1705 MHz; also 5765 MHz (GEOS-B)

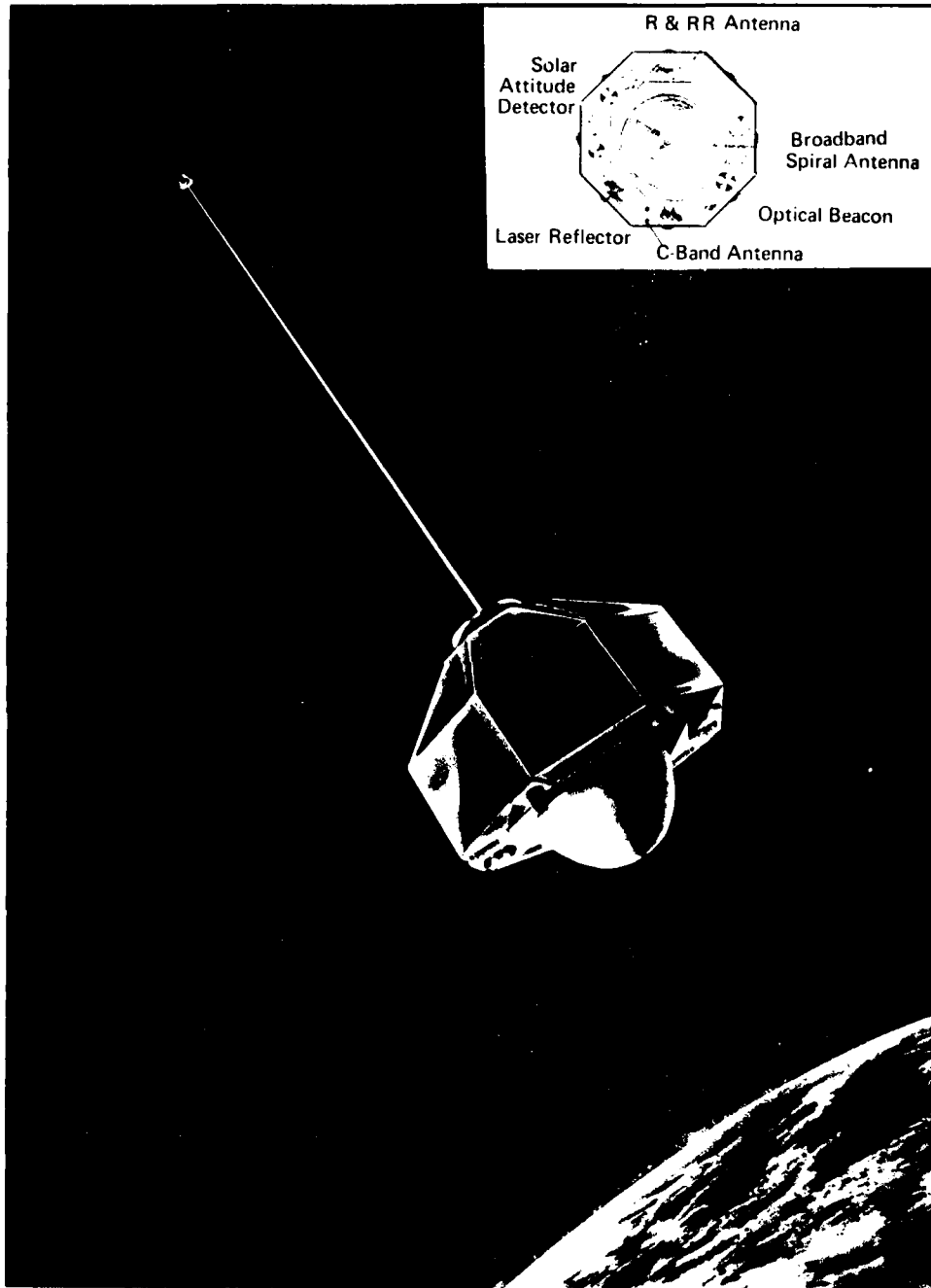

Fig. II-6 GEOS-B Satellite, Artist's Concept

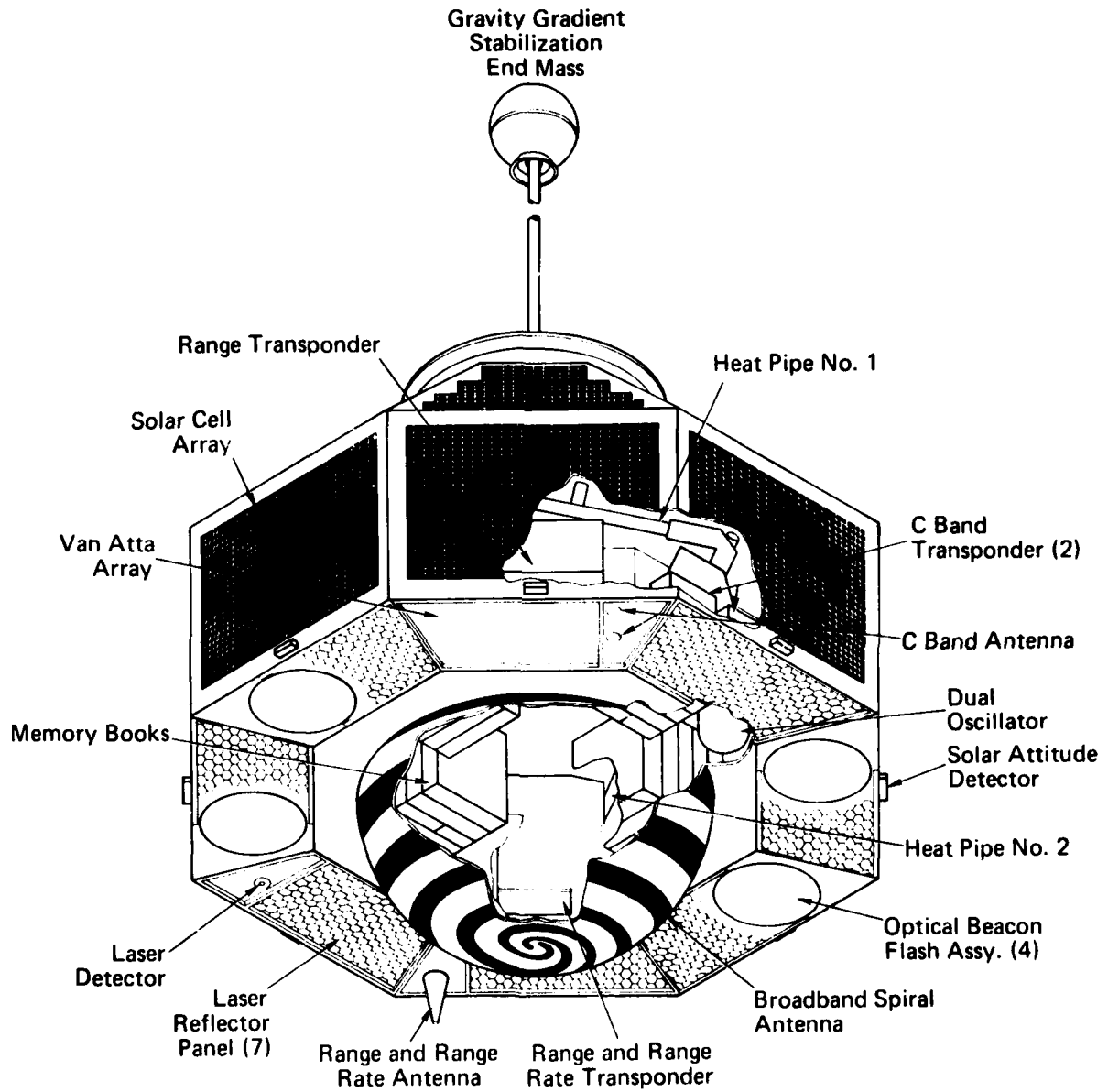

Fig. II-7 GEOS-B Satellite, Cutaway View

Gravity gradient stabilization system with magnetically anchored eddy current damper and motorized boom

Eddy current rod despin system (GEOS-A)

Integrated circuit memory and digital clock

Vector magnetometer system

Solar aspect detector system (dual on GEOS-B)

Command logic and switching circuits: (GEOS-A) 64 for 32 on/off commands; (GEOS-B) 64 for 29 on/off commands plus three 4-position diamonds

Telemetry: (GEOS-A) Analog PAM/FM/PM system consisting of two 38-channel commutators modulating 136.83 MHz carrier; (GEOS-B) Analog PAM/FM/PM system consisting of one 76-channel commutator and one 38-channel commutator modulating the 136.32 MHz carrier. Two sub-commutators of eight functions each monitored the optical system (when in use only) on one channel of each of the two commutators

Antennas: Hemispherically mounted equiangular spiral slot antenna, Range and Range Rate transponder cone antenna, and (GEOS-B) two C-band button type circularly polarized antennas

Additional GEOS-B features: Heat pipes, C-band passive radar reflector, laser detector, solar science electron detector, and solar array monitor.

#### Geodetic Instrumentation

Optical beacon system (four Xenon flash assemblies)

Navy radio doppler system (162/324/972 MHz)

Army range transponder (421 MHz uplink, 224.5 and 449 MHz downlink)

GSFC range and range rate transponder (2270 MHz uplink and 1705 MHz downlink)

Laser corner reflector panels

(GEOS-B) C-band transponders (one minimum fixed internal delay and one fixed long internal delay) both at 5690 MHz uplink and 5765 MHz downlink.



### Objectives

1. Provide a means to determine fiducial control point positions on earth to an accuracy of 10 meters in an earth center of mass coordinate system.
2. Determine structure of the earth's gravity field to 5 parts in  $10^8$ .
3. Provide a means for measurement of the geometry of geodetic triangulation networks.
4. Locate isolated islands.
5. Evaluate new high precision satellite measurement techniques.

### Achievements

#### *Geos-A:*

The mission objectives were met. GEOS-A was the first NASA spacecraft to employ gravity gradient stabilization. The spacecraft successfully executed an inversion maneuver shortly after launch in spite of an excessively elliptical orbit. GEOS-A employed the first APL integrated circuit memory and the first APL gravity gradient stabilization system to successfully use the motorized boom.

#### *Geos-B:*

GEOS-B met all launch objectives. While one of a pair of redundant memories and the electron precipitation experiment failed during powered flight, this did not impair accomplishment of the primary mission objectives.

THE JOHNS HOPKINS UNIVERSITY  
APPLIED PHYSICS LABORATORY  
LAUREL, MARYLAND

SDO 1600  
May 1975

LIDOS SATELLITE

II-17

REPRODUCING PAGE BLANK-NOT FILMED

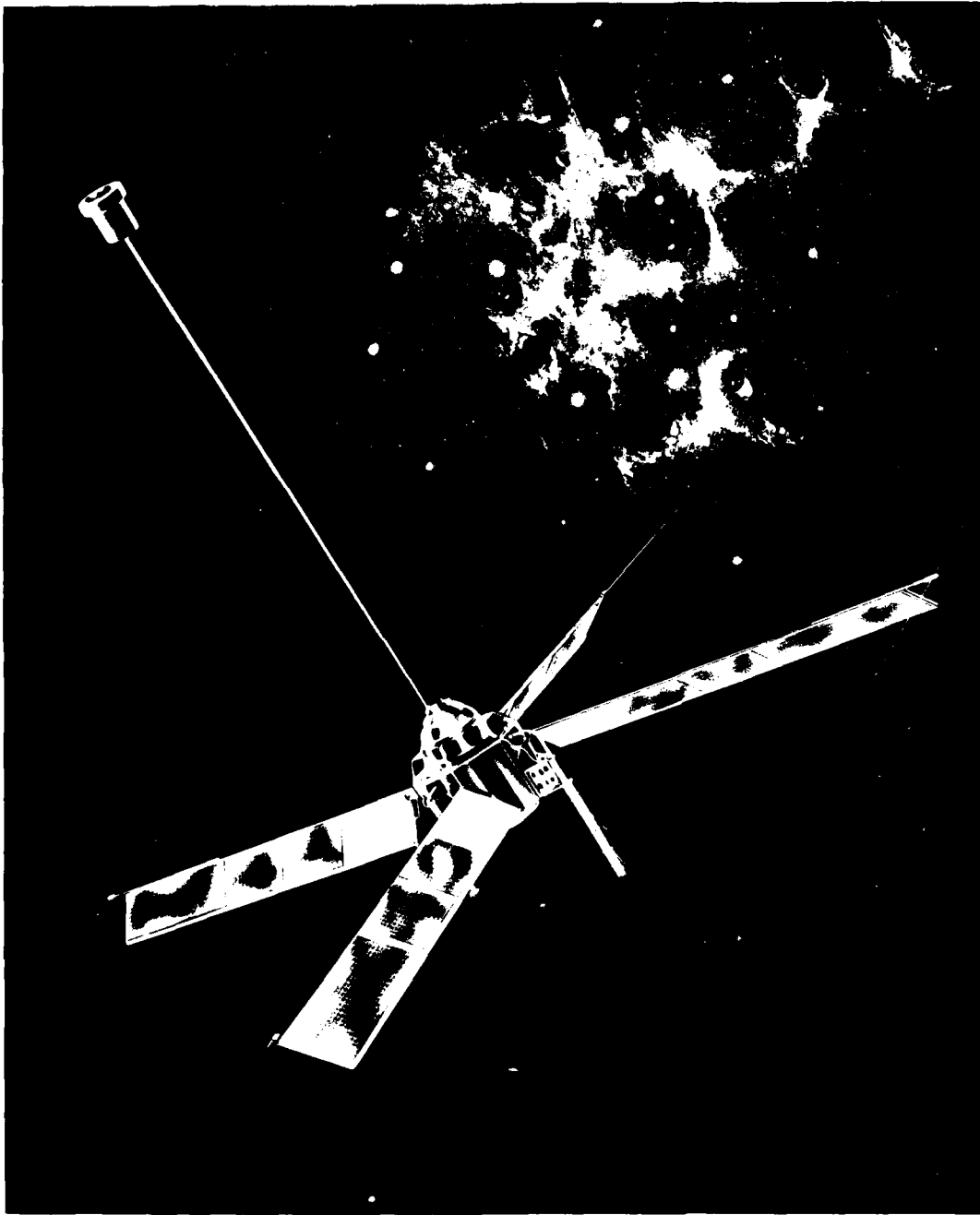

Fig. II-8 LIDOS Satellite, Artist's Concept

### LIDOS SATELLITE

**Launch:** 16 August 1968, Vandenberg AFB, California  
**Vehicle:** Atlas (SLV-III)/Burner II  
**Orbit:** Not achieved  
**Remarks:** The vehicle heat shield failed to jettison and the payload was lost.

#### Background

Doppler tracking data from satellites in a variety of different orbits are analyzed to improve the coefficients of the geopotential model. At the time of LIDOS (Low Inclination Doppler Only Satellite), data from seven different satellites had been used in calculating the harmonic coefficients. The orbits of these satellites differed mainly in inclination. The LIDOS inclination of  $96^{\circ}$  was to increase the coverage of inclinations which ranged from  $33^{\circ}$  to  $106^{\circ}$ , and it was equally important that the data were from a satellite with a much higher orbit eccentricity and altitude.

#### Physical Characteristics (Fig. II-8)

**Body:** Octahedron, 45.72 cm (18 in.) across flats and 30.48 cm (12 in.) high

**Appendages:** Self-erecting boom, 1800 cm (60 ft) long with 2.25 kg (5 lb) end mass, and perigee kick rocket motor on top side; four solar cell blades each 165 cm (5.5 ft) long and with an antenna on the outer end; and two brackets supporting turnstile antennas pointing earthward mounted on two sides

**Weight:** 55.22 kg (122.7 lb).

#### Features

**Transmitters:** 54, 162, 324, and 972 MHz

**Power:** Solar array/Ni-Cd batteries (32 watts peak)

**Yo-yo despin system**

**Gravity gradient stabilization**

Hysteresis rod libration damping  
Magnetic stabilization  
Vector magnetometers (3)  
Solar aspect sensors (4)  
Telemetry: One 35-channel, reed-relay commutator driving a 2.3 kHz subcarrier oscillator to provide phase modulated signals on the 162 and 324 MHz transmissions  
Command System: Dual command receiver, dual command logic, and power switching circuitry providing 16 on/off commands  
Orbit Adjustment Motors: Perigee adjustments motor mounted on top of satellite. Apogee adjustment motor is mounted in satellite bus  
Antennas: Four dipole antennas and three turnstile antennas.

### Objectives

The primary LIDOS mission was to obtain data that would be used to improve the knowledge of harmonic coefficients of the earth's gravity field.

The secondary mission objectives were:

1. To contribute to an estimate of GM (earth's mass gravitational constant) and the mean radius of the earth in a way that was independent of the method used in obtaining similar estimates from the Ranger spacecraft.
2. To support areas, in addition to navigation, such as mapping and defining the size and shape of the earth.
3. To increase knowledge of the effects of ionospheric refraction on satellite signals.

### Achievements

Vehicle liftoff was as planned; however, the 990 cm (33 ft) long by 150 cm (5 ft) diameter heat shield failed to jettison and all payloads failed to orbit.

LIDOS was launched with nine other experiments destined for four different orbits. The Burner II stage was to be injected into a  $91.3^\circ$  (retrograde), 741 km (400 nmi) circular

orbit from which it was to then inject the experiments into the necessary orbits. Four experiments, including LIDOS, were mounted in three separate dual propulsion spin-stabilized buses or supports for transfer to higher energy orbits. LIDOS was to be ejected as Burner II crossed the equatorial plane (Fig. II-9) and spun to provide attitude control. A perigee kick and plane change rocket motor mounted on the forward end of the satellite was to be fired, placing the satellite and bus in a new orbit with an inclination of  $91.8^\circ$ , a perigee of 741 km, and an apogee of 1019 km (550 nmi). The spin-oriented LIDOS plus final injection motor were to coast to apogee where the apogee kick and plane change motor mounted on the bus aft end would inject LIDOS and the bus into an orbit  $96^\circ$  inclination, a perigee of 1019 km, and an apogee of 4447 km (2400 nmi).

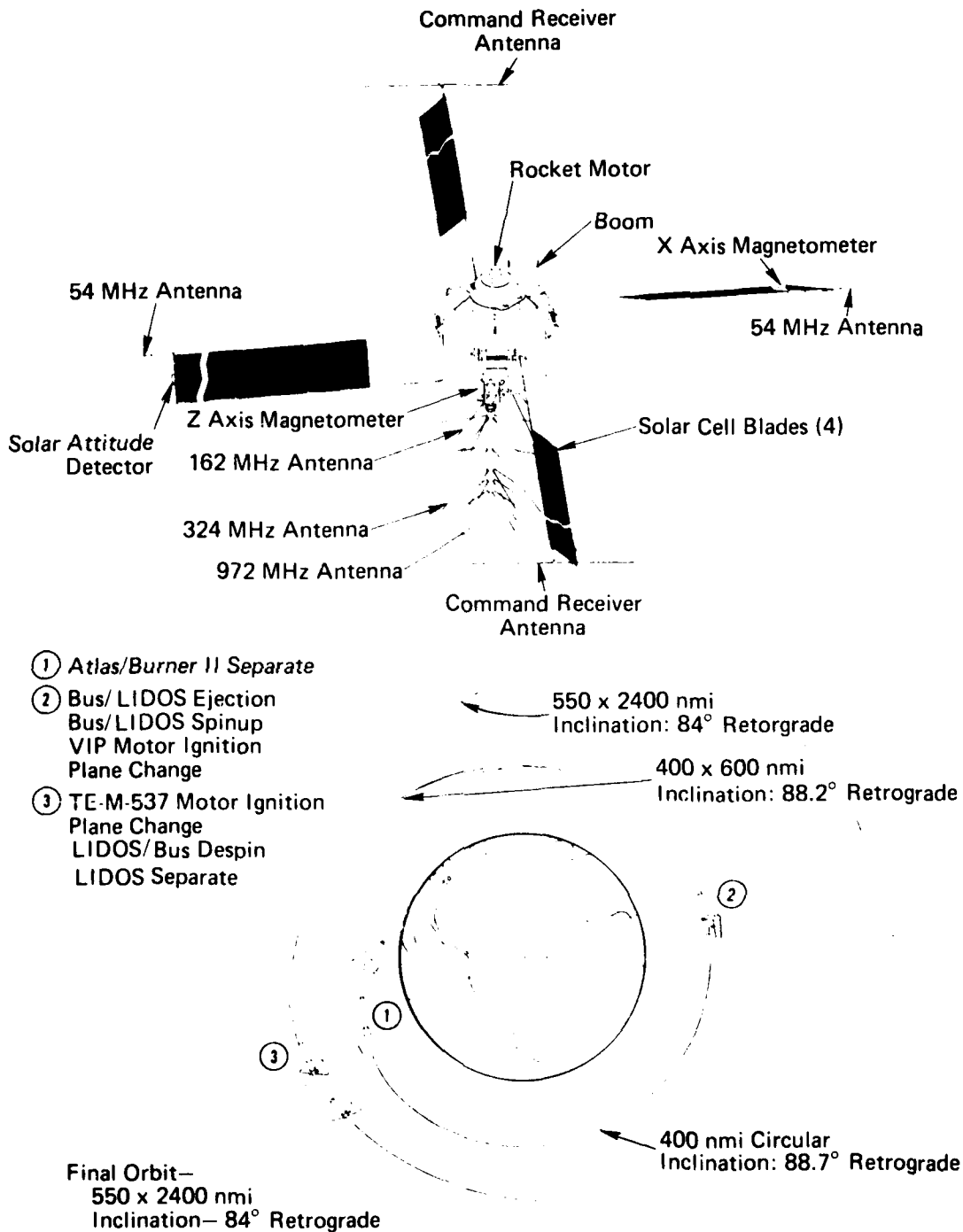

Fig. II-9 LIDOS Orbital Configuration and Launch Sequence

THE JOHNS HOPKINS UNIVERSITY  
APPLIED PHYSICS LABORATORY  
LAUREL MARYLAND

SDO 1600  
May 1975

GEOS-C SATELLITE  
(1975 27A)

II-23



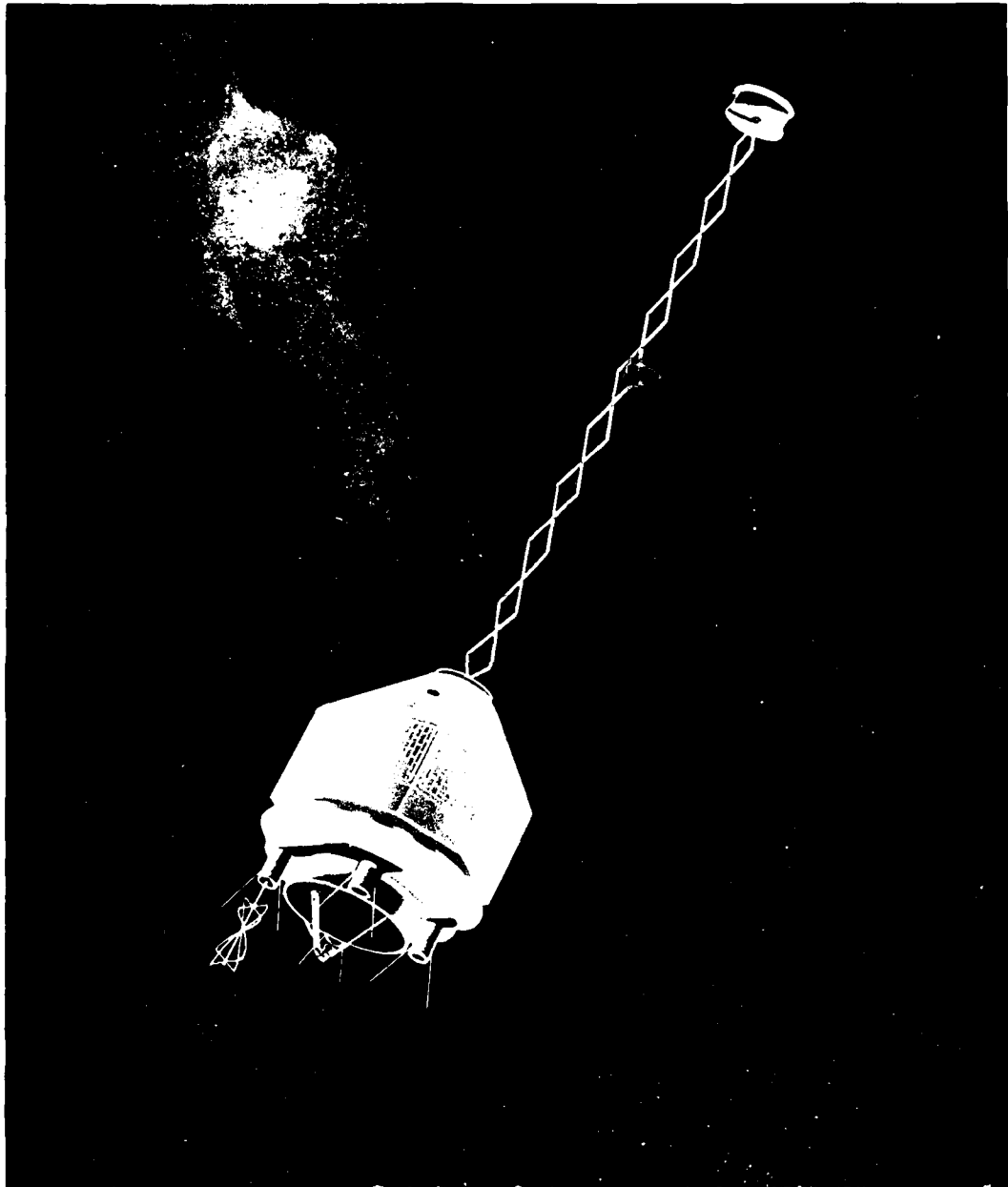

Fig. II-10 GEOS-C Satellite, Artist's Concept

GEOS-C SATELLITE

**Launch:** 9 April 1975; Vandenberg AFB, California

**Vehicle:** Thrust Augmented Thor Delta (two stage)

**Orbit:** Apogee 844.5 km (455.7 nmi), perigee 838.2 km (452.3 nmi), inclination 114.99°

**Remarks:** The Delta rocket was used with four strap-on solid boosters to place the satellite closely to the desired 847 km circular orbit of 115° inclination.

Background

The GEOS-C (Geodynamics Experimental Ocean Satellite) structural configuration is based on the GEOS-B (Geodetic Earth Orbiting Satellite) mechanical design to minimize developmental costs. The GEOS-C Project represents an interim step between the essentially completed National Geodetic Satellite Program (NGSP) and the emerging NASA Earth and Ocean Physics Application Program (EOPAP). As such, the GEOS-C mission objectives are related to both programs.

Physical Characteristics (Fig. II-10)

**Body:** Octahedron topped by truncated pyramid, 132 cm (52 in.) across flats and 81 cm (32 in.) high

**Solar Cells:** Body mounted

**Weight:** 340 kg (750 lb).

Features (Figs. II-11 and II-12)

Two oven-controlled crystal oscillators

**Transmitters:** 136 and 2247 MHz (VHF and S-band TM, respectively), 162/324 MHz, 13.9 GHz, 5.690 GHz, and 5.765 GHz

Gravity gradient stabilization system with magnetically anchored eddy current damper on extendible boom with mass of 45 kg (100 lb), and momentum wheel

Vector magnetometer system

Solar aspect sensors

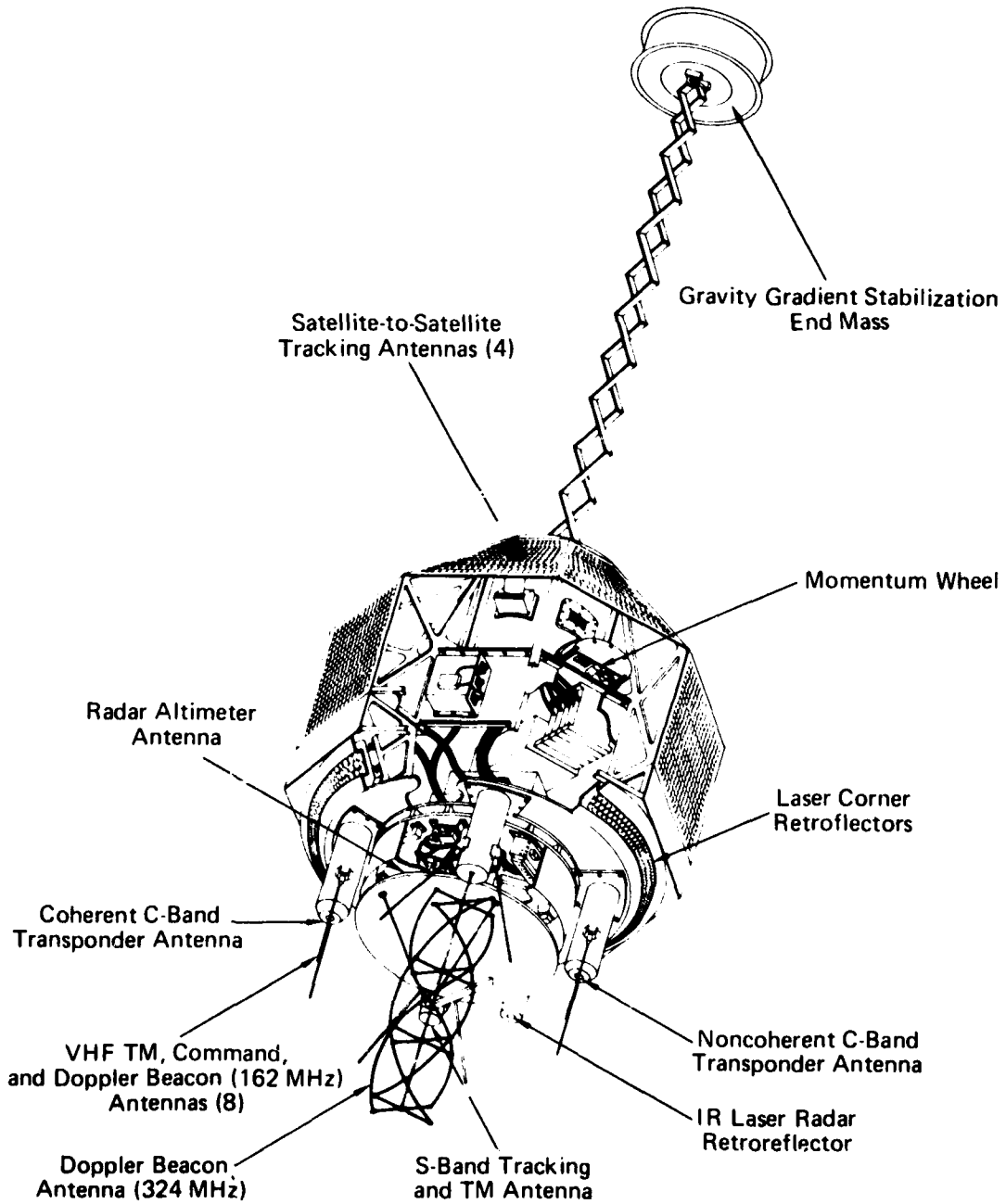

Fig. II-11 GEOS-C Cutaway View

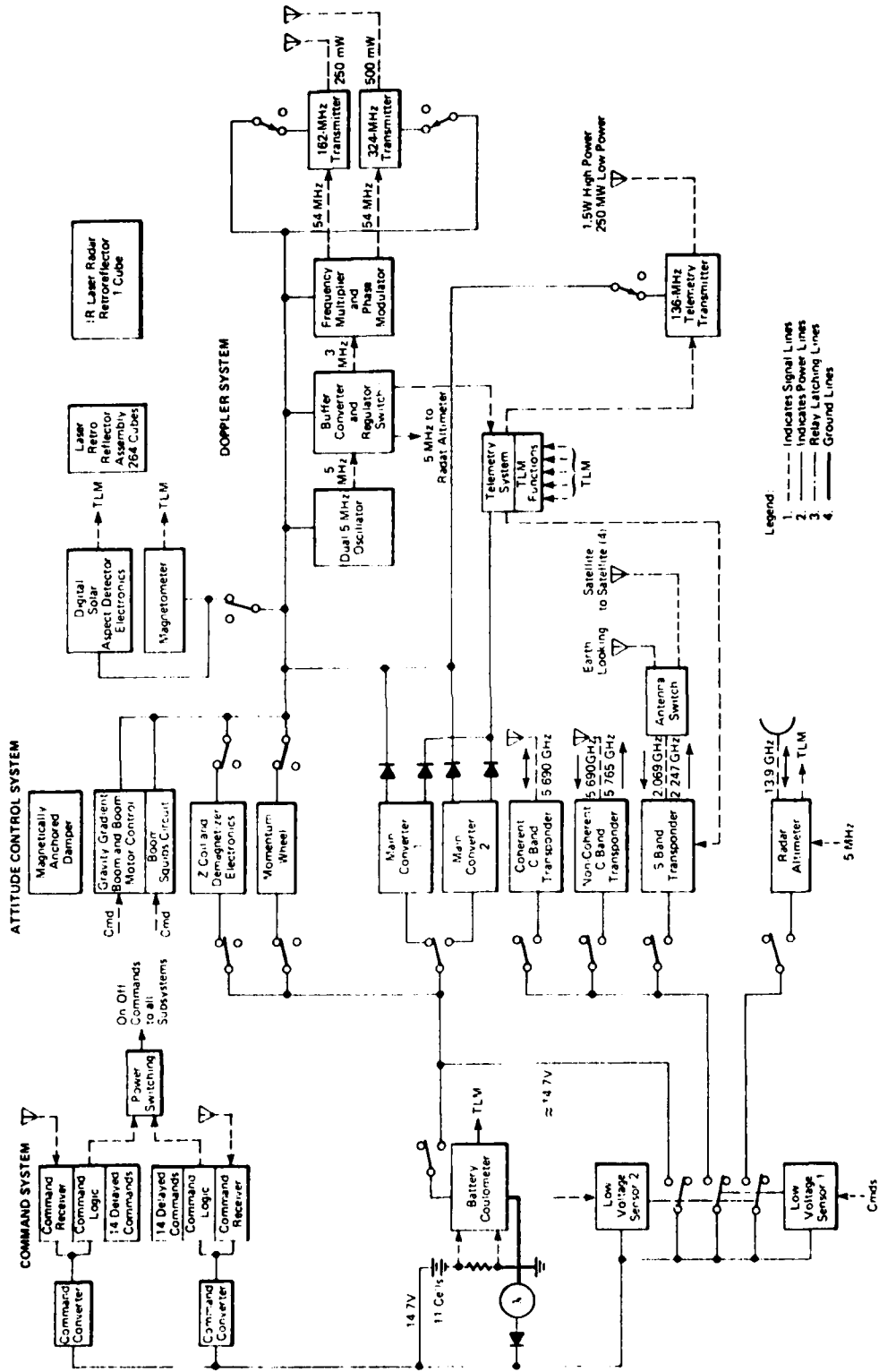

Fig. II-12 GEOS-C Satellite Systems Block Diagram

**Passive thermal design system**

Command system fully redundant with 49 command functions at 64 bps using PCM/FSK-AM/AM modulation, 8 data commands for radar altimeter, and two delayed command subsystems

Telemetry: PCM/PM system capable of transmitting 1,562.42 and 15,624.2 bps on either S-band direct to ground, S-band to ground via ATS-6 satellite, and/or VHF direct to ground

Power: Solar cells/Ni-Cd batteries with battery charge monitor; 14.7 V nominal, 40-53 W orbital average

Geodetic Instrumentation (in priority order):

Radar Altimeter

Coherent C-band transponder

S-band instrumentation for satellite-to-satellite experiments

Laser retroreflector

Doppler transmitters

Noncoherent C-band transponder

S-band instrumentation for earth tracking experiments.

Objectives

1. Perform an in-orbit satellite altimeter experiment to: (a) determine the feasibility and utility of a space-borne radar altimeter to map the topography of the ocean surface with an absolute accuracy of  $\pm 5$  meters, and with a relative accuracy of 1 to 2 meters, (b) determine the feasibility of measuring the deflection of the vertical at sea, (c) determine the feasibility of measuring wave height, and (d) contribute to the technology leading to a future operational altimeter-satellite system with a 10-centimeter measurement capability.
2. Support further the calibration of NASA and other agencies' ground C-band radar systems (Fig. II-13) by providing a space-borne coherent C-band transponder system, to assist in locating these stations in the unified earth-centered reference system, and to provide tracking coverage in support of the radar-altimeter experiment.

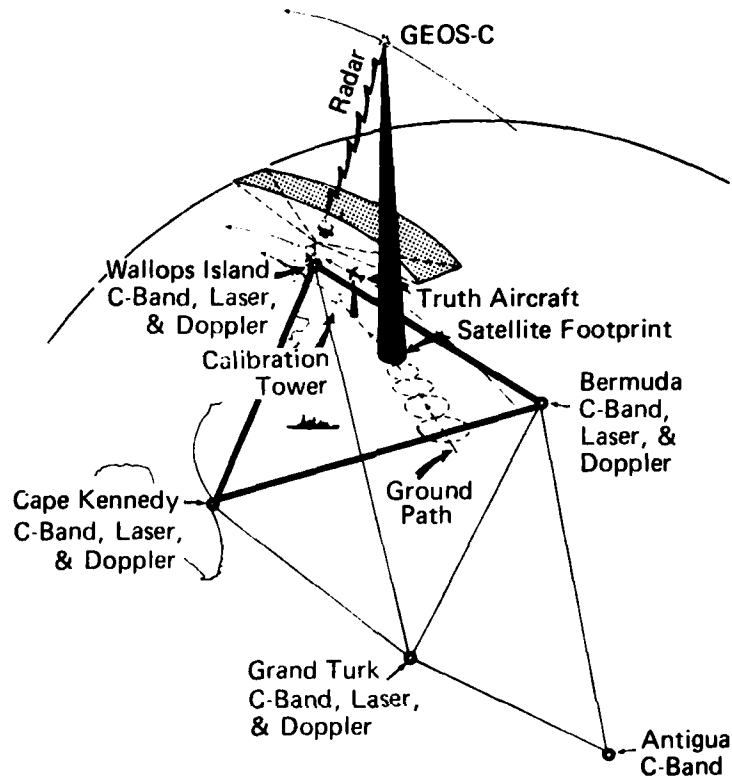

Fig. II-13 GEOS-C Calibration Configuration

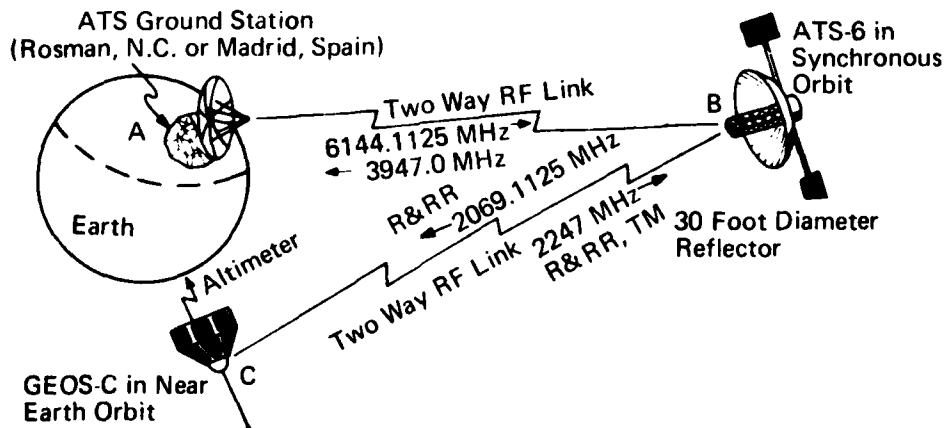

Fig. II-14 Satellite-to-Satellite Experiment Configuration

3. Perform a satellite-to-satellite experiment (SSE) with the Applications Technology Satellite-6 (ATS-6) using an S-band transponder system (Fig. II-14) to directly measure the short period accelerations imparted to the spacecraft by the gravity field and to determine the position of the spacecraft. The anticipated measurement data quality of about .07 cm/sec over a ten-second integration interval will aid in improving the earth gravity model up to spherical harmonic terms of degree and order of approximately 25 and in providing tracking coverage over mid-ocean areas to support the radar altimeter experiment.
4. To further support the intercomparison of new and established geodetic and geophysical measuring systems including: the radar altimeter, satellite-to-satellite tracking, and C-band, S-band, laser, and doppler tracking.
5. To investigate solid-earth dynamic phenomena such as polar motion, fault motion, earth rotation, earth tides, and continental drift theory with precision satellite tracking systems such as laser and doppler ground stations.
6. To further refine orbit-determination techniques, the determination of interdatum ties, and gravity models with a spacecraft equipped with laser retroreflectors, C-band and S-band transponders, and doppler beacons.
7. To support the calibration of the Unified S-Band (USB) sites in the STDN (Space Tracking and Data Acquisition Network) by furnishing a space-borne USB transponder to assist in positioning the network stations in the world reference tracking system, and to assist in evaluating the USB system as a tool for geodesy and precision orbit determination.

#### Achievements

Gravity gradient stabilization of GEOS-C was achieved on 11 April 1975, and all satellite subsystems and experiments were subsequently tested and their performance was as planned. Phase I of the GEOS-C mission, now under way, covers all activities after launch through about one year of experiment data collection. Phase II will cover those activities after Phase I through the remainder of the mission.

Phase I can be subdivided into the following periods according to the extent of experiment data collection, the type of data being collected, and various other operational and physical constraints:

Phase I Period	Days After Launch	Dominant Activity
A	0 to 10	Launch and operational assessment
B	11 to 40	Experiment systems calibration and evaluation
C	41 to 75	Global activities, including SSE data collection
D	76 to 423	Unique experiments and localized grid densifications

Under NASA control, the GEOS-C experiments are being calibrated and evaluated (Period B). Data are obtained daily by doppler TRANET (Tracking Network) stations and used by the Naval Surface Weapons Center (NSWC)/Dahlgren, Virginia for computing a precision satellite ephemeris.



THE JOHNS HOPKINS UNIVERSITY  
APPLIED PHYSICS LABORATORY  
LAUREL, MARYLAND

SDO 1600  
May 1975

TRAAC SATELLITE  
(1961 a $\eta$ 2)

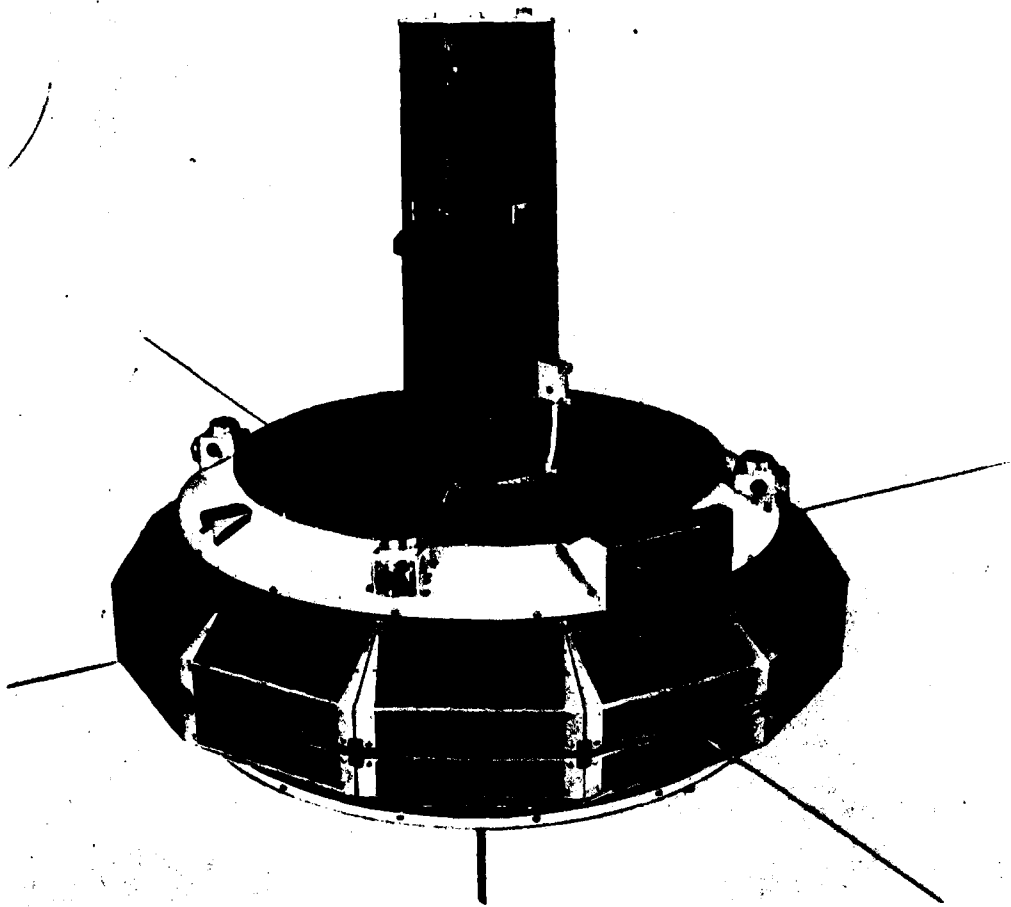

Fig. III-1 TRAAC Satellite

### TRAAC SATELLITE

Launch: 15 November 1961; Kennedy Space Center, Florida  
Vehicle: Thor-Able-Star (two stage)  
Orbit: Apogee 1121 km (605 nmi), perigee 956 km  
(516 nmi), inclination 32.4°  
Remarks: TRAAC was launched pickaback atop Satellite 4-B;  
separation from 4-B was normal.

#### Background

The TRAAC (Transit Research and Attitude Control) satellite was of an asymmetric design and employed an 1800 cm (60 ft) extendable boom as an experiment in gravity gradient stabilization. While primarily intended as a backup for Satellite 4-B, TRAAC was heavily instrumented for particle detection.

#### Physical Characteristics (Fig. III-1)

Body: Doorknob shape, 109.22 cm (43 in.) across by  
104.14 cm (41 in.) high  
Solar Cells: Mounted equatorially and on satellite top  
and bottom  
Weight: 104.76 kg (232.8 lb).

#### Features (Fig. III-2)

RMS oscillator stability: 6 parts in  $10^{11}$   
Transmitters: 54, 136, and 324 MHz  
Power: Solar cells/Ni-Cd batteries  
Magnetic hysteresis despin  
Electromagnet system  
Gravity gradient stabilization system  
Analog and digital solar attitude detectors  
Vector magnetometer system (three axis)  
Spin-rate detectors (8)  
Solar cell experiments

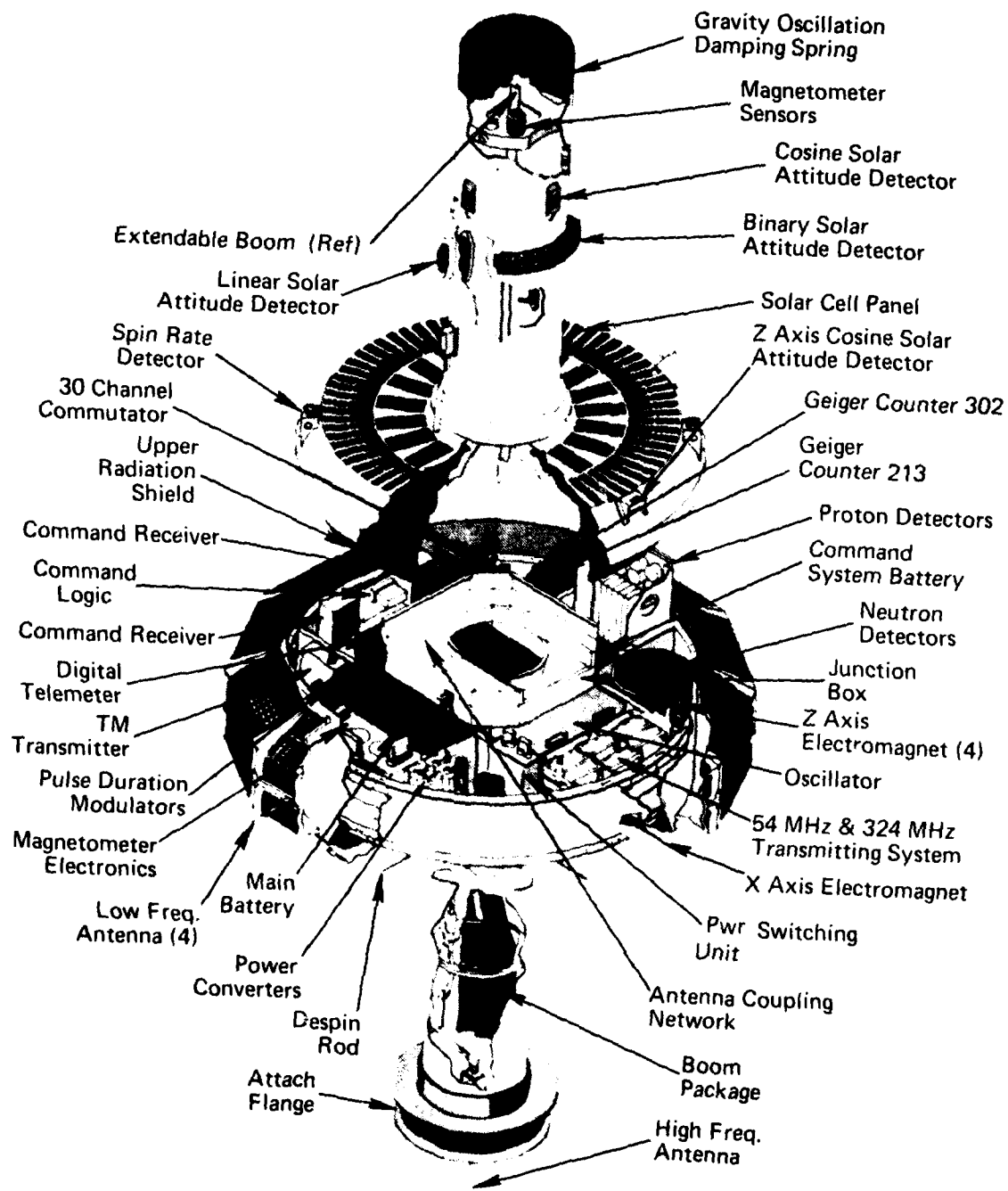

Fig. III-2 TRAAC Satellite, Cutaway View

Subliming materials experiment  
Circuit reliability experiment  
Proton, alpha particle, and neutron detectors (10 total)  
Two Geiger counters  
Telemetry: 30 channel PDM/PAM/FM/PM analog system on  
136 MHz carrier plus binary digital encoder (256 bits/sec)  
Command system: 16 operating modes  
Antennas: A whip antenna and an omnidirectional antenna  
consisting of a turnstile of four single elements.

### Objectives

1. Back up Satellite 4-B with respect to increasing knowledge of earth's gravitational field.
2. Demonstrate the principle of gravity gradient stabilization by which one satellite face may be permanently oriented toward earth.
3. By means of particle detectors: (a) improve the delineation of the number density of protons in the inner Van Allen Belt, (b) search for trapped particles heavier than protons, and (c) check the cosmic ray neutron albedo theory of the origin of the inner Van Allen Belt.
4. Test advanced engineering concepts (such as deployment of a weak "lossy" spring one coil at a time, from a subliming encapsulation, and the damping of libration by means of this spring).

### Achievements

Since Satellite 4-B met all objectives, the first objective was not necessary. Objectives 3 and 4 were met. TRAAC contained the first gravity gradient stabilization system orbited (Objective No. 2). This system responded to the extension command but, shortly thereafter, a drive motor malfunctioned and the 60-foot gravity gradient stabilization boom did not extend fully.

After launch, it was difficult to execute operational commands while the TRAAC doppler transmitters were on, so that this system was maintained in the off position for substantial periods.

TRAAC contributed some early measurement data of the space environment resulting from the Pacific high altitude nuclear tests (Johnson Island). The albedo neutron flux was measured over a nine-month period. The gravity gradient libration damping spring operated satisfactorily.

This satellite was the first to employ electromagnets for temporary magnetic stabilization.

The satellite had an operating life of 270 days. As with Satellite 4-B, the TRAAC power system was greatly affected by artificial radiation and the satellite ceased transmitting 12 August 1962.

THE JOHNS HOPKINS UNIVERSITY  
APPLIED PHYSICS LABORATORY  
LAUREL MARYLAND

SDO 1600  
May 1975

SATELLITE 5E SERIES

5E-1  
(1963 38C)

5E-3  
(1963 49C)

5E-2

5E-5  
(1964 83C)

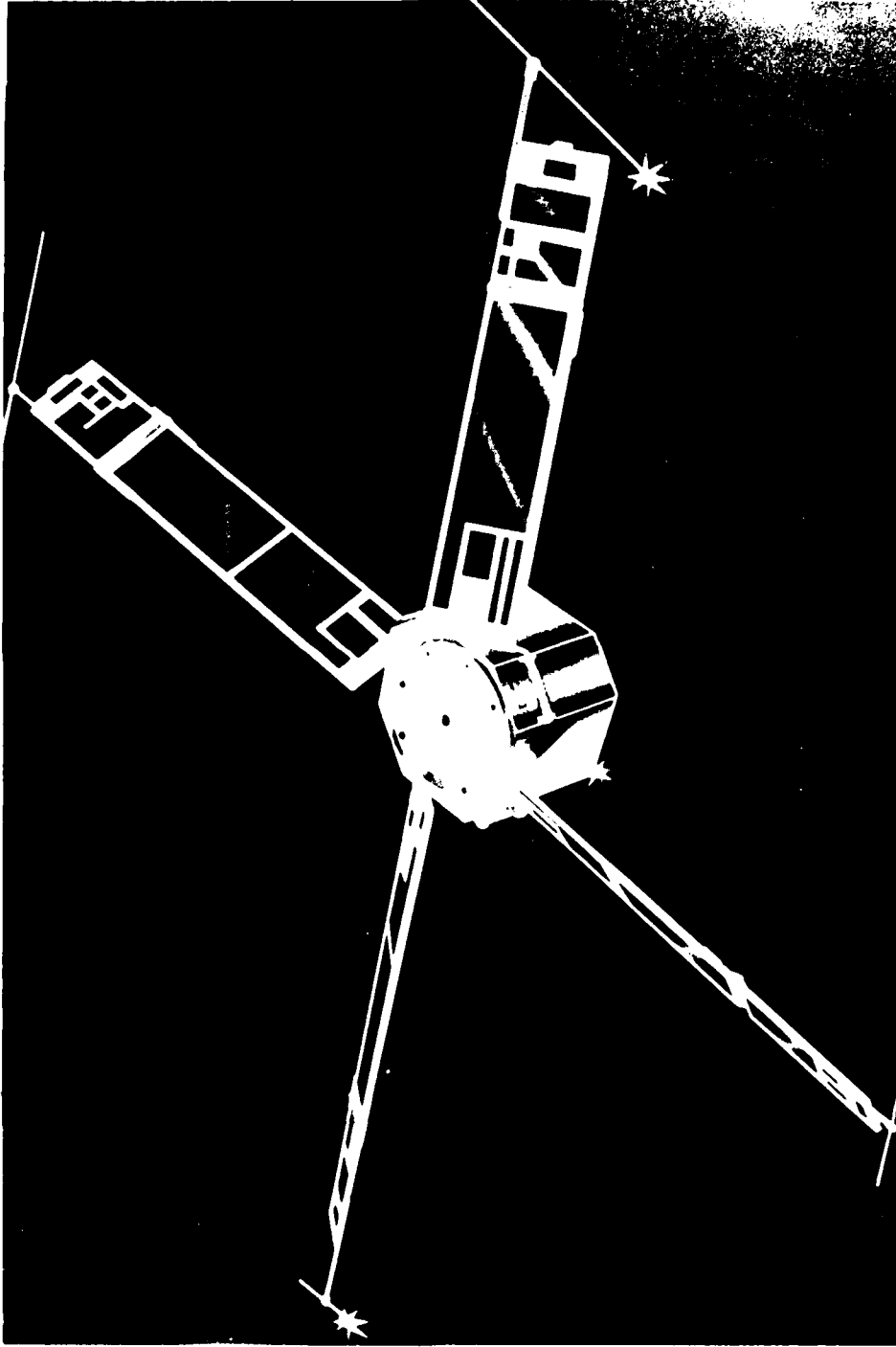

Fig. III-3 Satellite 5E-1, Artist's Concept



SATELLITE 5E-SERIES

**Launch:** All 5E series satellites were launched from Vandenberg AFB, California

(5E-1) 28 September 1963, with pickaback Satellite 5BN-1

(5E-2) 21 April 1964, with pickaback Satellite 5BN-3

(5E-3) 6 December 1963, with pickaback Satellite 5BN-2

(5E-5) 12 December 1964, with pickaback Satellite Oscar 2

**Vehicle:** Thor-Able-Star (two stage)

**Orbit:** (5E-1) Apogee 1128.5 km (609 nmi), perigee 1078.4 km (582 nmi), inclination 89.9°

(5E-2) Failed to orbit

(5E-3) Apogee 1108 km (598 nmi), perigee 1078.4 km, inclination 90.0°

(5E-5) Apogee 1078.4 km, perigee 1034 km (558 nmi), inclination 90.0°

**Remarks:** All satellite orbital parameters were close to nominal.

Background

The 5E-series of satellites was designed and fabricated to make scientific measurements on the environment and to flight test engineering improvements and new technology for the Transit navigation satellite system.

Physical Characteristics (Fig. III-3)

*Satellites 5E-1, -2, and -3:*

**Body:** Octagonal prism, 45.72 cm (18 in.) across by 25.4 cm (10 in.) high

Solar Blades (4): 121.92 cm (48 in.) by 25.4 cm, each with 45.72 cm appendage except for Satellite 5E-2 (Fig. III-4)

Weight: (5E-1) 58.58 kg (130.18 lb)

(5E-2) 69.7 kg (154.9 lb)

(5E-3) 52.20 kg (116 lb).

*Satellite 5E-5 (Fig. III-5):*

Body: Octagonal prism, 91.44 cm (36 in.) by 45.72 cm (18 in.)

Solar Cells: Four 36.83 cm (14.5 in.) by 30.48 cm (12 in.) solar boxes plus four 20.32 cm (8 in.) by 12.70 cm (5 in.) panels and four 35.56 cm (14 in.) by 12.70 cm panels mounted on body

Weight: 77.40 kg (172 lb).

### Features

*Satellite 5E-1 (Fig. III-6):*

One oven-controlled oscillator (5 parts in  $10^{11}$ )

Transmitters: 136 (TM), 162, and 324 MHz

Omnidirectional particle detectors (3)

Electron spectrometer

Proton spectrometer

Solar cell experiments

Thermal coating experiment

Transistor circuit reliability experiment

Three axis solar attitude detector

Three axis fluxgate magnetometer

Command system: Eight on/off commands

Telemetry: Two 35-channel commutators with some sub-commutation of analog information plus 256-bit digital encoder

Whip and dipole antenna system.

*Satellite 5E-2 (Fig. III-7):*

Two oven-controlled oscillators

Transmitters: 136 (TM), 162, and 324 MHz

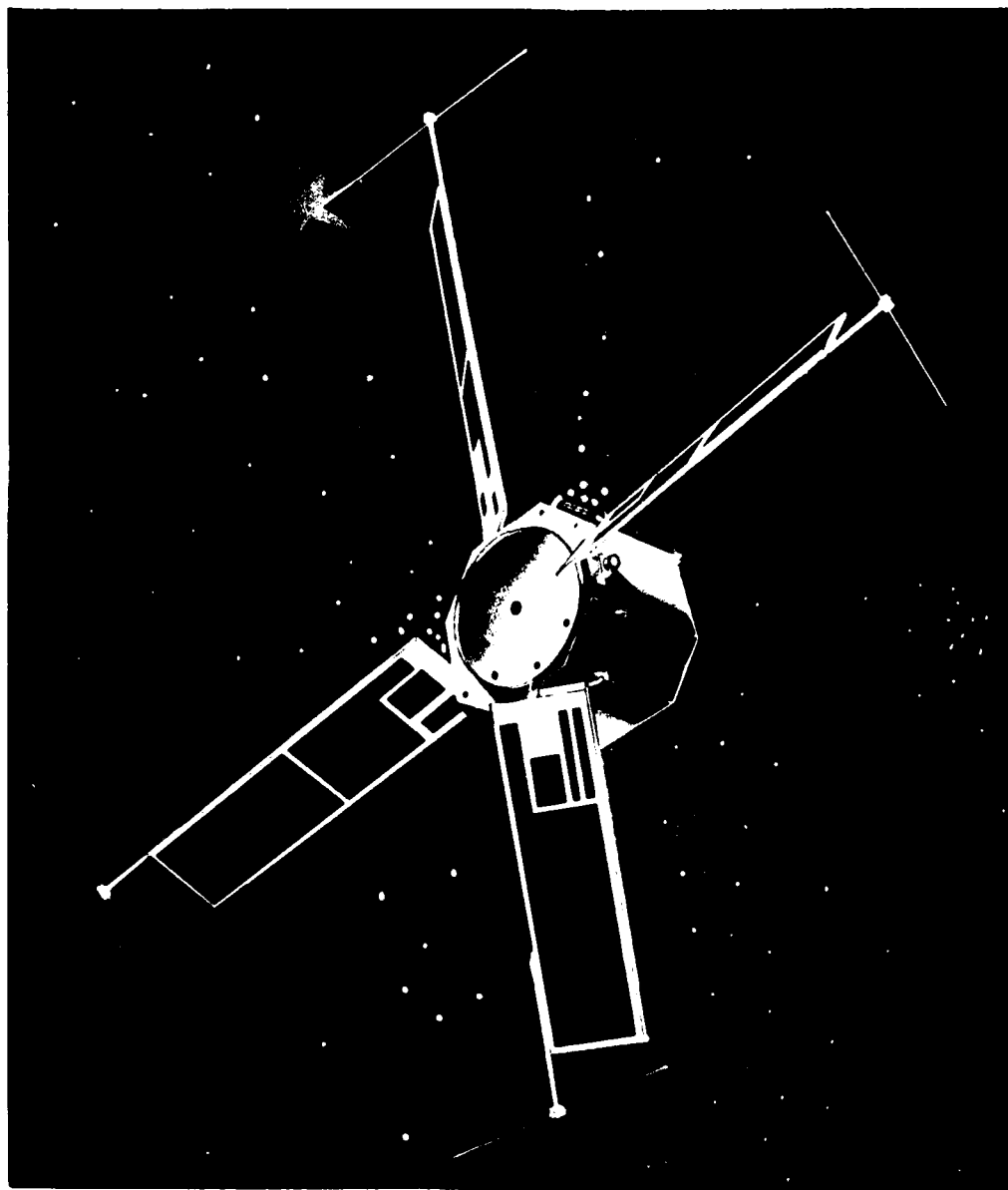

Fig. III-4 Satellite 5E-3, Artist's Concept



Fig. III-5 Satellite 5E-5, Artist's Concept

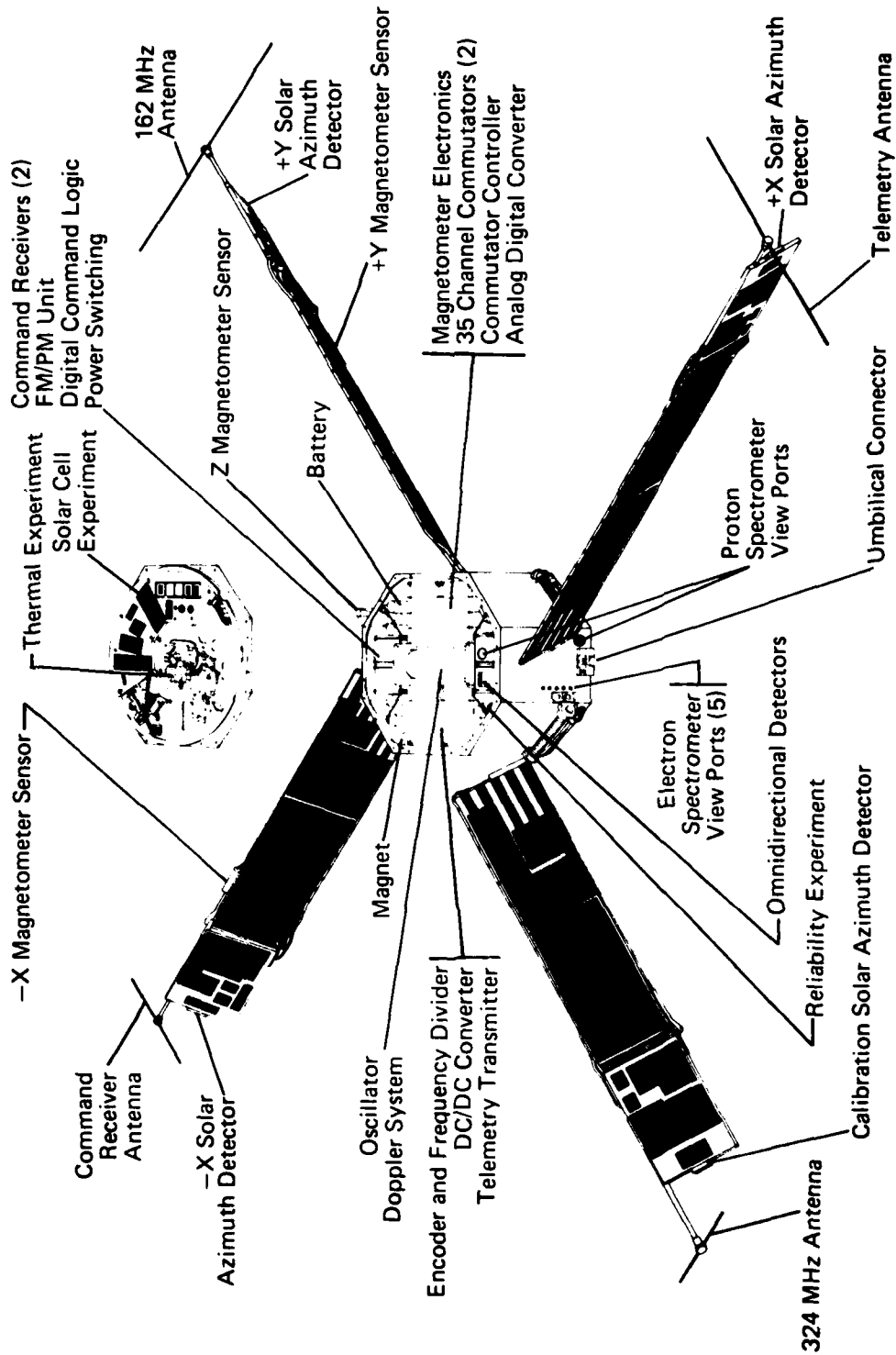

Fig. III-6 Satellite 5E-1, Cutaway View

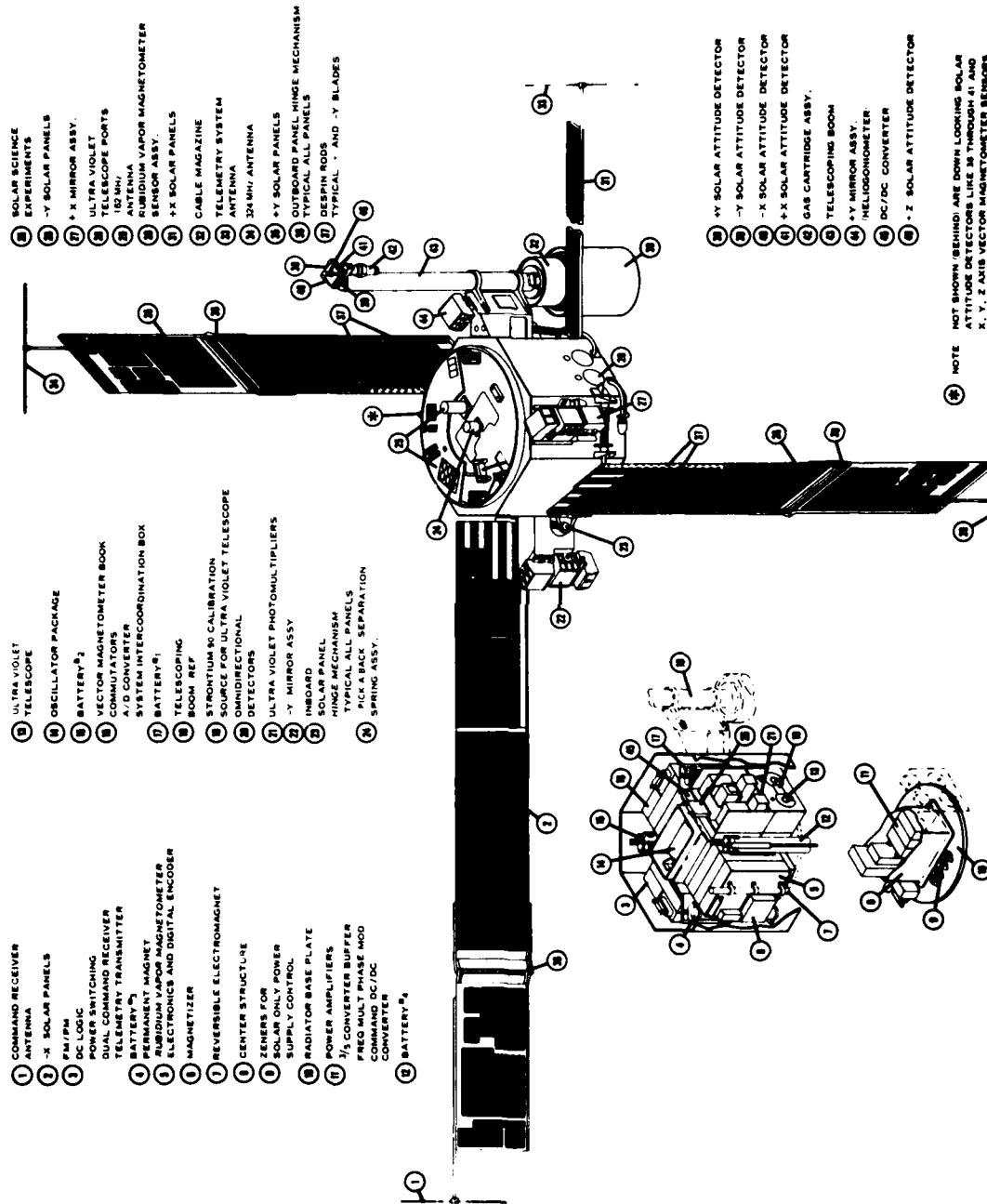

Fig. III-7 Satellite 5E-2, Cutaway View

Solar cell experiments  
Transistor reliability experiment  
360° solid angle heliognoniometer (digital solar attitude sensing system)  
Three axis analog solar detection  
Rubidium vapor magnetometer  
Three axis fluxgate magnetometer  
Ultraviolet telescopes (2)  
Omnidirectional particle detectors (2)  
Power: Solar cells/Ni-Cd batteries (tapped)  
Command system: Eight on/off commands  
Telemetry system: Two 35 channel commutators with some subcommutation of analog information plus 256-bit digital encoder  
Whip and dipole antenna system.

*Satellite 5E-3:*

Two oven-controlled oscillators (9 parts in  $10^{11}$  and 7 parts in  $10^{11}$ )  
Transmitters: 54, 162, 324, and 648 MHz  
Transistor beta experiment  
Transistor leakage experiment  
Magnetic stabilization system  
Power system: Solar cells Ni-Cd batteries and DC/DC converter  
Solar charge limiter  
Automatic temperature control  
Command system: 48 possible operating modes  
Telemetry system: 35 channel reed relay commutator and 35 channel solid state commutator \*  
Whip and dipole antenna system.

---

\* Reed relay telemetry to modulate 162 MHz signal with solid state readout every eighth frame.

*Satellite 5E-5 (Fig. III-8):*

Two stable oscillators (8 parts in  $10^{11}$  and 7 parts in  $10^{11}$ )  
Transmitters: 136 (TM), 162, and 324 MHz  
Power: Solar cells/Ni-Cd batteries with DC/DC converter  
Analog solar attitude detection (three axis)  
Rubidium vapor magnetometer system  
Fluxgate magnetometer system (three axis)  
Ultraviolet telescope (2)  
Omnidirectional particle detectors  
Telemetry: Three 35 channel commutators with some sub-  
commutation of analog data and a 256-bit digital encoder  
Command system: Eight on/off commands  
Metallic sublimation experiment  
Whip antenna system.

Objectives

A primary objective of all 5E satellites was to demonstrate satisfactory operation of the satellite equipment during launch and in orbit. Following are the specific objectives:

*Satellite 5E-1:*

1. Measure omnidirectional flux of protons and electrons above certain threshold energies in order to determine the temporal variations in the radiation environment.
2. Verify information pertinent to radiation effects on various transistors.
3. Determine the effectiveness of seven selected thermal coatings.
4. Determine the effectiveness of protective coatings on solar cells in preventing degradation due to radiation.
5. Backup Satellite 5BN-1 Objective No. 6 (to increase knowledge of the earth's shape and gravitational field).

*Satellite 5E-2:*

1. Map, to a high accuracy, the earth's magnetic field at orbital altitude.



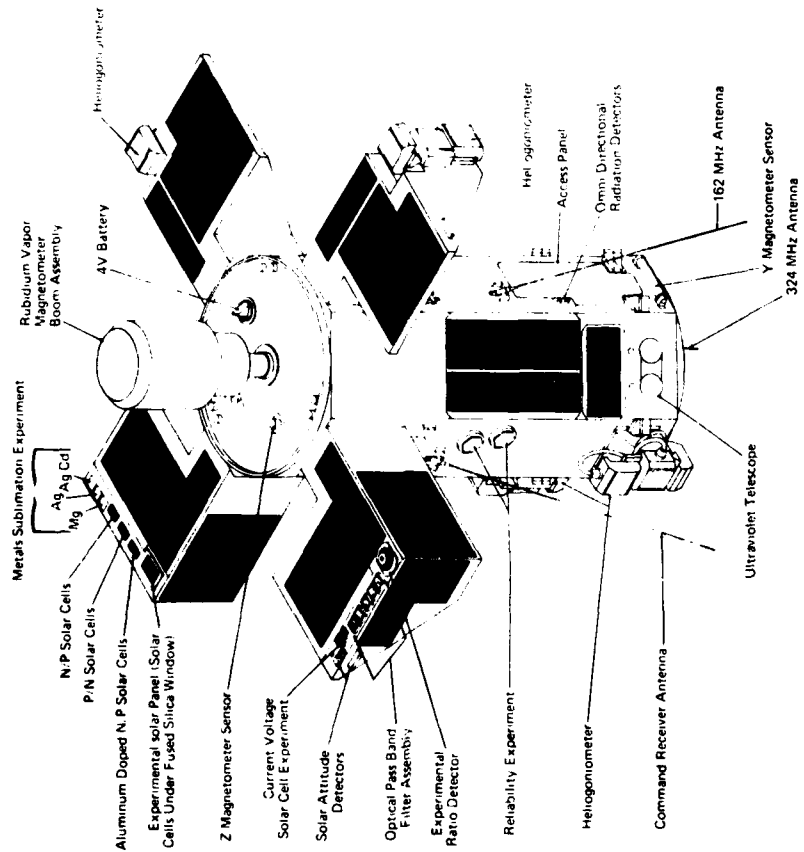
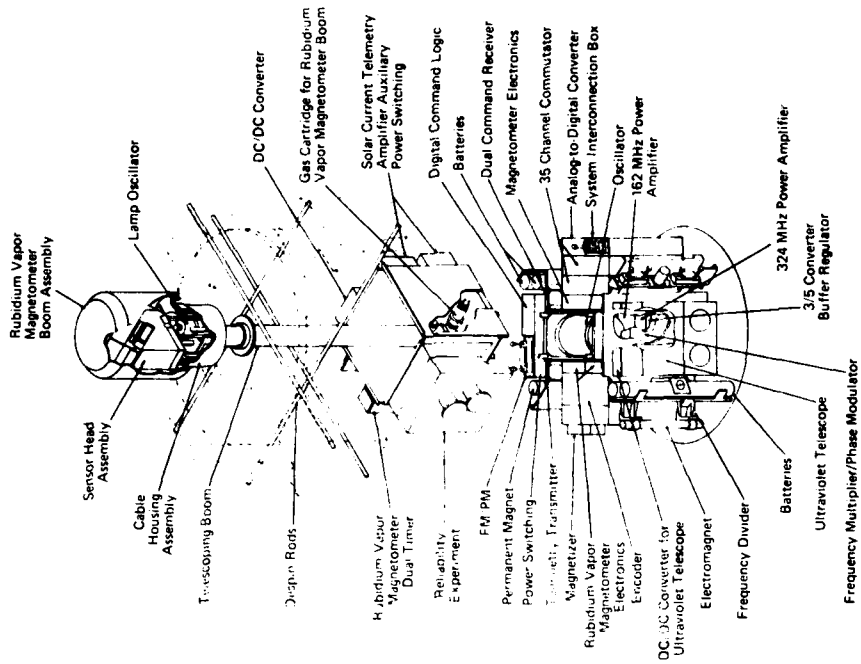

Fig. III-8 Satellite 5E-5

2. Map the celestial sphere in the ultraviolet region.
3. Demonstrate satisfactory operation of a new digital solar attitude detection system.
4. Determine sublimation rates of cadmium, magnesium, and silver-plated cadmium.

*Satellite 5E-3:*

1. Evaluate the effect on the operational system of refraction on radio signal propagation.
2. Test an experimental solid-state telemetry commutator.
3. Obtain flight test experience of battery-charge control by current limiting, since charge control circuitry was intended for use in future satellites.

*Satellite 5E-5:*

1. Map, to a high degree of accuracy, the earth's magnetic field at orbital altitude.
2. Map the celestial sphere in the ultraviolet region.
3. Demonstrate satisfactory operation of a new digital solar attitude detection system.
4. Determine sublimation rates of selected metals.
5. Continue solar spectrum studies from orbit.
6. Determine the reliability of various selected transistors and capacitors in orbit.

Achievements

*Satellite 5E-1:*

All 5E-1 launch objectives were met, and the satellite continues to yield excellent data on high-energy particles. Studies thus far completed include:

1. Measurement of artificial radiation belt decay.
2. Time variations, lifetimes, and response times to magnetic activity of outer zone electrons.
3. Day-night distortion of outer radiation belts.
4. Loss of particles in the South Atlantic anomaly and their subsequent replenishment at longitudes removed from the anomaly.

5. The determination of a nightside magnetospheric configuration based on the observations of trapped electrons in the outer zone.
6. The finding of a 27-day cycle (the solar rotation period) in the trapped electron intensities in the outer zone.
7. Initial results giving behavior of outer zone electrons during magnetically active periods.
8. Tentative understanding of behavior of energetic electrons in outer zone during magnetically quiet periods.
9. Study of the effects of a solar high-energy proton event as seen throughout the magnetosphere.

The solar science experiments have contributed materially to numerous studies concerned with the solar spectrum and long and short term variations in solar intensity. Solar data have facilitated development and calibration of solar simulators and have aided in the development of improved solar cell protection devices.

The transistor reliability study included accurate measurements on the effect of radiation on the performance of selected transistors in orbit, and also provided degradation data that were in excellent agreement with theoretical predictions of the electron density which would produce the observed degradation. The measurements also complemented data received from the electron spectrometer experiment.

Satellite 5E-1 fluxgate magnetometer data were used in the detection of one component of transverse hydromagnetic waves. The studies thus far have shown that: (1) the waves appear primarily in the auroral regions; (2) the magnitudes vary between 25 gamma (the lower limit of fluxgate sensitivity) to about 400 gamma, representing about one percent of the main field at the satellite altitude (1 gamma =  $10^{-5}$  gauss); and (3) more than 100 disturbances have been found.

Satellite 5E-1 provided excellent geodetic data; the satellite longevity resulted in the fulfillment of Objective No. 5.

The 162 MHz transmitter failed on 19 March 1964 and the resultant load change has since allowed only limited operation in battery mode. However, the major satellite experiments were not seriously affected.

Satellite 5E-1 has become one of the most productive satellites ever launched. Data were acquired routinely for over six years and the satellite has functioned for a full solar cycle (11 years). A bibliography of the published papers (Table C-2) based on data from the 5E satellites is included in Appendix C.

*Satellite 5E-2:*

This satellite failed to orbit and no useful data were obtained. Prior to reentry, Satellite 5BN-3 separated from 5E-2 and the 5E-2 solar blades deployed normally. Satellite 5E-2 systems operation prior to reentry was normal.

*Satellite 5E-3:*

Objective No. 4 was partially achieved in that charge control design information gained aboard 5E-3 was used to improve charge control circuitry in future navigation satellites. However, improper charge control circuit operation aboard 5E-3 permitted only partial realization of Objective No. 1 and ultimately precluded attainment of Objective No. 2. Objective No. 3 was met.

The charge control circuit malfunction demanded continuous adjustment of satellite loads to avoid the development of serious thermal troubles as well as to determine the inter-relationship of the parameters which assisted in the analysis of the problem. Because of this continual adjustment, good four-frequency data which are mandatory for proper ionospheric research were not obtained over extended periods of time.

The experimental solid state commutator performed perfectly, and was the prototype for those used in subsequent APL satellites.

5E-3 transmissions were last received 19 July 1964.

*Satellite 5E-5:*

All satellite 5E-5 launch objectives were met.

The rubidium vapor magnetometer sensing head mounted on a 16-foot telescoping boom was extended on command on 15 December 1964. This boom separated the sensing head from the magnetic field of the satellite body so that the ultrasensitive scalar magnetometer received minimum artificial bias. The 5E-5 scalar magnetometer system was complemented by a three axis fluxgate vector magnetometer system.

After a period of erratic behavior, the rubidium vapor magnetometer gave useful data in middle and low latitudes during the period of 17 April to 8 June 1965, when sunlight illuminated the entire satellite orbit. These data as well as the values obtained in the last two weeks of December 1964 were compared and the results computed using the existing theoretical model. Residuals in this comparison were used to determine an improved set of harmonic coefficients.

The ultraviolet telescope furnished excellent data until June 1965. The identification of ultraviolet sources was dependent on the reduction of the vector magnetometer and the heliogoniometer system data as well as the satellite position information derived through doppler tracking. The heliogoniometer system located the satellite sun line to within one-tenth of a degree. In-flight calibrations accomplished both by a stellar source and an artificial source included in the photometer package established that the photometer sensitivity remained constant for the three months following launch.

"Results from the 5-E Series of Satellites," a symposium on the occasion of the 11th anniversary of the 5E-1 satellite, was held at APL/JHU on 27 September 1974 with representatives of NASA, NOAA, and APL in attendance. The symposium included reviews summarizing the principal scientific and engineering results obtained from data collected with the 5E satellites, and Satellite 5E-1 in particular.

THE JOHNS HOPKINS UNIVERSITY  
APPLIED PHYSICS LABORATORY  
LAUREL MARYLAND

SDO 1600  
May 1975

DODGE SATELLITE  
(1967 66F)

III-23

THIS PAGE BLANK-NOT FILMED

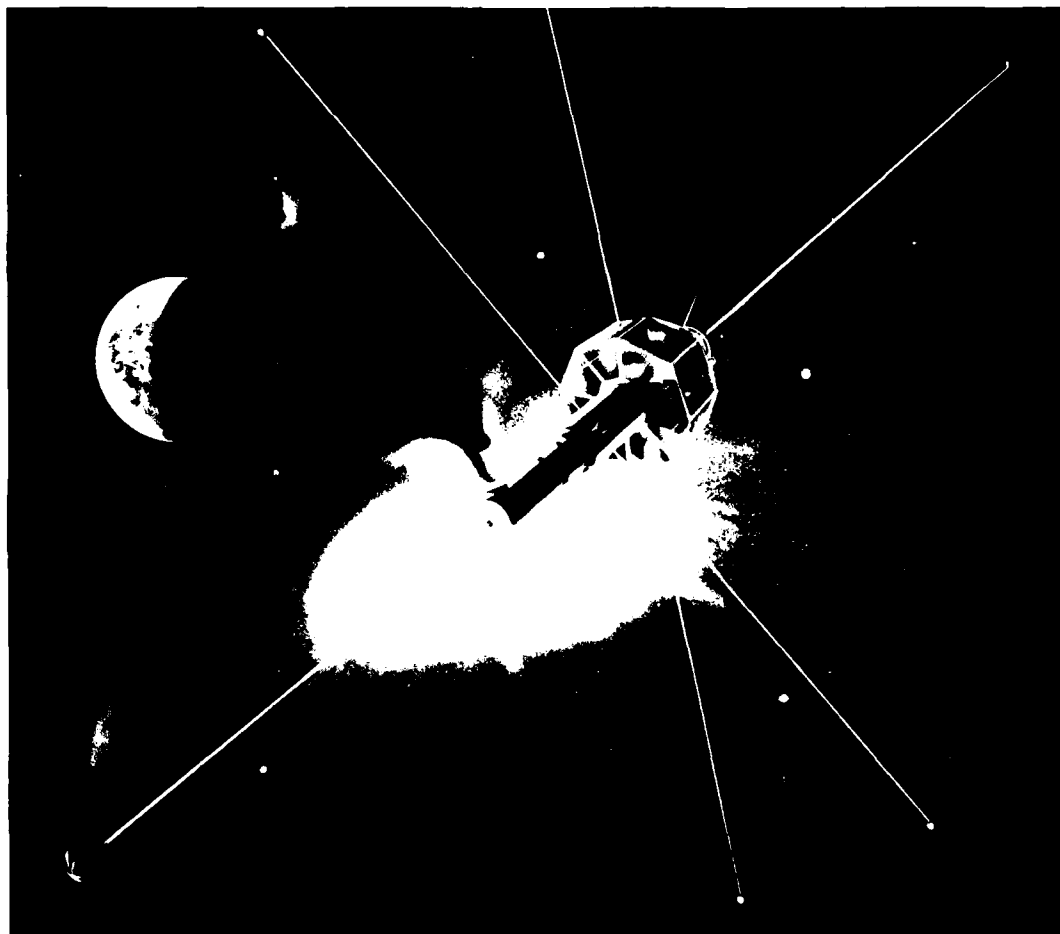

Fig. III-9 DODGE Satellite, Artist's Concept

DODGE SATELLITE

Launch: 1 July 1967, Kennedy Space Center, Florida  
Vehicle: Titan III-C (SSLV No. 14)  
Orbit: Apogee 33,652 km (18,161 nmi), perigee 33,278 km  
(17,959 nmi), inclination 5.2°  
Remarks: Launched with five other satellites - three  
communications satellites (Program 572),  
LES 5 (Lincoln Experimental Satellite) and  
DATS (Despun Antenna Test Satellite).

Background

The DODGE (Department of Defense Gravity Experiment) Satellite Program was designed primarily to expand the relatively new technology of gravity gradient satellite stabilization to the higher near-synchronous altitudes, and support development of more reliable passive gravity gradient attitude controls for earth satellites generally.

Physical Characteristics (Fig. III-9)

Body: Truncated octagon, 111.9 cm (48 in.) across flats by 134.6 cm (53 in.) across corners by 82.8 cm (32.6 in.) high  
Stack: In two sections: Gimbal Damper Housing, 68.07 cm (26.8 in.) by 41.9 cm (16.5 in.) cylinder and Flux-gate Magnetometer Support Section, 89.6 cm (35.28 in.) by 32.7 cm (12.875 in.) - total stack length, 157.7 cm (62.09 in.)  
Solar Cells: Body mounted (Fig. III-10)  
Weight: 193.3 kg (429.5 lb); attach hardware, 4.2 kg (9.3 lb).

Features

Two oven-controlled oscillators (3 parts in  $10^{12}$  and 2.75 parts in  $10^{12}$ )\*  
Transmitters: 136.8 MHz (10 watt) and 240 MHz (8 watt)

---

\* Five second averaging time.



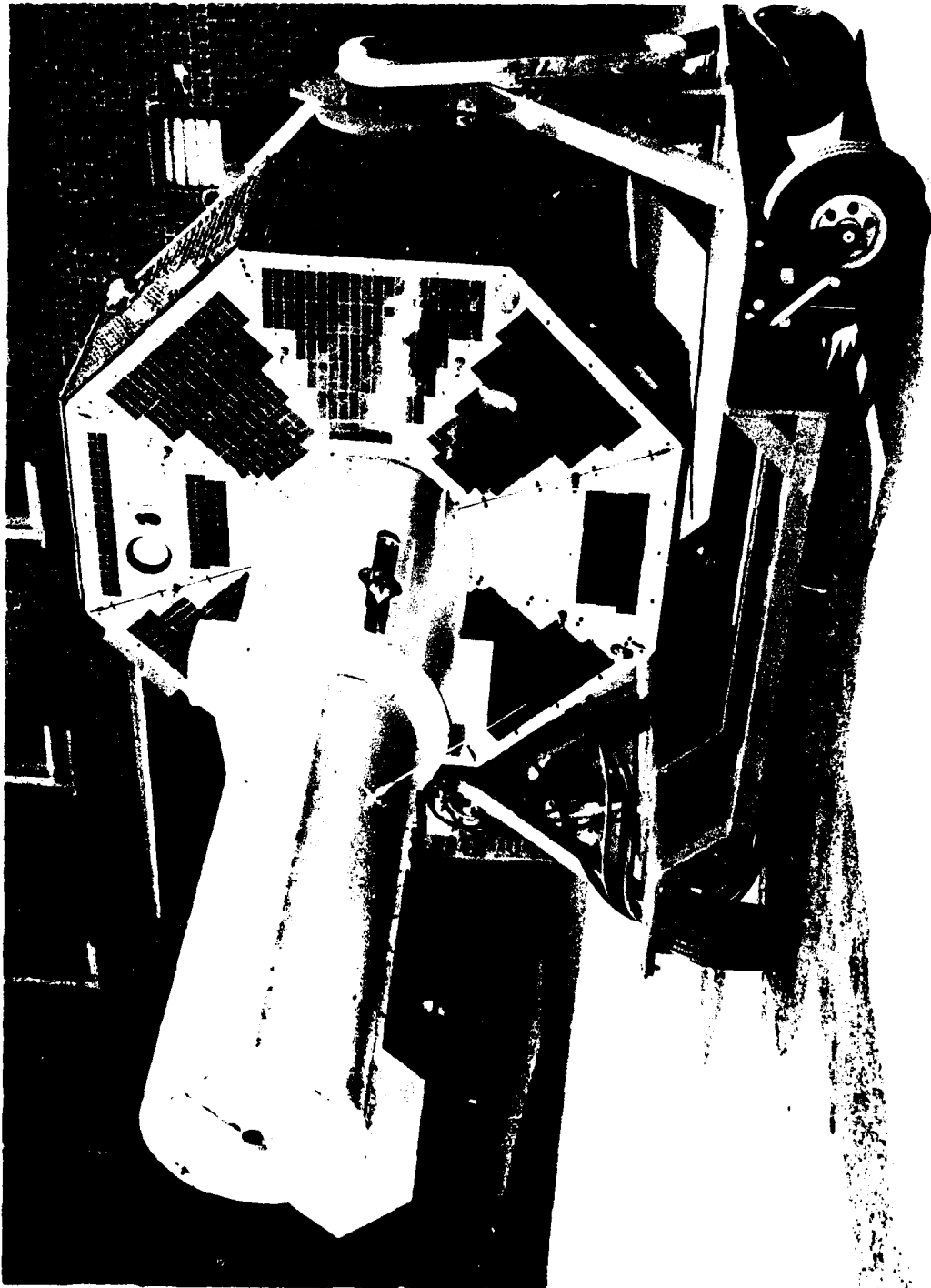

Fig. III-10 DODGE Satellite During Sunlight Tests

**Power:** Solar cells/Ni-Cd batteries with battery temperature control, a low voltage sensing switch, a redundant main power converter, a standby power converter, a TV system converter, and a command system converter

**Magnetic stabilization**

**Gravity gradient stabilization**

**Attitude Control Systems:** (1) Magnetic stabilization system consisting of a three-axis vector magnetometer, two variable X and Y axes electromagnets, and one torquing coil perpendicular to Z axis; (2) Gravity gradient stabilization system consisting of eight motorized extendable and retractable booms; (3) Combined gravity gradient and flywheel control systems consisting of Z-axis booms and a flywheel motor; (4) Combined gravity gradient and magnetic stabilization systems consisting of Z-axis booms and magnetic system; and (5) A torsion wire damper system consisting of two motorized extendable and retractable booms on torsion wire suspension, an Eddy-current damper, a hysteresis damper, and an angle detection device; (6) Magnet hysteresis damping system consisting of the three-axis vector magnetometer of the first system, a hysteresis generator, and a three channel DC power amplifier; (7) Time lag magnetic damping system consisting of the magnetometer and electromagnets of the first system and a time lag generator; and (8) Viscous damping of Z Booms which included silicone fluid in the end mass of each Z axis boom

**Attitude Sensing Systems:** (1) Dual TV camera system consisting of a 60° field-of-view black and white camera and a 22° field-of-view black and white, and color TV (frame time 200 seconds, lens speed f/2.5, and using a Vidicon image tube); (2) Analog sun sensors; and (3) Three-axis vector magnetometer

**Experiments:** (1) Two-axis gravity gradient experiment, (2) Three-axis gravity gradient attitude control experiment, (3) Various damping systems, (4) Color TV system, and (5) Solar cell experiment

**Telemetry:** Two 38-channel commutators for attitude data, one 76-channel commutator for data on housekeeping functions, and six 15-bit telltale registers (either or both transmitters selectable)

**Command System:** Dual command receiver, dual command logic, and power switching circuitry, providing 64 two-state commands

**Antennas:** Phased whip pair (136 MHz) and turnstile (240 MHz).

### Objectives

The primary objectives of the DODGE satellite program were as follows:

1. To provide a passive, three-axis attitude control system at near-synchronous altitude using the earth's gravity field.
2. To provide accurate vertical stabilization ( $\pm 2^\circ$ ) yaw stabilization ( $\pm 4^\circ$ ) with rapid damping; for direct application to DoD communication, meteorological, and surveillance satellite programs.
3. To provide an experimental confirmation of analytical study results obtained for gravity gradient stabilized satellites. Data from this objective will provide fundamental constants which can be used in the design of future gravity gradient attitude controlled satellites.

Following are the secondary objectives:

1. To study boom bending characteristics induced by solar radiation heating.
2. To measure the earth's magnetic field at near-synchronous altitude.
3. To measure the output of different types of solar cells.
4. To explore the utility of color television in earth observation from near-synchronous altitude.

### Achievements

Summarized below are the most significant conclusions and accomplishments of the DODGE satellite experiment.

1. Two-axis and three-axis gravity gradient stabilization is achievable at synchronous altitude.
2. Three-axis stabilization can be achieved with the use of multiple booms, and improved yaw stabilization can be achieved with the use of booms plus an angular momentum flywheel.
3. Computer simulations which can predict the motions of gravity stabilized satellites were developed.

4. The magnetometer system on board the satellite had a systematic error caused by some interaction with the spacecraft. This interaction was influenced by the attitude of the spacecraft relative to the sun. In spite of this deficiency, the magnetic sample-hold damping system proved to be an effective means for removing satellite libration.
5. With the DODGE magnetic sample and hold system, the best stabilization achieved was about  $2^{\circ}$  r/sec in pitch,  $2.5^{\circ}$  r/sec in roll, and  $10^{\circ}$  r/sec in yaw. However, this condition was not maintained for any considerable length of time. With the flywheel off, disturbances in attitude were usually initiated by large disturbances in yaw. With the flywheel on, yaw stability was distinctly improved and never became unstable.
6. The satellite showed improved stabilization when the sun line was contained in the orbit plane. This was undoubtedly a result of a lower level of solar radiation pressure disturbance.
7. Measurements of boom bending confirmed that the magnitude of the bending as theoretically calculated was close to being correct, however a small hysteresis effect in boom bending was observed that was not considered by any prior investigators. A lack of straightness was observed in the one boom on which this measurement could be made. Although the boom was the straightest available within the existing state-of-the-art and was within design specifications, it still deviated by  $1.2^{\circ}$  from being straight. The combined effects of lack of straightness, hysteresis in boom bending, and the boom bending itself were probably the reasons why the DODGE satellite did not more accurately achieve three-axis gravity gradient stabilization. These deviations from the theoretical model of boom bending also account for the fact that computer prediction of satellite attitude was accurate in magnitude over many days, but after more than 1.5 days a phase discrepancy in the attitude motions was usually observed.
8. The torsion wire damper boom system was not effective in damping satellite oscillation. This was possibly due to the fact that there was an appreciable angular bias from the rest position of the damper boom.

Listed below are several conclusions regarding the technological aspects of the DODGE satellite which are significant:

1. Extendable boom units using 400 Hz, AC, hysteresis synchronous motors are exceedingly reliable for repeated operations in the space environment. A total of more than 200 such operations on individual booms were performed in the first year of satellite operation.
2. Television cameras are an excellent means for attitude determination.
3. Color photography of the earth using color filters was shown to be practical and reliable (Fig. III-11). The first, full-disc, color photograph of the earth was taken on 25 July 1967 from the DODGE satellite.
4. The DODGE telemetry system, in which the RF power and information bandwidth could be altered, the transmitted frequency could be changed, and the directional or omnidirectional antenna could be selected, proved to be exceedingly valuable and would be useful if adapted to other experimental satellites.

In summary, the DODGE satellite achieved its primary objective of obtaining gravity gradient stabilization at near-synchronous altitude. Usually the attitude alignment was poorer than desired, undoubtedly due to some unknown interaction between the satellite and its magnetometers. In the case of the torsion wire damper, the lack of damping was probably due to an angular bias offset.

On DODGE it was not possible to place the magnetometer sensors as far from the satellite body as desired. With more optimum sensor placement on another spacecraft, particularly a satellite with a single boom, "dumbbell" configuration and an angular momentum flywheel for yaw control, one could expect that accuracies of better than  $1^\circ$  peak angle each in roll, pitch, and yaw could be achieved at synchronous altitude.

Table C-3 (Appendix C) contains a bibliography on the DODGE satellite.

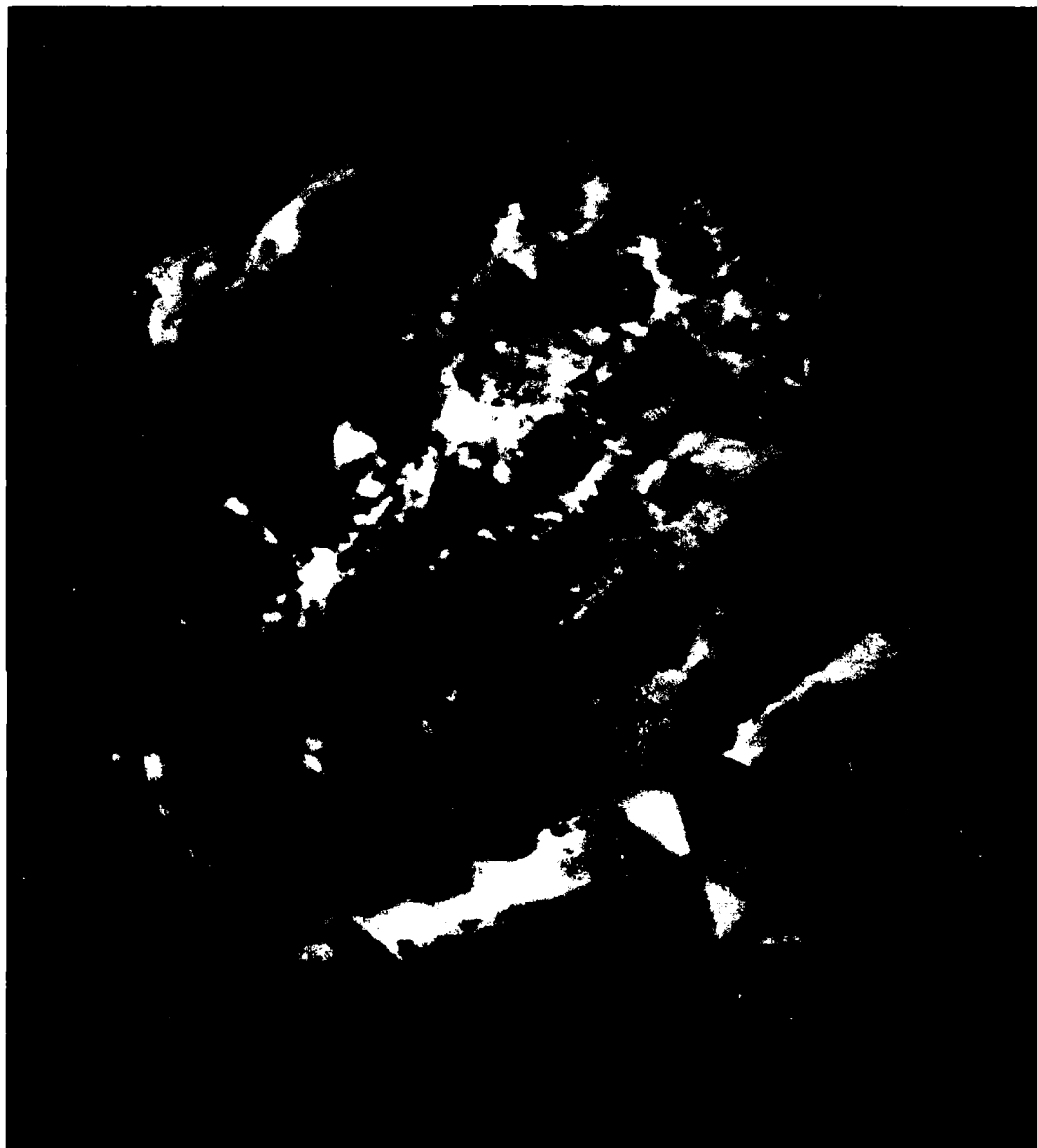

**Fig. III-11 Earth as Photographed from DODGE Satellite on 23 September 1968**

BEACON EXPLORER SATELLITES

BE-A

BE-A  
(1964 64A)

BE-C  
(1965 32A)

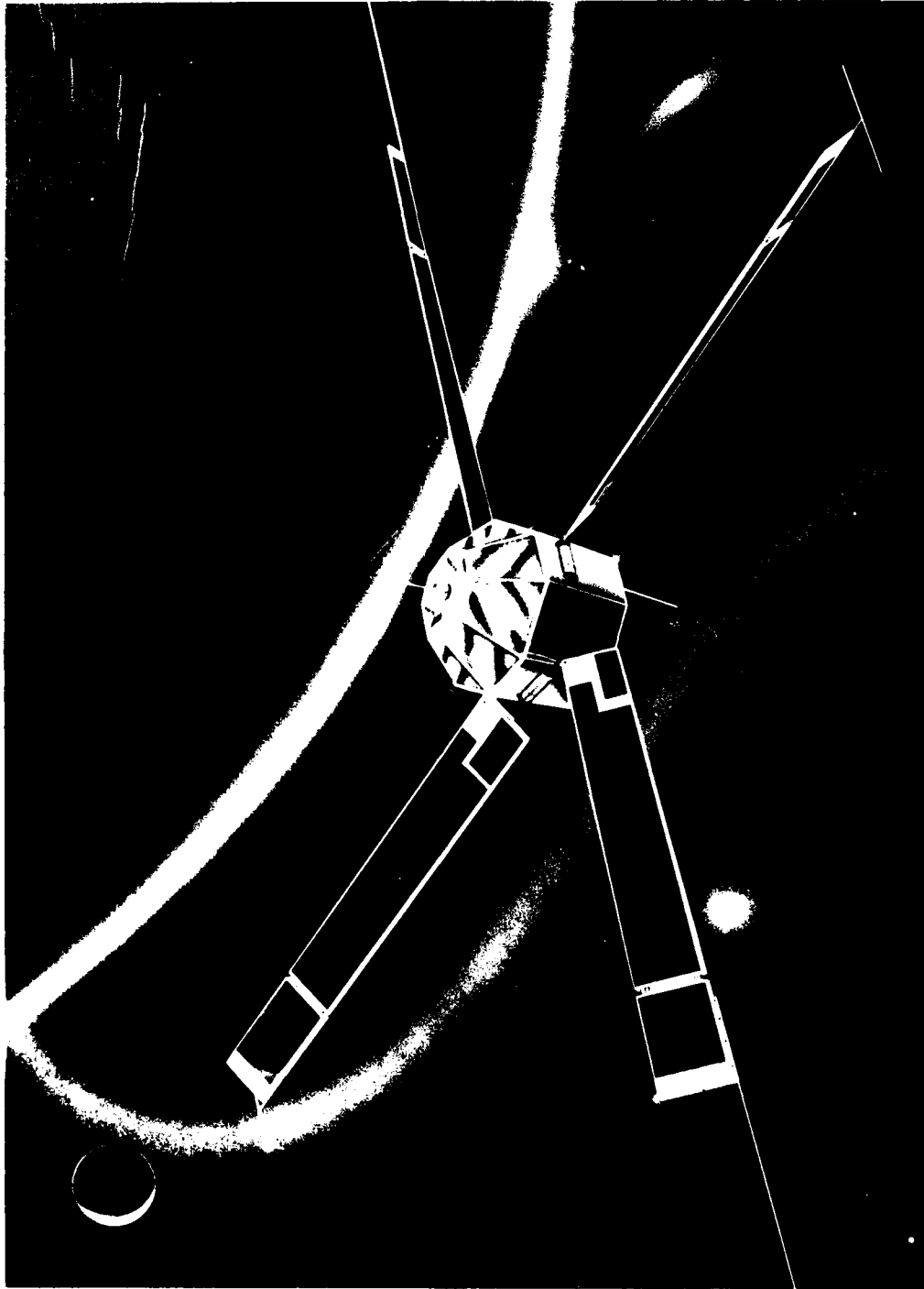

Fig. IV-1 BE-A Satellite, Artist's Concept



BEACON EXPLORER SATELLITES

Launch: (BE-A) 19 March 1964; Kennedy Space Center, Florida  
(BE-B) 9 October 1964; Vandenberg AFB, California  
(BE-C) 29 April 1965; Wallops Flight Center, Virginia

Vehicle: Thor Delta (three stage) - BE-A only; the Scout (four stage) was used to launch BE-B and BE-C.

Orbit: (BE-A) Failed to achieve orbit  
(BE-B) Apogee 1085.8 km (586 nmi), perigee 891.3 km (481 nmi), inclination 79.7°  
(BE-C) Apogee 1356.4 km (732 nmi), perigee 937.6 km (506 nmi), inclination 41.0°

Remarks: BE-A failed to orbit due to a third stage vehicle failure. Despin, solar blade deployment, and separation were normal for BE-B and BE-C.

Background

Radio beacons and direct measuring electron density probes are the principal instruments for collecting data on the ionosphere; satellites of the Beacon Explorer (BE) series (BE-A, -B, and -C) were well equipped with both. A laser reflector consisting of 160 quartz corner reflectors was mounted on the top of each spacecraft so that the north-seeking end of the satellite magnet would be oriented toward earth as the spacecraft passed over the northern hemisphere. Electron density probes protruded from the center structure and baseplate of the laser retroreflector so that they were oriented oppositely and parallel to the spacecraft Z axis. Scientists from 37 countries with a total of 102 tracking stations participated in worldwide ionospheric structure studies under NASA direction using the broad range of BE-B (Explorer 22) and BE-C (Explorer 27) frequencies.

Physical Characteristics (Fig. IV-1)

Body: Octagonal prism, 45.72 cm (18 in.) by 25.4 cm (10 in.) high

Solar Blades (4): 121.92 cm (48 in.) by 25.4 cm, each with a 45.72 cm by 25.4 cm hinged appendage

Weight: (BE-A) 52.5 kg (116.6 lb); 4.5 kg (10 lb) attach hardware  
(BE-B) 52.2 kg (116.0 lb); 5.8 kg (13 lb) attach hardware  
(BE-C) 54.0 kg (120.0 lb); 6.7 kg (15 lb) attach hardware.

Features (Figs. IV-2 and IV-3)

RMS Oscillator Stability:

(BE-B) 1 part in  $10^{10}$  (3 MHz osc.) and 2 parts in  $10^{10}$  (5 MHz osc.)

(BE-C) 1 part in  $10^{11}$  (5 MHz osc.), 5 parts in  $10^{11}$  (3 MHz) and 6.3 parts in  $10^{11}$  (beacon osc.)

Transmitters: 20, 40, 41, 136 (TM), 162, 324, and 360 MHz

Local electron density probes (2)

Laser reflector (160 quartz corner reflectors)

Power: Solar cells Ni-Cd batteries

Yo-yo despin system

Magnetic stabilization system

Fluxgate magnetometer (three axis)

Solar attitude sensor (three axis)

Laser beam detector (BE-C)

Automatic temperature control

Telemetry: 35 channel PAM commutator, 8 channel PDM subcommutator, and seven telltale register functions on PCM format

Command System: 48 operating modes

Antennas: Whip and dipole system.

Objectives

*BE-A and BE-B:*

1. Provide a means for plotting total configuration of the ionosphere.
2. Determine the total electron content of the ionosphere in a vertical cross section between the spacecraft and the earth under quiet and disturbed conditions; study its diurnal and seasonal variations.

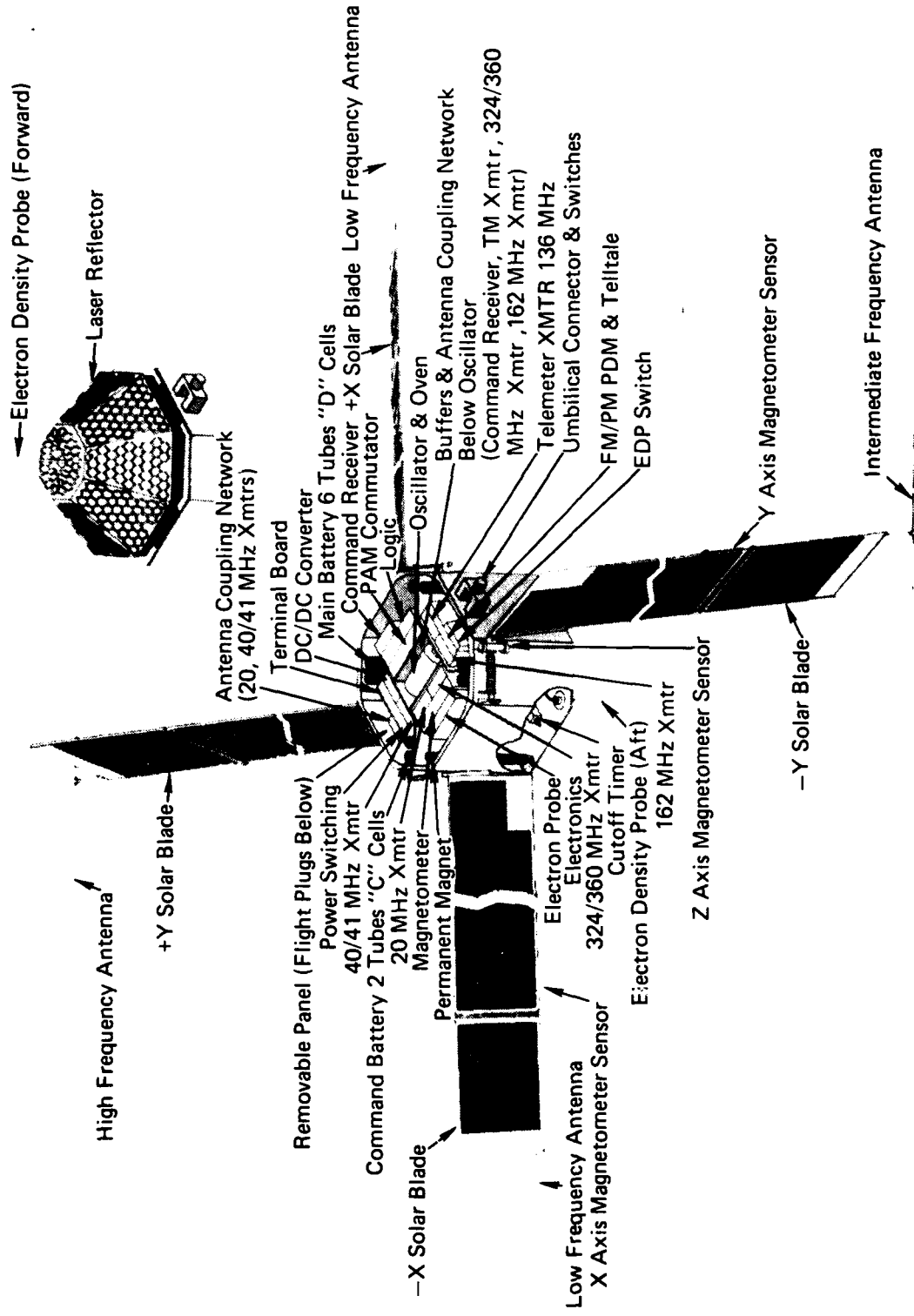

Fig. IV-2 BE-A Satellite, Cutaway View

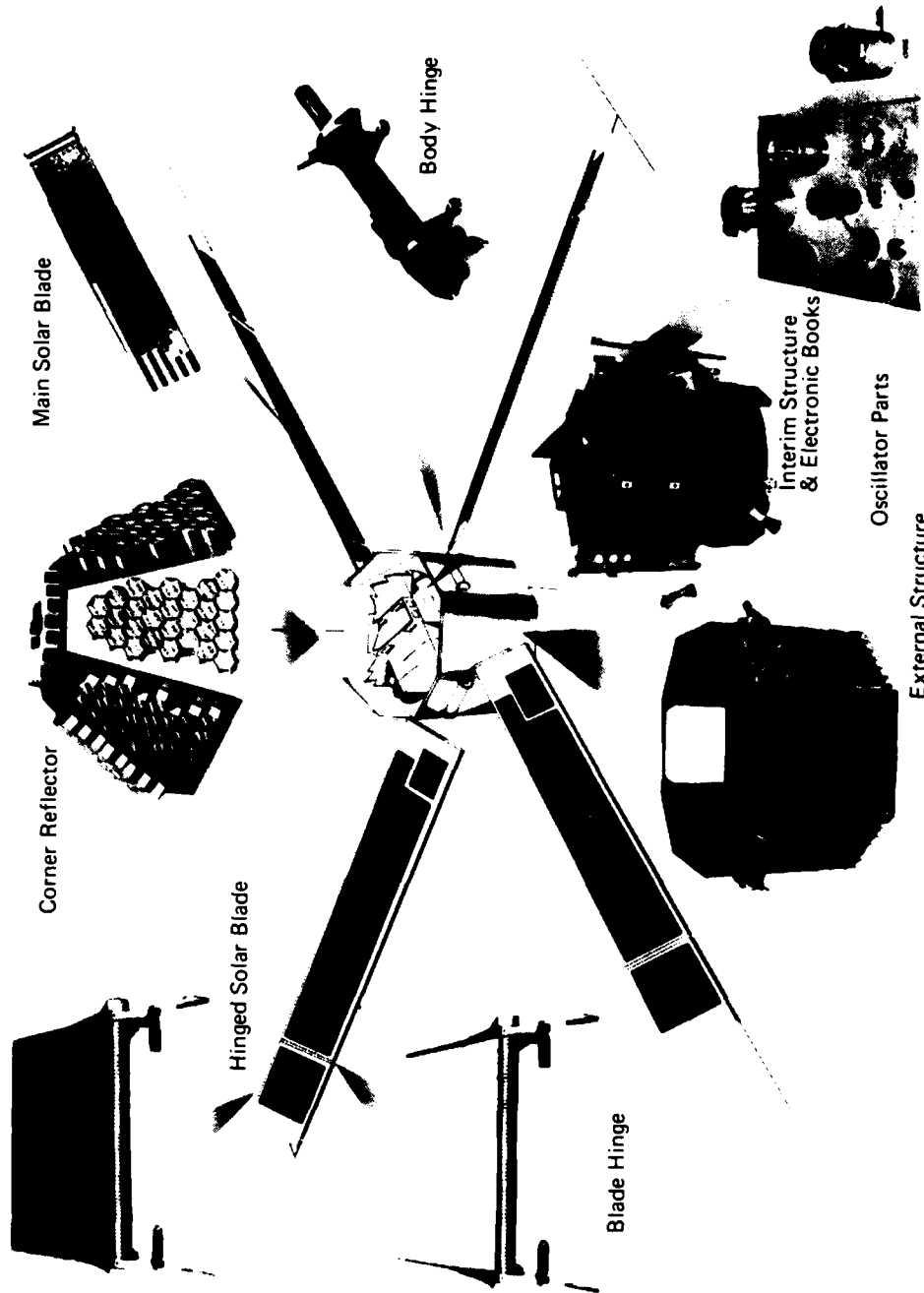

Fig. IV-3 BE-A Satellite, Exploded View

3. Relate the gross behavior of the ionosphere to the solar radiation producing the ionization, and study the effects of solar flares upon the ionosphere.
4. Study the geometry and occurrence of irregularities known to exist in radiowave propagation in the ionosphere.
5. Test the newly devised laser tracking system.

*BE-C:*

1. Study the perturbations in the satellite orbit by means of radio doppler tracking techniques in order to refine knowledge of the earth's gravitational field.
2. Study the earth's ionosphere utilizing Faraday rotation, differential doppler, and closely spaced frequency methods of analysis with a worldwide tracking network.
3. Determine the total electron content of the ionosphere in a vertical cross section between the spacecraft and the earth under quiet and disturbed conditions, and study its diurnal and seasonal variations.
4. Relate the gross behavior of the ionosphere to the solar radiation producing it, and study the effects of solar flares on the ionosphere.
5. Study the geometry and occurrence of irregularities known to exist in radio wave propagation in the ionosphere.
6. Test the recently devised laser tracking system.

Achievements

*BE-A:*

During the burn of the Delta rocket third stage, a malfunction of undetermined origin occurred and BE-A failed to achieve orbit. It reentered the earth's atmosphere over the South Atlantic Ocean and was destroyed. No useful data were obtained.

*BE-B:*

All launch objectives were met by BE-B. Under NASA direction, worldwide ionospheric structure studies were started using the broad range of frequencies transmitted by BE-B. All data received were exchanged through the World Data Center at NASA GSFC.

The BE-B electron density probes furnished comprehensive direct measurements of low energy electron densities at orbital altitude.

*BE-C:*

All BE-C launch objectives were met. A vast amount of data on ionospheric scintillations were secured from both BE-B and BE-C. In addition to the major NASA observation program, the Air Force Cambridge Research Laboratory (AFCRL) carried out a program of scintillation studies and coordinated the efforts of a large network of stations. Some 40 papers based on findings from BE-B and BE-C data were published.

Telemetered responses of the laser detector in the orbiting satellite provided the desired confirmation that laser reflections observed on earth were indeed from the satellite.

The  $41^{\circ}$  inclination of the satellite's orbit was selected to increase geodesy coverage. Since previous APL satellites had provided doppler data from orbital inclinations of  $32^{\circ}$ ,  $50^{\circ}$ ,  $67^{\circ}$ ,  $80^{\circ}$ , and  $90^{\circ}$ , the placement of BE-C midway in the gap between  $32^{\circ}$  and  $50^{\circ}$  was highly desirable.

THE JOHNS HOPKINS UNIVERSITY  
APPLIED PHYSICS LABORATORY  
LAUREL MARYLAND

SDO 1600  
May 1975

DME-A SATELLITE  
(1965 98B)

IV-9

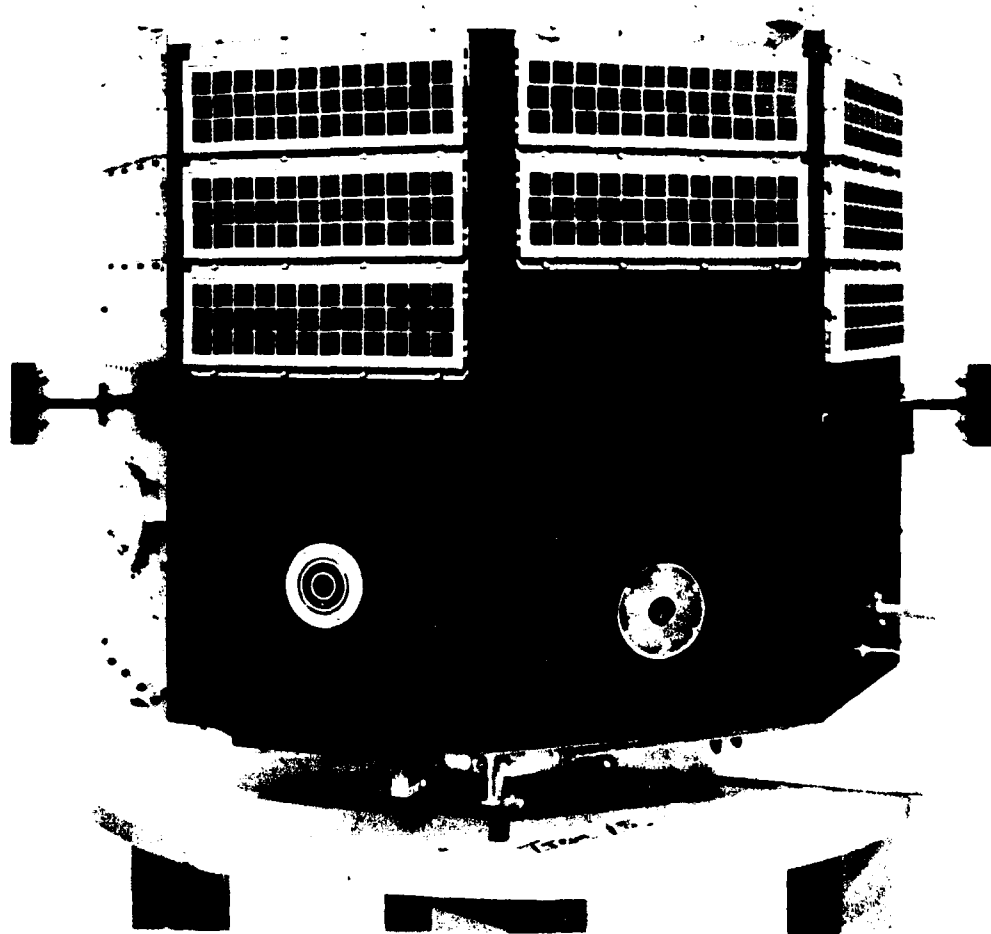

Fig. IV-4 DME-A Satellite



DME-A SATELLITE

Launch: 29 November 1965; Vandenberg AFB, California  
Vehicle: Thor-Agena (two stage)  
Orbit: Apogee 2957.3 km (1596 nmi), perigee 496.6 km  
(268 nmi), inclination 79.8°  
Remarks: Launched with pickaback satellite Alouette-B;  
separation normal.

Background

The DME-A (Direct Measurement Explorer) satellite (Explorer 31) was supplied to GSFC and launched with the Canadian DRTE (Defence Research Telecommunications Establishment) pickaback satellite Alouette-B as part of the ISIS X (International Satellite for Ionospheric Studies) Program. Both satellites were placed in a nominal 80° prograde orbit with a minimum separation distance so that comparable data were obtained from both satellites.

Physical Characteristics (Fig. IV-4)

Body: Octagonal drum, 76.2 cm (30 in.) dia., 63.5 cm (25 in.) high, plus 53.3 (21 in.) long by 2.54 cm (1 in.) dia. spherical ion-mass spectrometer assembly extension  
Solar Cells: Mounted about body, and covering 15% of body area  
Weight: 98.52 kg (218.9 lb).

Features

Transmitter: 136.38 MHz (2 watts)  
Power: Solar cells/Ni-Cd batteries  
Magnetic torquing system for spin axis orientation with magnetic spin rate control  
Passive nutation damper  
Telemetry: PCM/PM and PAM/FM/PM systems operated independently by ground command  
Command System: Control satellite experiments, attitude control system, etc.

Scientific Experiments:

- A<sub>1</sub> Ion Retarding Potential Experiment
- B<sub>1</sub> Electron Retarding Potential Experiment
- B<sub>A</sub> Energetic Electron Current Monitor Experiment
- B<sub>D</sub> Energetic Electron Count Monitor Experiment
- C<sub>1</sub> Electrostatic Probe Experiment
- C<sub>2</sub> Electrostatic Probe Experiment
- D High Resolution Ion Mass Spectrometer
- E U.K. Electron Temperature
- F Spherical Ion Mass Spectrometer.

Objectives (DME-A and Alouette-B)

1. Measure the ionospheric distribution of free electrons and the ion composition so as to permit investigation of diurnal, seasonal, solar cycle, and disturbance-time variations.
2. Measure the composition and fluxes of energetic particles that interact with the ionosphere.
3. Measure velocity distribution of "thermal" electrons and ions in the ionosphere.

Achievements

During ISIS X Program operations, the attitude control system was used to maintain the spin axis orientation, and the magnitude of the spin rate was kept near the desired value of 2 r/min. The normal attitude mode was with the spin axis perpendicular to the orbital plane.

In October 1966, as part of a satellite systems check, the spin rate was increased to 54.5 r/min and decreased back to 6 r/min. During this operation, the spin centrifugal switch was found to actuate at 41.03 r/min and to deactuate between 28.4 r/min and 17.2 r/min. The angular acceleration of the spin system was 1.04 r/min per hour. These values showed excellent correlation with ground test data. With the completion of this test, all DME-A satellite equipment was found to operate properly.

The DME-A satellite easily exceeded its design life of one year and, commencing August 1969, was operated by ESSA (Environmental Sciences Services Administration), Boulder, Colorado. Experiments B<sub>A</sub> and B<sub>D</sub> failed in June 1967, and Experiment D became marginal. Spacecraft operations were suspended in late 1970.

THE JOHNS HOPKINS UNIVERSITY  
APPLIED PHYSICS LABORATORY  
LAUREL MARYLAND

SDO 1600  
February 1978

P76-5 SATELLITE  
(1976 47A)

IV-13

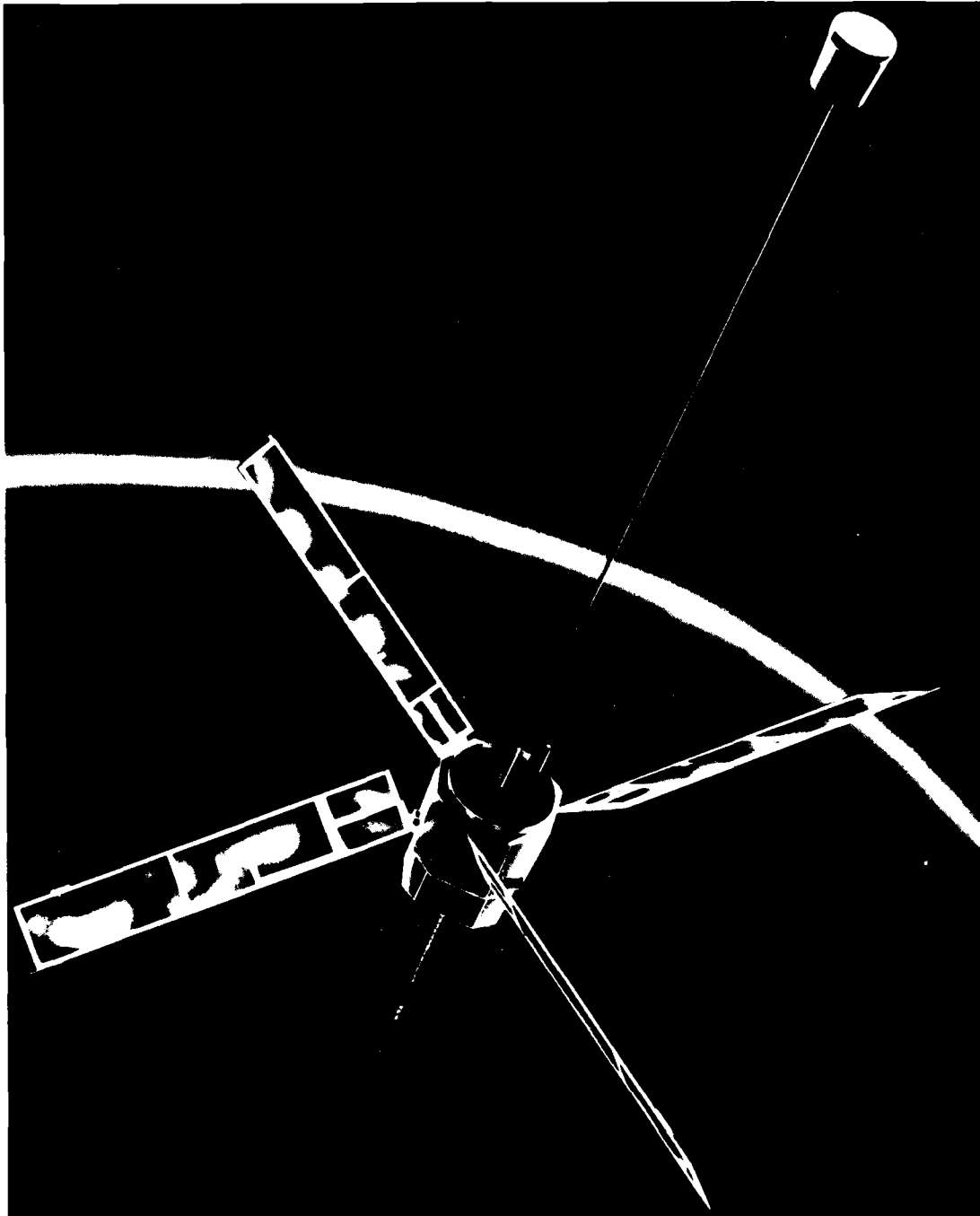

Fig. IV-5 P76-5 Satellite, Artist's Concept

P76-5 SATELLITE

Launch: 22 May 1976; Vandenberg AFB  
Vehicle: Scout B-2 (four stage)  
Orbit: Apogee 1053.6 km, perigee 979.5 km, inclination 99.67°  
Remarks: Despin, solar panel deployment, 4th stage separation, and stabilization normal; orbit achieved was essentially as desired.

Background

The P76-5 (Fig. IV-5) is a modified Transit satellite (Oscar 15) that had been stored as a spare for possible use in the satellite constellation of the Navy Navigation Satellite System. Spacecraft modifications by APL included providing the stable platform and the power, telemetry, and command functions required by the mission, integrating the Defense Nuclear Agency (DNA) experiment, and the development of a deployable ground plane required for the experiment. The existing antenna system was reconfigured and, there being no navigation requirement, the Transit memory was removed.

Physical Characteristics (Fig. IV-6)

Body: Modified Transit spacecraft octagonal body, 48.26 cm across flats and 33.38 cm high, with octagonal experiment structure, 40.01 cm across flats and 22.86 cm high, attached to bottom of spacecraft.

Solar Panels (4): Cells mounted on 167.6 cm by 25.4 cm substrates.

Weight: 71.76 kg.

Features (Fig. IV-7)

Doppler System: Dual temperature-controlled quartz crystal oscillators and 150/400 MHz transmitters (.8W and 1.25W, respectively) provide doppler data for satellite tracking. Oscillator offset is -141.5 ppm to avoid interference with Navy Navigation Satellites. A phase modulator allows TM data transmission on 150 MHz link.

Power System: Solar cells/NiCd batteries and battery charge control unit with low voltage sensing switch to prevent excessive battery discharge.

Attitude Control and Detection Systems: Yo-yo despin mechanism, magnetic hysteresis rods, electromagnet, 29.1 m

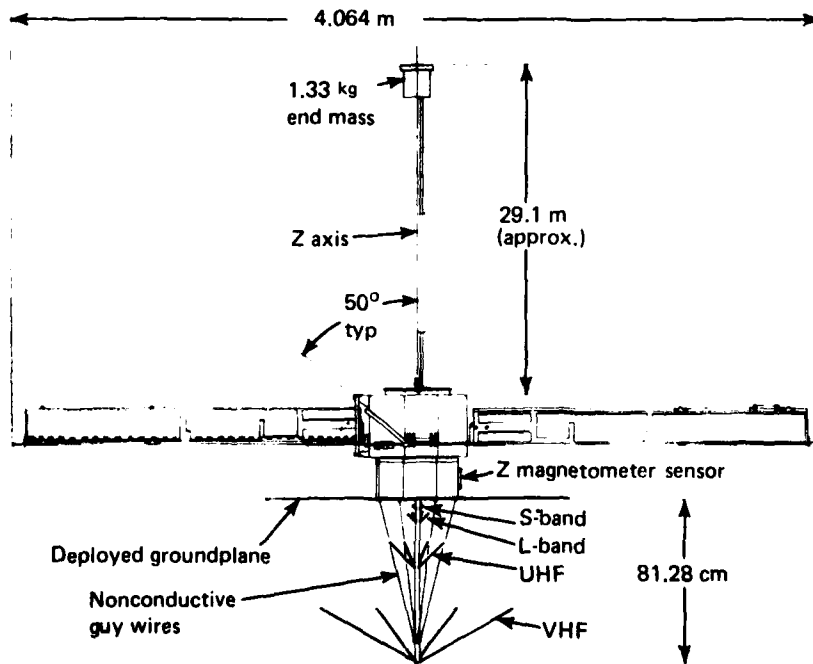
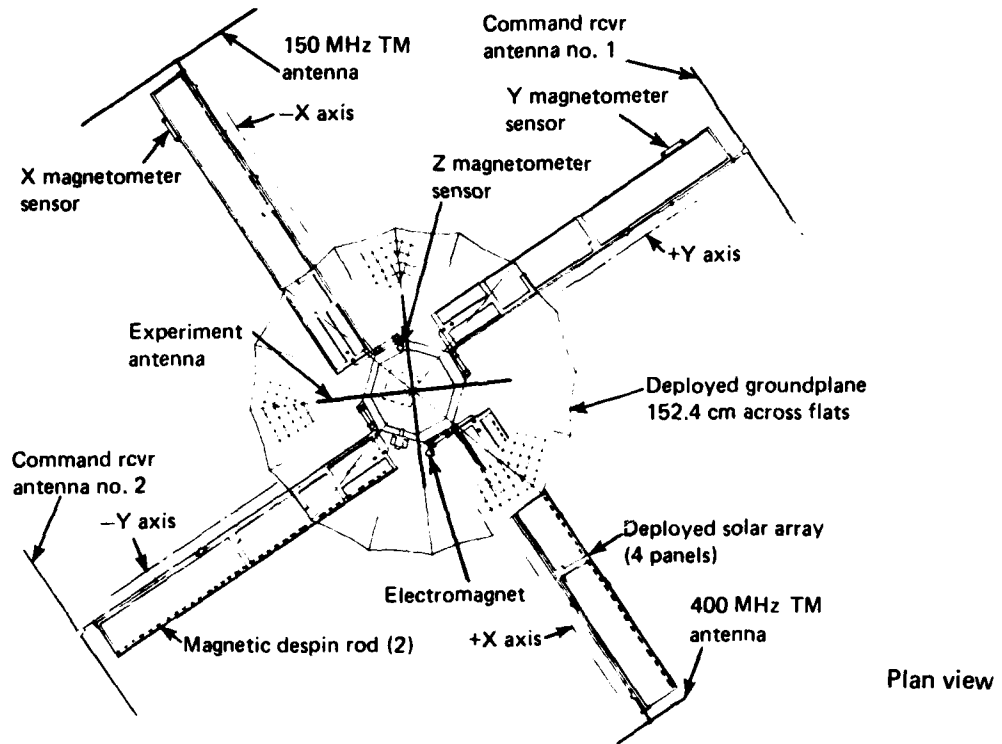

Fig. IV-6 P76-5 Spacecraft Orbital Configuration

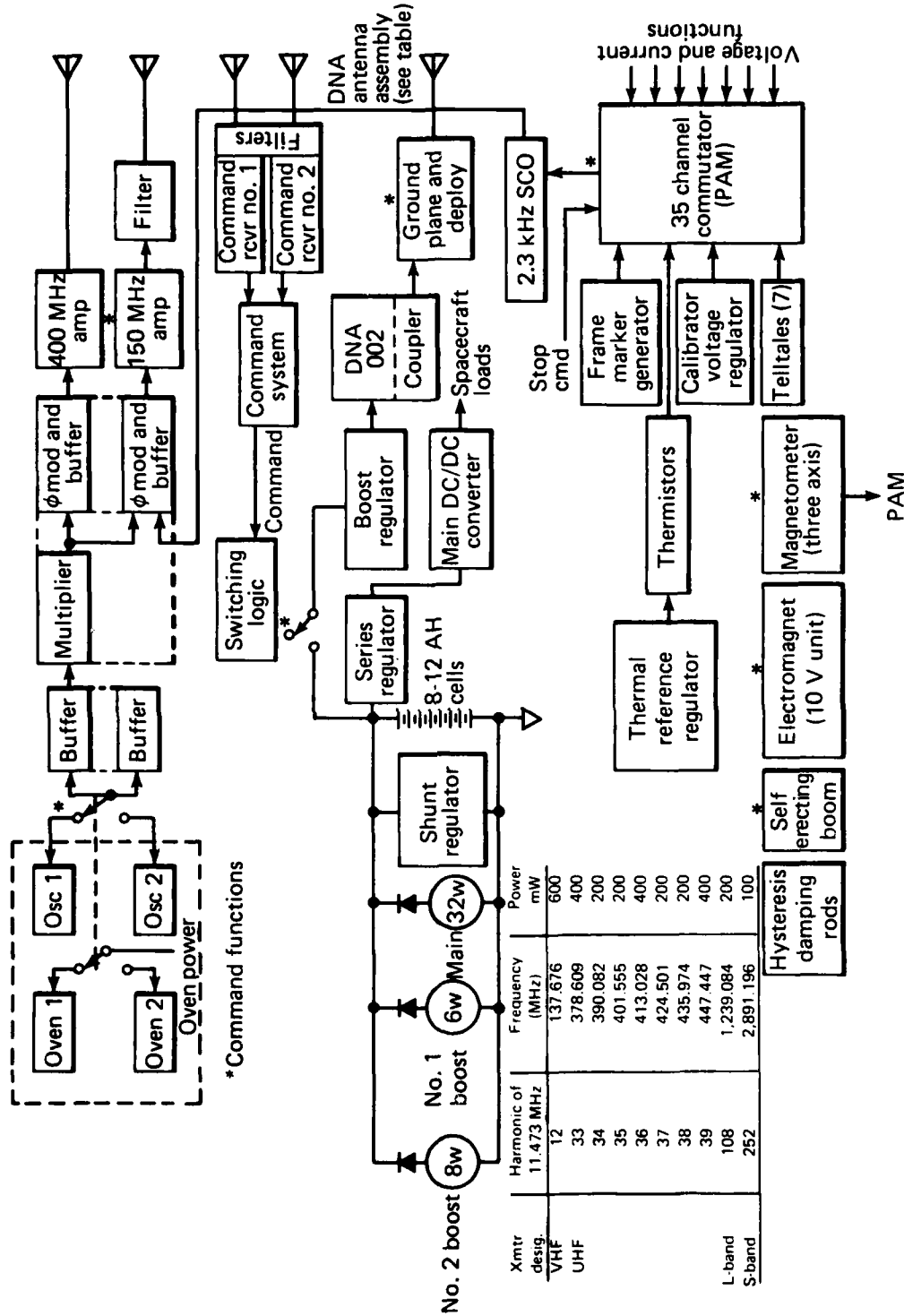

Fig. IV-7 P76-5 Satellite Simplified Block Diagram

extendable boom with 1.33 kg end mass for gravity gradient stabilization, and three magnetometers.

Command System: Redundant receivers, each with an antenna, filter, bit detector, and power switching unit to provide eight commands at a rate of two bits per second.

Telemetry System: Commutated (35 channel) FM/PM housekeeping and calibration data and PCM telltale readouts to verify operating modes and command execution, transmitted on 150 MHz at rate of one second per channel.

Thermal Control: A passive system of multilayered aluminized Mylar-nylon net type insulation, and a thermal shield of aluminized Teflon; an active system of shunt drivers in the control section and shunt resistors in the experiment.

### Objectives

The Stanford Research Institute developed DNA wideband signals experiment is essentially a multi-frequency radio beacon with an antenna assembly consisting of four turnstile antennas mounted on a common mast. The transmitted signals range from VHF to S-band (see table, Fig. IV-7), and are used to:

1. Provide more precise information on the distorting effects of the ionosphere and other structured layers of the earth's environment on RF and radar signals.
2. Obtain a more detailed and complete picture of scintillation (fading and jitter of signals) and scattering effects.
3. Develop procedures for mitigating scintillation effects in naturally disturbed or nuclear environments.

### Achievements

Satellite gravity gradient stabilization was completed on 25 May 1976, and postlaunch checkout indicated satisfactory performance of all satellite control and experiment section systems. The satellite was turned over to the U.S. Navy Astronautics Group on 26 May 1976 for tracking and control. The satellite's sun-synchronous (noon-midnight) circular orbit is one in which the earth-sun line always lies in the orbit plane. This ensures satellite passage over the experiment ground stations (Fairbanks, Alaska; Ancon, Peru; and Stanford, California) around local midnight when the best data can be obtained due to ionospheric conditions. To date, the experiment is on full time and operating properly; TM and doppler systems are being commanded periodically.



SAS-A and -B SATELLITES

SAS-A  
(1970 107A)

SAS-B  
(1972 91A)

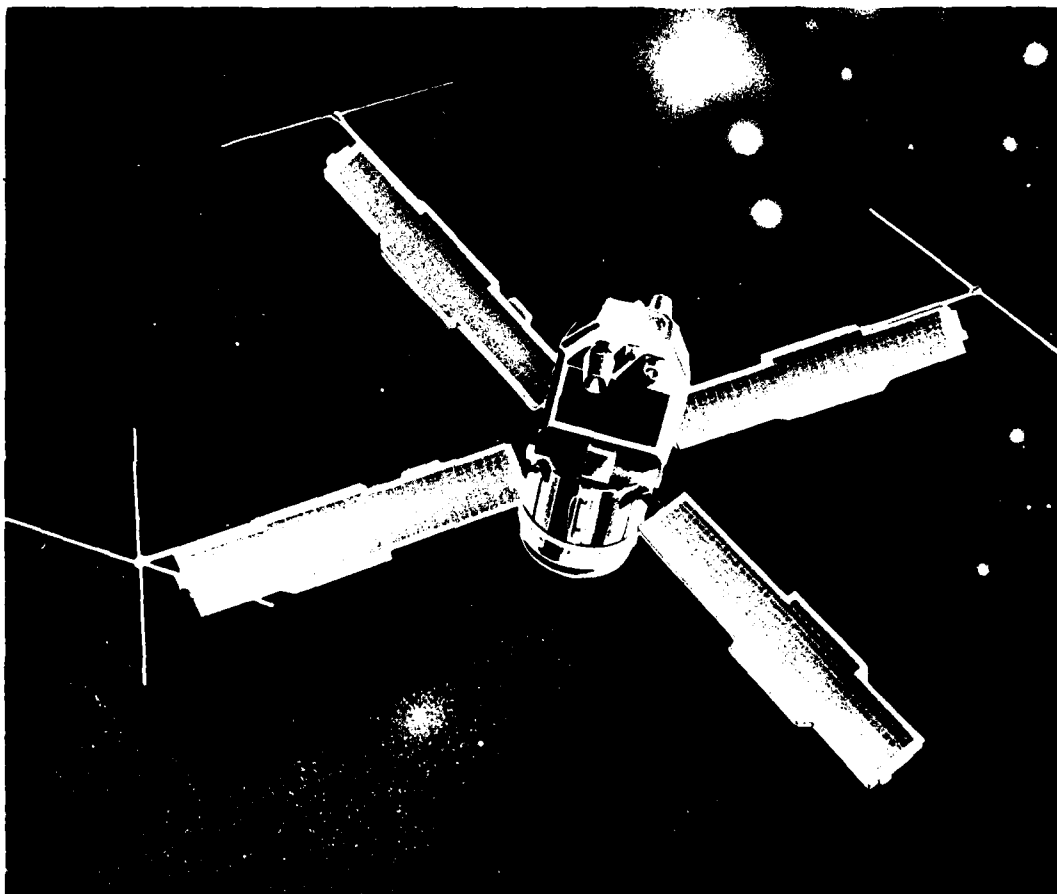

Fig. V-1 SAS-A Satellite, Artist's Concept

SAS-A AND -B SATELLITES

**Launch:** (SAS-A) 12 December 1970; San Marco Equatorial Range, Indian Ocean (Figs. V-1 and V-2)  
(SAS-B) 15 November 1972; San Marco Equatorial Range, Indian Ocean

**Vehicle:** Scout (four stage)

**Orbit:** (SAS-A) Apogee 531.8 km (287 nmi), perigee 502.2 km (271 nmi), inclination 3°  
(SAS-B) Apogee 607.8 km (328 nmi), perigee 439.2 km (237 nmi), inclination 1.9°

**Remarks:** Separation, stabilization, and blade deployment normal.

Background

The Small Astronomy Satellite (SAS) is unique from an engineering standpoint in that the standard satellite subsystems required to support the experiment are self-contained in a control section. The APL developed and fabricated Control Sections are designed to be adaptable to carry a wide variety of experiment packages. The Experiment Section for SAS-A was provided by American Science and Engineering, Inc.; the SAS-B Experiment Section was provided by NASA/GSFC.

Physical Characteristics (Fig. V-3)

**Body:** 129 cm (51 in.) long overall; 55 cm (22 in.) dia. by 50 cm (20 in.) long drum shaped Control Section

**Solar Blades (4):** Each 145 cm (58 in.) by 26 cm (10.5 in.), hinged to Control Section

**Weight:** (SAS-A) 134.55 kg (299 lb) plus 9 kg (20 lb) separation system  
(SAS-B) 174.15 kg (387 lb) plus 9 kg separation system.

Features (Control Section)

**Transmitters:** 136.68 MHz (TM); SAS-B has redundant transmitters

**Power:** Solar array/Ni-Cd batteries provide Experiment and Control Section power



Fig. V-2 SAS-A Liftoff from San Marco Equatorial Range

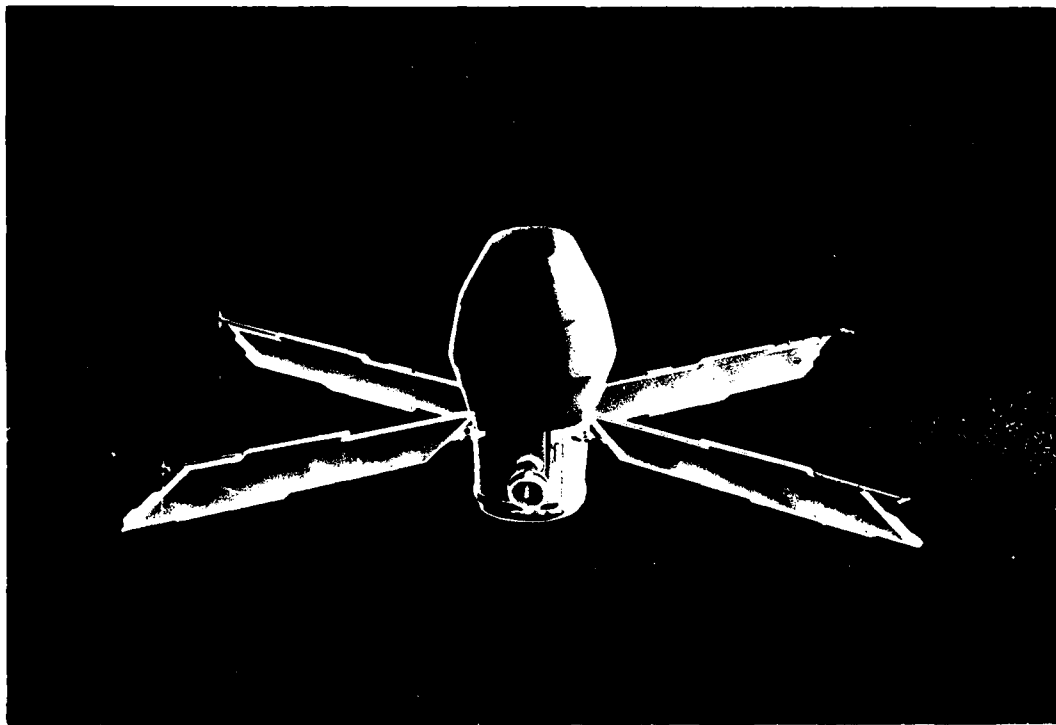

Fig. V-3 SAS-B Satellite, Artist's Concept

Yo-yo despin system

Magnetic attitude control

Momentum wheel

Solar attitude detectors

Nutation damper

Telemetry: PCM/PM system with two 64-channel analog subcommutators. In the record mode, multiplexed data are recorded for a maximum of 100 minutes for transmission in the record mode.

Command System: Completely redundant, employing 64-bit word format transmitted at 64 bps on a 148.98 MHz carrier. Controls 36 relays and provides pulse command and data command services whereby 24-bit words are shifted. Parity check code used to reduce errors.

Antennas: (SAS-A) One turnstile telemetry antenna and two dipole command antennas.

(SAS-B) Two turnstile telemetry antennas and two dipole command antennas.

### Objectives

The basic objective of the Small Astronomy Satellite Program is to survey the celestial sphere and identify sources radiating in the gamma ray, X-ray, ultraviolet, visible, and infrared spectral regions both inside and outside our galaxy. The specific mission objectives are listed in the following paragraphs.

SAS-A:

1. To conduct a high sensitivity, high-resolution, all-sky survey for X-ray sources to produce, with an accuracy of 1 arc-minute for strong sources and approximately 5 arc-minutes for weaker sources, an X-ray source catalog that includes sources of intensity greater than approximately  $5 \times 10^{-4}$  Sco X-1 (the strongest source known).
2. To search for temporal variations of several percent in X-ray source intensity over periods of minutes to months.
3. To determine the spectral distribution of the energy for all sources detected in the energy range from 1 to 20 keV.

SAS-B:

1. To measure the dependence on direction of the galactic and extra-galactic diffuse gamma radiation with an accuracy of about  $1^\circ$  for gamma rays above 100 million electron volts. (Visible star light is in the range of about two electron volts.)
2. To measure the energy spectrum of this gamma radiation as a function of direction in the range from 25 to 200 million electron volts and the integral intensity above 200 million electron volts.
3. To determine whether discrete sources of gamma radiation exist both within and external to our galaxy at a flux level detectable with the experiment telescope and to measure the position, intensity, and energy spectra of any discovered sources
4. To look for short burst of gamma rays from supernovae.
5. To look for pulsed radiation from pulsars in the gamma ray energy region.

Achievements

SAS-A:

A catalog of 125 X-ray sources has been prepared from SAS-A data. In addition, the satellite's important findings include:

1. Discovery of rapidly varying X-ray sources whose properties differ in many respects from those of the more common radio pulsars.
2. The detection of X-ray emission for Seyfert galaxies.
3. Discovery of X-ray emission from peculiar sources such as quasars.
4. Discovery of binary star systems identified solely on X-ray data.
5. Possible data to support the "Black Hole" theory.

SAS-A suffered a tape recorder failure after six weeks in orbit that limited data acquisition to real-time periods over receiving stations within view of the equatorial orbit. Useful data were being received from the satellite until it was turned off on 31 December 1974. SAS-A was designated Explorer 42.

*SAS-B:*

The APL systems for power, command, thermal, and telemetry control operated flawlessly. However, on 8 June 1973 a failure occurred in a power supply of the gamma ray telescope and no useful data were subsequently obtained. Despite the premature failure of the experiment after seven months in orbit, the survey aspect of the experiment was substantially completed, and important research information obtained. High-energy gamma radiation was detected from the Vela region and the Crab Nebula, and the major galactic arms were confirmed to be rich sources of gamma rays. A detailed map of this radiation was prepared. SAS-B was designated Explorer 48.



THE JOHNS HOPKINS UNIVERSITY  
APPLIED PHYSICS LABORATORY  
LAUREL MARYLAND

SDO 1600  
February 1978

SAS-C SATELLITE  
(1975 37A)

V-9

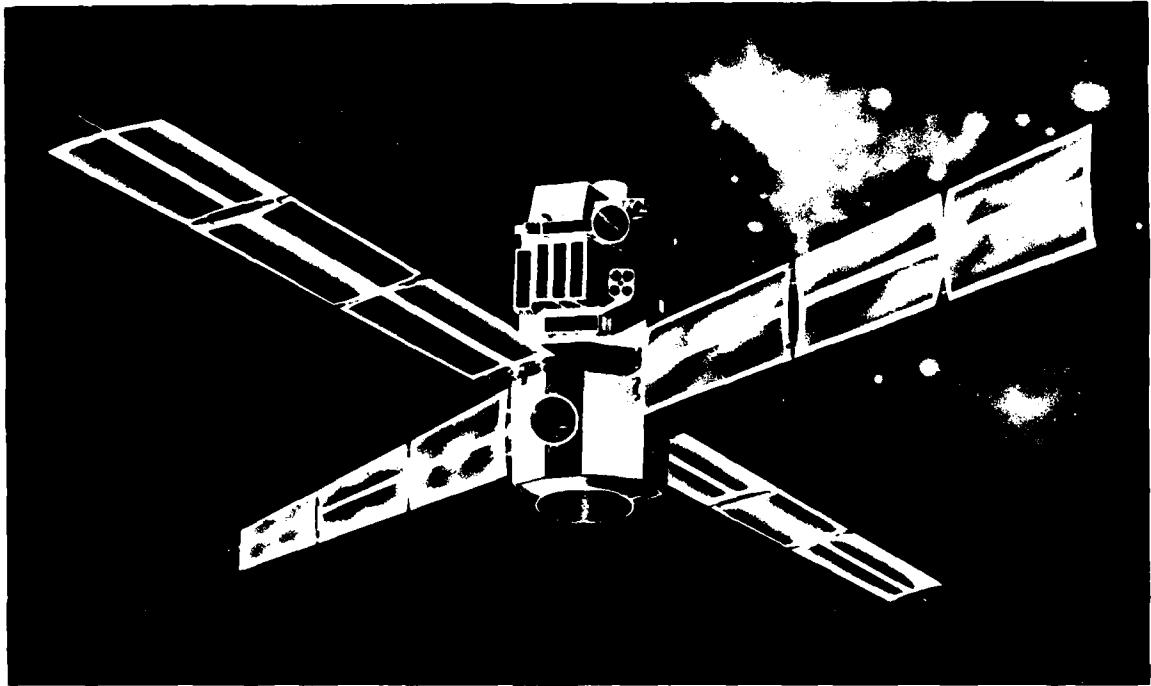

Fig. V-4 SAS-C Satellite, Artist's Concept

SAS-C SATELLITE

Launch: 7 May 1975; San Marco Equatorial Range,  
Indian Ocean

Vehicle: Scout (four stage)

Orbit: Apogee 516.34 km, perigee 509.08 km, inclination  $2.99^{\circ}$

Remarks: The expected orbit was 486 km at an inclination of  $2.9^{\circ}$ ; however, the higher orbit proved more desirable as it allows a longer satellite life.

Background

The standardized control section developed by APL for SAS-C (Small Astronomy Satellite) incorporated several refinements over the SAS-A/B control sections: An improved magnetic torquing attitude control system with variable speed flywheel to allow a dither mode of attitude control and automatic spin rate control, a more precise attitude control capability (better than  $\pm 2^{\circ}$  as compared with  $\pm 5^{\circ}$ ), a more precise final attitude determination capability, and added telemetry and command capacity. In addition, the SAS-C power system included a nondissipating charge control system and solar panels that were rotatable and had curved sections for compact stowage in the Scout launch vehicle. The experiment section for SAS-C was provided by the Massachusetts Institute of Technology/Center for Space Research.

Physical Characteristics (Figs. V-4 and V-5)

Body: 145.18 cm long overall; irregular polygon control section 66 cm dia. by 61 cm long.

Solar Blades (4): Each blade comprised of three sections each 63.5 cm long by 36.6 cm wide which are folded against each other during launch. After deployment in orbit, either set of opposing blades can be rotated through  $90^{\circ}$  to obtain maximum power.

Weight: 196.7 kg plus 6.9 kg separation system.

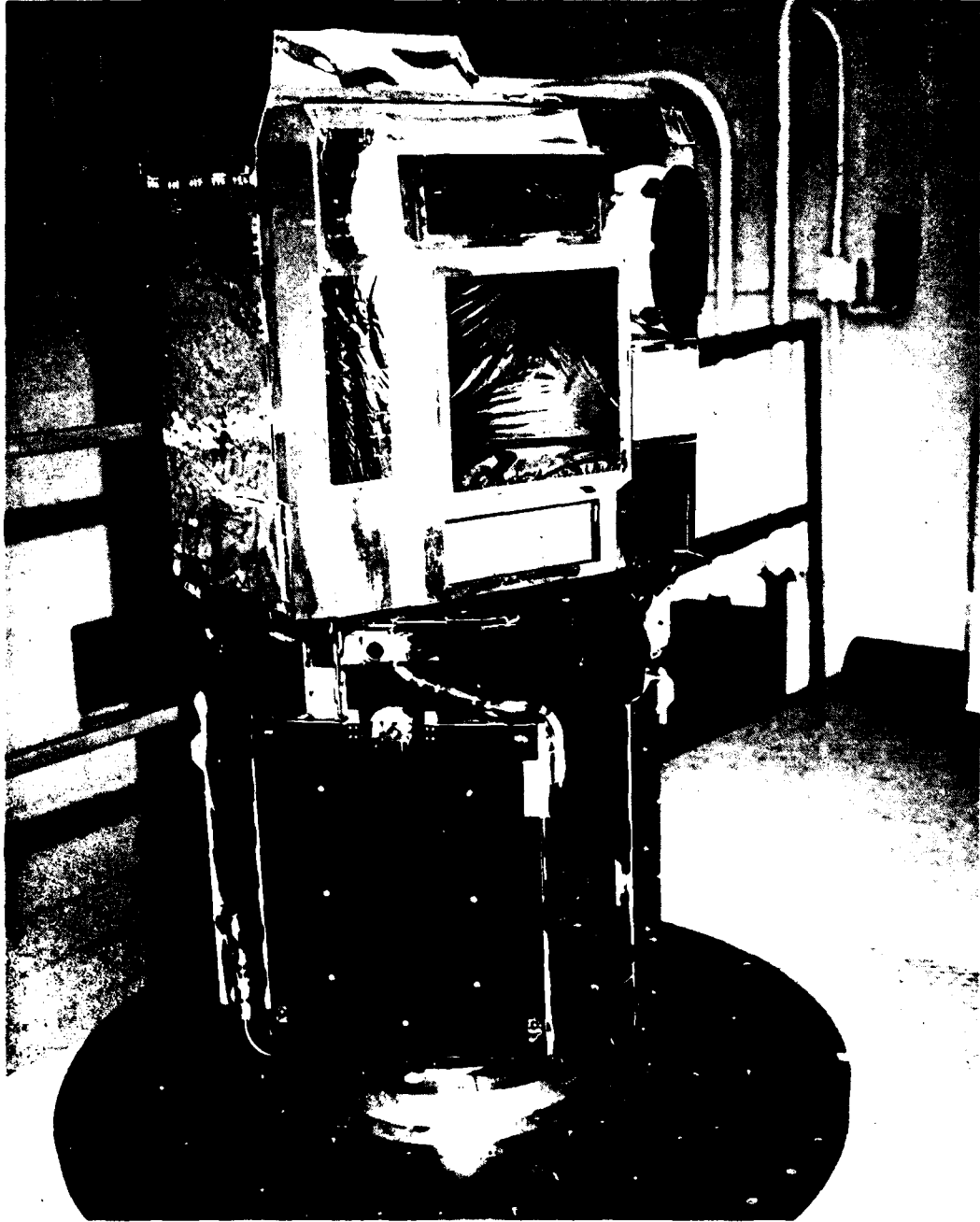

Fig. V-5 SAS-C Satellite Mounted on Spin Table

### Features (Control Section; Fig. V-6)

Two oven-controlled crystal oscillators

Transmitters: Dual 136.68 MHz (TM)

Power: Solar array/Ni-Cd batteries

Yo-yo despin system

Magnetometers, sun sensors, and a star sensor for attitude determination

Attitude Control and Stabilization: Magnetically torqued commandable system with IR scanner/reaction wheel and gyro for closed-loop spin rate control

Telemetry: PCM/PM, programmable in flight system with two 16-channel digital and three 64-channel analog sub-commutators. Real time and playback modes of operation using redundant tape recorders

Command System: Completely redundant, employing 64-bit word format transmitted at 64 bps on a 148.98 MHz carrier. Controls 56 relays and provides pulse command and data command services whereby 24-bit words are shifted. Parity check code used to reduce errors. System permits execution of real time and delayed commands; dual delayed command system provides storage of up to 15 commands in each system for later execution. Long-load data command capacity up to 4096 bits

Antennas: Two turnstile TM antennas and one dipole antenna; command system uses the dipole and one pair of elements of one of the turnstile antennas.

### Objectives

The SAS-C experiment section includes a Galactic Absorption Experiment, a Scorpio Monitor Experiment, a Galactic Monitor Experiment, and an Extragalactic Experiment, each with an independent detection system. The basic SAS-C objective is to measure the X-ray emission of discrete extragalactic sources, to monitor the intensity and spectra of galactic X-ray sources from 0.1 to 50 keV, and to monitor the X-ray intensity of SCO X-1. The following areas of X-ray astronomy are being investigated:

1. The location of X-ray sources to 15 arc-seconds.
2. The existence and identification of very weak extragalactic sources.

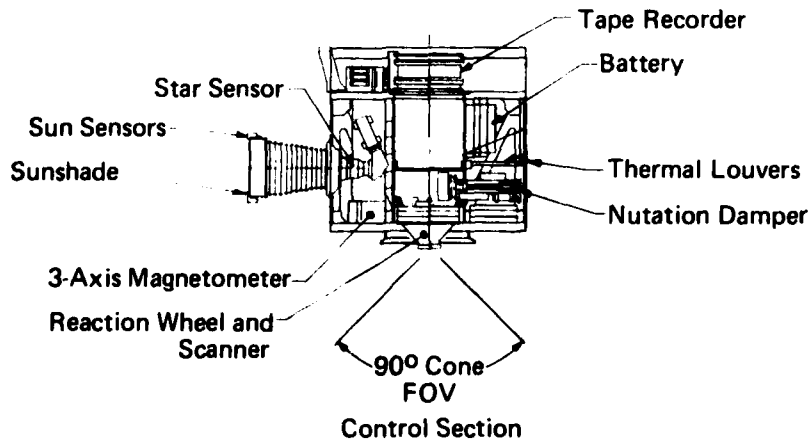
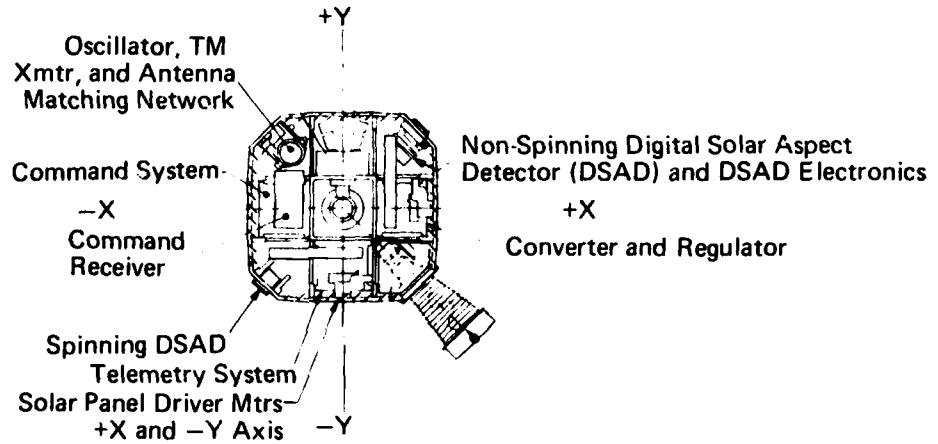
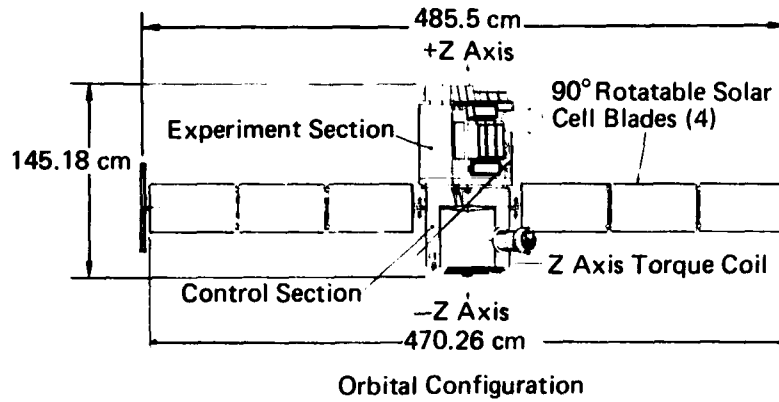

Fig. V-6 SAS-C Control Section and Orbital Configuration

3. The properties of transient X-ray phenomena associated with novas and supernovas.
4. The absorption of the low-energy diffuse X-ray background by interstellar matter.
5. The long and short term variations of SCO X-1.
6. The detailed energy spectrum of X-ray sources and the background from 0.1 kev to 50 kev.
7. The periodic time variations of X-ray sources (e.g., X-ray pulsars) with periods greater than  $10^{-3}$  seconds.

#### Achievements

All satellite subsystems are operating satisfactorily, and the MIT Center for Space Research reports that excellent data are being returned. More than 60 scientific papers on findings obtained from SAS-C data have been published. As expected, some battery degradation has occurred after over two and one-half years in orbit; however, normal satellite operations are being maintained by frequent adjustment of the solar blade angles to suit the sun angle and therefore increase the available charge current.

APPENDIXES



## Appendix A

### DEFINITIONS AND ABBREVIATIONS

AEC	Atomic Energy Commission (now Energy Research and Development Administration)
AFCRL	Air Force Cambridge Research Laboratory
Alert	A time ordered list of predicted satellite pass times for a given location.
ANNA	Army, Navy, NASA, Air Force (Satellite)
Apogee	In an orbit about the earth, that point in the orbit of a satellite at which the satellite is farthest from earth.
APL	Applied Physics Laboratory (Johns Hopkins University)
Argument of Perigee	The angle, as seen from the focus of the ellipse (at the center of the earth), from the ascending node to the point of perigee. The angle lies in the orbital plane, and is measured in the direction of the satellite motion.
Ascending Node	The point at which the satellite crosses the equator northbound, measured in a counter-clockwise direction from the first point of Aries.
ATC	Automatic Temperature Control
BE	Beacon Explorer (satellite)
CA	Closest Approach (of a satellite)
CCID	Continuous Count Integral Doppler
DATS	Despun Antenna Test Satellite
DB	Doppler Beacon (1) A 162/324 MHz doppler instrument package, (2) a satellite carrying (1).
DISCOS	Disturbance Compensation System
DME	Direct Measurement Explorer (satellite)
DoD	Department of Defense
DODGE	Department of Defense Gravity Experiment (satellite)

DRTE	Defence Research Telecommunications Establishment (Ottawa, Canada)
Epoch	A reference point in time; the origin of a time scale
ESSA	Environmental Science Services Administration
ETR	Eastern Test Range
FM	Frequency Modulation
GEOS	Geodetic Earth Orbiting Satellite
GEOS	Geodynamics Experimental Ocean Satellite
GSFC	Goddard Space Flight Center (NASA), Greenbelt, Md.
IPS	Incremental Phase Shifter
Inclination	Angle between the orbital plane and the earth's equatorial plane (or the celestial equator)
ISIS	International Satellite for Ionospheric Studies
LES	Lincoln Experimental Satellite
LIDOS	Low Inclination Doppler Only Satellite
NAFI	Naval Avionics Facility, Indianapolis
NASA	National Aeronautics and Space Administration
NAVSAT	Navigation Satellite
NGSP	National Geodetic Satellite Program
NNSS	Navy Navigation Satellite System
NOTS	Naval Ordnance Test Station (China Lake, California)
NRL	Naval Research Laboratory
Oscar	Operational (Navy Navigation Satellite)
PAM	Pulse Amplitude Modulation
PDA	Passive Delay Actuator
PDM	Pulse Data Modulation
Perigee	In an orbit about the earth, that point at which the satellite is nearest the earth.

Period	The interval required for a satellite to complete an orbit
PFM	Pulse Frequency Modulation
PPM	Parts per Million
PRF	Pulse Repetition Frequency
PRN	Pseudorandom Noise
RIPS	Radioisotope Power Supply
R&RR	Range and Range Rate
RMS	Root mean square
RTG	Radioisotope Thermoelectric Generator
SAS	Small Astronomy Satellite
Scintillation	The rapid fluctuation in phase and amplitude of satellite signals, the result of the passage of the radio wave through an irregular ionosphere, in which the latter acts as a diffraction grating.
SECOR	Sequential Collation of Range
SNAP	Systems for Nuclear Auxiliary Power (AEC Program)
TCA	Time of Closest Approach (of a satellite)
TRAAC	Transit Research and Attitude Control (satellite)
TRANET	Tracking Network
TRIAD	Three body (satellite)
USC&GS	US Coast and Geodetic Survey (Department of Commerce)
VAFB	Vandenberg Air Force Base, California
WTR	Western Test Range

## Appendix B

### THE NAVY NAVIGATION SATELLITE SYSTEM

One of the earliest programs designed to put space systems to practical use was the US Navy program to establish a navigation capability through the use of artificial satellites. The program, conceived and developed by the Applied Physics Laboratory of the Johns Hopkins University, was started in 1959 and became operational under the control of the Navy Astronautics Group in 1964. The NNSS is a worldwide, all-weather system that provides accurate position fixes from data collected during a single pass of an orbiting satellite.

#### System Description

The system (Fig. B-1) consists of at least four earth orbiting satellites (There are presently six operational navigation satellites.), four tracking stations, two injection stations, a computing and control center, and any number of navigation sets. Each of the operational satellites is placed in a nominally circular polar orbit at an altitude of 500-700 (nominal 600) nmi. The orbital planes of the satellites, in the case of four satellites, are spaced 45 degrees apart in longitude (Fig. B-2); the orbital paths cross at the North and South Poles. Although the orbital planes remain nearly fixed in space, to an observer on the earth the satellites appear to move westward as the earth rotates.

Each satellite orbits the earth in approximately 108 minutes, continually transmitting the following phase-modulated data every two minutes on two RF carriers: time synchronization signals, a 400 MHz tone, and fixed and variable parameters describing its own orbit.

The fixed parameters describe the satellite's nominal orbit and are correct only for a 12- to 16-hour interval. The variable parameters are small corrections to the nominal orbit at two-minute time points describing the fine structure in the satellite orbit. The satellite memory stores sufficient variable parameters to provide the two-minute orbit corrections for 16 hours

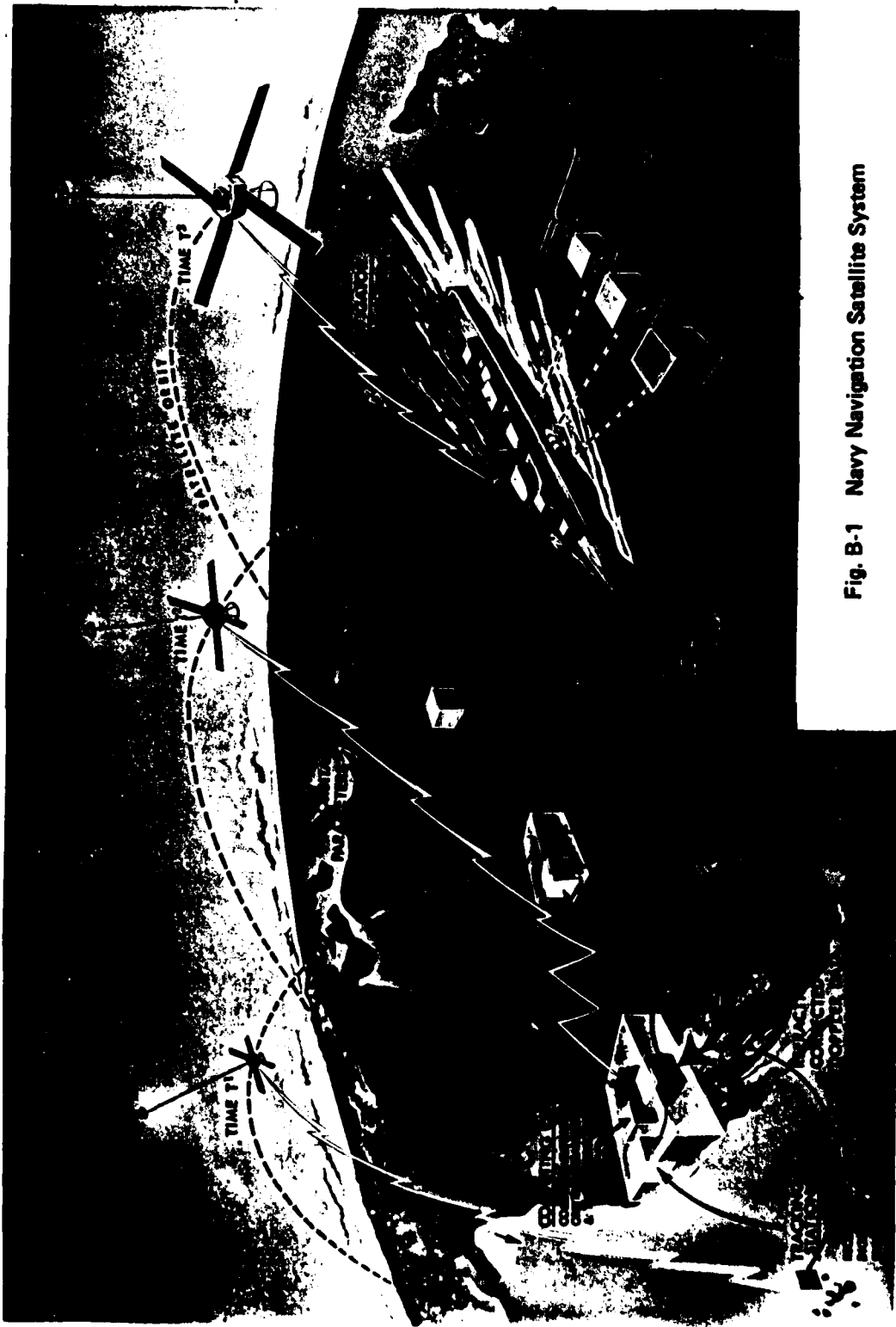

Fig. B-1 Navy Navigation Satellite System

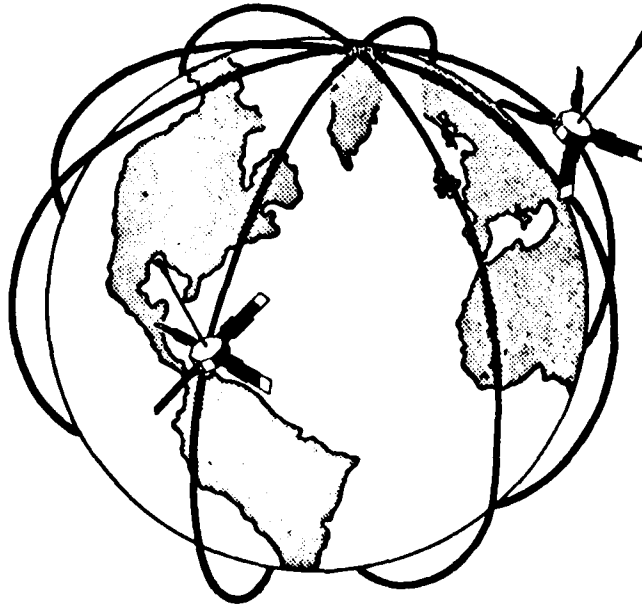

Fig. B-2 Navy Navigation Satellites in Polar Orbits with  $45^{\circ}$  Nodes

following injection of fresh data into the memory. Since injections occur about every 12 hours, the satellite memory is not allowed to run out. Each two-minute satellite message is timed so that the end of the 78th bit, which is the last bit of the second synchronization signal, coincides with the even two minutes of Universal Time Coordinated (UTC). Thus, the satellites also serve as an accurate time reference for all navigators that are equipped to receive and decode satellite transmissions.

In order to determine accurately its present and future orbit for the 12- to 16-hour interval after data injection, each satellite is tracked as it passes within radio line-of-sight of each of four fixed tracking stations located in Hawaii, California, Minnesota, and Maine. Each station includes radio receiving and data processing equipment that receives and decodes the satellite transmissions, and a tracking antenna that has a

directional pattern and must be programmed to point toward the satellite throughout the duration of the pass. The directional antenna pattern permits greater antenna gain and offers an additional measure of discrimination against spurious signals from Loran transmitters. It also insures tracking the selected satellite during those instances when two satellites are within radio line-of-sight.

The programming data for pointing the Tracking Station antenna either originate at the Central Computing Center and are routed through the Control Center to the Tracking Station or are locally derived at the Tracking Station. Just prior to the satellite time-of-rise at the Tracking Station, the antenna is pointed to acquire the satellite signals. As the satellite rises above the horizon, the antenna continues to follow the pass, allowing the radio receiver in the Tracking Station to lock on the signals. The receiver and data processing equipment receives, decodes, and records the satellite message. The doppler signal is digitized and sent with satellite time measurements via the Control Center to the Central Computing Center.

The Central Computing Center continually accepts data inputs on the operational satellites from the four Tracking Stations. Periodically, to obtain the fixed orbital parameters for a satellite, the Central Computing Center computes an accurate orbit for each satellite that best fits the doppler curves obtained from all Tracking Stations. Then, using a complex mathematical model of the earth's gravity field, the Central Computing Center extrapolates the position of the satellite at each even two minutes in Universal Time Coordinated for the next 12 to 16 hours subsequent to the time of data injection. These data, the commands and time correction data for the satellite, and the antenna-pointing orders for the Injection Station antennas are supplied to the Injection Station via the Control Center.

The Injection Stations, after receiving and verifying the incoming message from the Control Center, store the message until it is needed for transmission to the satellite. Just prior to the satellite time-of-rise at an Injection Station, the Injection Station antenna is pointed to acquire, lock on, and track the satellite throughout the pass. As soon as the receiving equipment

at the Injection Station receives and locks to the satellite signals, the Injection Station transmits the orbital data and appropriate commands to the satellite. Transmission to the satellite is at a high bit rate so that the injection is completed in a matter of seconds.

The next message transmitted by the satellite during its pass contains part of the newly injected data. In the Injection Station this readback is compared with the data that the satellite should be transmitting as a check for errors. Since most of the newly injected data (the variable parameters) will not be transmitted until the appropriate time during the satellite orbit, the initial readback from the satellite includes parity check data. These data provide for error detection of the variable parameters so that the Injection Station can verify that the parameters were received correctly.

If no errors are detected, injection is complete. If one or more errors are noted, injection is repeated at two-minute intervals (updating the variable parameters as necessary) until the satellite transmission is verified as being correct or until the satellite is no longer available for data injection.

Once data injection is complete, the satellite continues to transmit the normal two-minute messages. Any time-corrections for the satellite clock and any commands for the satellite, such as changeover to the standby oscillator, cease transmission, etc., also are performed during the period of data injection. These precautions ensure that user navigation receivers, which depend on accurate satellite data for determining position, are provided with the best possible data from each satellite. Any time that the satellite is within radio line-of-sight of the navigation equipment and has a maximum elevation angle at time of closest approach equal to or greater than 10 degrees and equal to or less than 70 degrees, the satellite transmission can be used to compute the exact position. Satellite passes suitable for use in obtaining a navigation fix will generally occur at least every two hours.

#### Integrated Doppler Navigation

The navigation fix obtained with a satellite radio navigation set is based on the shift in frequency (doppler frequency shift) that occurs whenever the relative



distance between a radio transmitter and receiver is changing. Such a change can be measured by a receiver whenever a transmitting navigation satellite passes within radio range and is due to the combination of three effects:

1. Motion of the satellite in its orbit.
2. Motion of the navigator on the earth's surface.
3. Rotation of the earth (and therefore of the navigator) about the earth's axis.

It follows that motion of the navigator must be properly measured or estimated and inserted into the computation if accurate fixes are to be obtained.

The integral of the doppler shift over a two-minute interval (measured by the navigation receiver doppler frequency counter that is controlled by the two-minute time markers received from the satellite) is a measure of how much the slant range from satellite to navigator has changed during this two-minute interval. In order to derive his position, the navigator also needs to know the position of the satellite in its orbit every two minutes. As stated previously, these satellite positions every two minutes on the even minute can be calculated from the data message that is present as phase modulation on the 150 and 400 MHz RF carriers. The information inputs required for computing a fix are then as follows:

1. Two-minute doppler frequency counts (Integrated Doppler).
2. Satellite orbital position every two minutes.
3. Navigator's estimated position.
4. Antenna height above the geoid.

Figures B-3 and B-4 illustrate how the measurements are made and how the navigation fix is computed after the satellite data are taken. In Fig. B-3, the satellite positions in orbit are shown for times  $t_1$  through  $t_4$ , which are the even minutes at which the satellite transmits its synchronization signal. The positions of the navigator,  $p_1$  through  $p_4$ , refer to the times at which the navigation receiver recognizes the satellite synchronization signal, i.e., times  $t_1 + \Delta t_1$  through  $t_4 + \Delta t_4$ . Note that the times of reception are slightly later than the times of transmission because

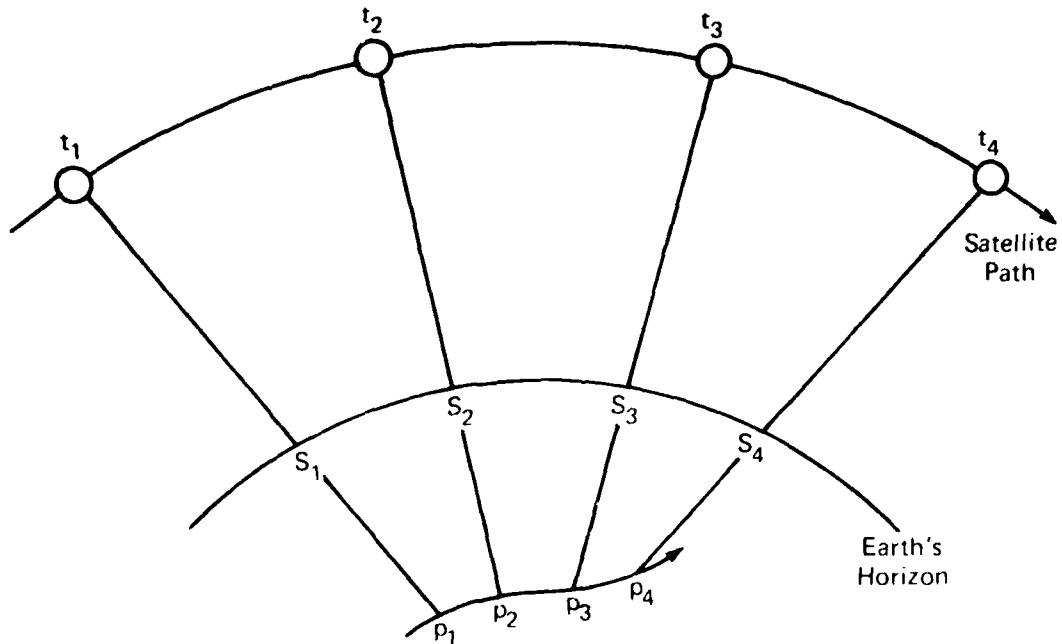

$f_0$  = Nominal Value of Navigator's Reference Frequency

$c$  = Speed of Light

$\Delta f$  = Difference between Navigator's Reference Frequency and Satellite Transmission Frequency

$p$  = Navigator's Position

$T$  = 2 Minutes (i.e.,  $t_2 - t_1$ ,  $t_3 - t_2$ , etc.)

$\phi$  = Latitude

$\lambda$  = Longitude

$t$  = Time of Transmission of Timing Mark

$t + \Delta t$  = Time of Reception of Timing Mark

$N$  = Doppler Count

$S$  = Slant Range

$$N_{12} = f_0 c |S_2(\phi, \lambda) \cdot S_1(\phi, \lambda)| + \Delta f \cdot T$$

$$N_{23} = f_0 c |S_3(\phi, \lambda) \cdot S_2(\phi, \lambda)| + \Delta f \cdot T$$

$$N_{34} = f_0 c |S_4(\phi, \lambda) \cdot S_3(\phi, \lambda)| + \Delta f \cdot T$$

Fig. B-3 Integrated Doppler Measurement

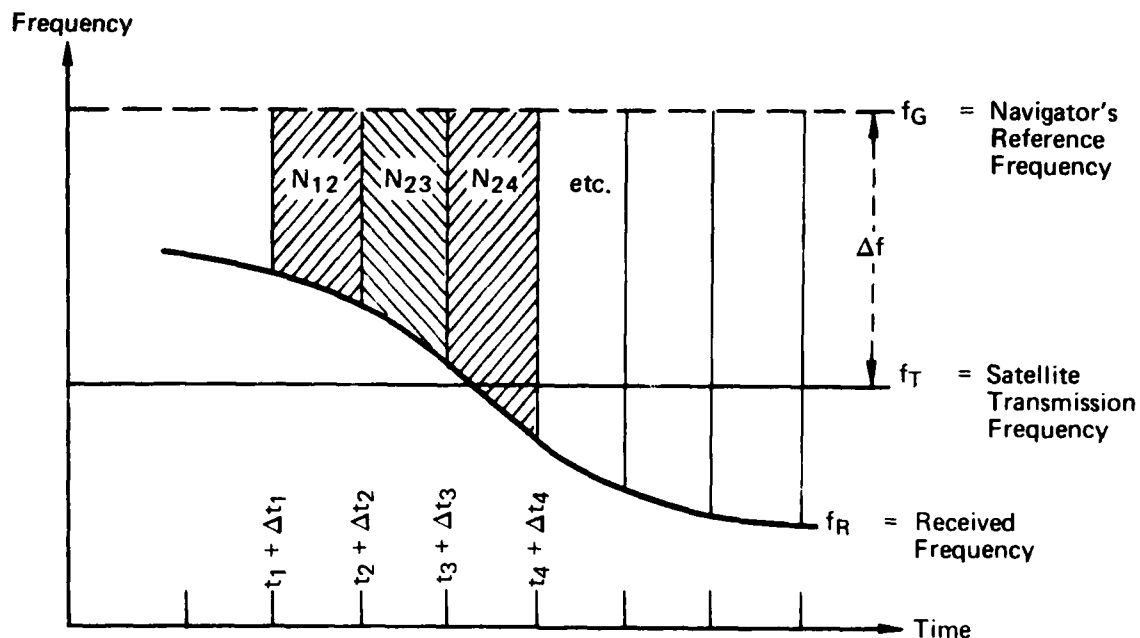

Fig. B-4 Doppler Frequency Variation with Time

of the radio propagation time over the slant ranges  $S_1$ ,  $S_2$ ,  $S_3$ , and  $S_4$ . Also, since the propagation times  $\Delta t_1$ ,  $\Delta t_2$ ,  $\Delta t_3$ , and  $\Delta t_4$  are not all equal, the time intervals over which the receiver makes integral doppler measurements will differ slightly from the exact two-minute value, being somewhat smaller prior to satellite closest approach (while  $S$  is decreasing). This fact, however, does not affect the result of the measurement because the number of RF cycles transmitted by the satellite between synchronization signals (exactly two minutes apart) must necessarily equal the number received by the navigator between receptions of the synchronization signals, since no RF cycles can be "lost" or "gained."

The integral doppler measurements are simply the count  $N_{12}$  of the number of doppler cycles received between  $t_1 + \Delta t_1$  and  $t_2 + \Delta t_2$ , the count  $N_{23}$  of the number of doppler cycles between  $t_2 + \Delta t_2$  and  $t_3 + \Delta t_3$ , and so on for all two-minute intervals during the satellite pass. These counts are a direct measure of

the amount by which the slant range from satellite to navigator has changed ( $S_2 - S_1$ ,  $S_3 - S_2$ , etc.) during the count intervals. This measure is quite accurate since each doppler count added (or subtracted) due to the relative motion means that  $S$  has decreased (or increased) by one wavelength, or by  $3/4$  meter at 400 MHz. Therefore, one of the required inputs to the fix computation (slant range increment over each two-minute interval) is directly measured by the integral doppler count, suitably scaled as indicated in Fig. B-3. Note that the slant ranges  $S_1$  through  $S_4$  (and therefore their differences, or slant range increments) are all functions of the navigator's position ( $\phi$ ,  $\lambda$ ). Since the satellite orbital positions can be calculated by the receiver from the data recovered from the signal phase modulation, and since the navigator's estimated position every two minutes is available, values of estimated slant range from satellite to navigator can be computed. These estimated slant ranges are differenced to obtain estimated slant range increments, which can then be compared with the slant range increments measured as already described by means of the integral doppler counts.

Unless the navigator's estimate of his position happens to be exactly correct, there will, of course, be a difference or residual when each estimated slant range increment is subtracted from the corresponding measured increment. The fix calculation then consists of changing the navigator's estimate of position ( $\phi$ ,  $\lambda$ ) in small steps until the sum of the squares of the slant range residuals is minimized, at which point the closest achievable agreement exists between the (revised) estimates and the measures of slant range increment. The values of  $\phi$  and  $\lambda$  so determined (i.e., the revised estimates that yield the smallest residual) are then the fix result, which is printed out at the end of the fix computation.

In practice, two factors complicate this simple explanation, and therefore represent extra computing steps in the fix calculation:

1. The frequency of the satellite oscillator and also that of the reference oscillator used in the receiver are constant but not precisely known to the navigator.

2. The process of minimizing the sum of the squares of the differences between the estimated and measured slant range differences calls for a number of different manipulations to be performed in the computer used to calculate the navigation fix and is, in fact, an iterative process wherein the same mathematical steps are successively repeated in the same sequence several times in order to get the final result.

The absolute values of the satellite and receiver oscillator are not required in the computation provided that they are constant—only their difference ( $\Delta f$ ) is of interest. Since  $\Delta f$  is not known to the navigator and cannot be directly estimated or measured, and since its actual value affects the numbers obtained for the measured integral two-minute doppler counts, it must be solved for (in addition to  $\phi$  and  $\lambda$ ) in the calculation of the navigation fix. Note that the value of  $\Delta f$  does not affect the estimated slant range increments—only the measured increments defined by the integral doppler counts  $N_{12}$  through  $N_{34}$ . There are then three quantities to be determined:  $\phi$ ,  $\lambda$ , and  $\Delta f$ , the last mentioned being of no immediate interest to the navigator but essential to the accurate determination of  $\phi$  and  $\lambda$ . This means that integral doppler counts for at least three two-minute intervals must be used (and preferably more than three) in order to determine the three unknowns,  $\phi$ ,  $\lambda$ , and  $\Delta f$ .

That the integral doppler counts  $N_{12}$  through  $N_{34}$  are directly affected by  $\Delta f$  is illustrated in Fig. B-4, wherein  $f_G$  is the (constant) frequency of the navigator's reference oscillator,  $f_T$  is the (constant) frequency of the satellite's transmitter,  $f_R$  is the received frequency containing the doppler component, and  $\Delta f = f_G - f_T$ . The integral doppler counts,  $N_{12}$ , etc., are represented by the shaded areas.

Since the values of three quantities ( $\phi$ ,  $\lambda$ , and  $\Delta f$ ) have to be simultaneously adjusted in minimizing the sum of the squares of the differences between estimated and measured slant range for three (or more) two-minute intervals, the computations involve the solution of a matrix whose exact description is beyond the scope of this appendix. The general idea, however, can be illustrated as follows:

1. The measured slant range increments are calculated from the integral doppler counts for an assumed value of  $\Delta f$ . Their rate of change as  $\Delta f$  changes is also determined.

2. The navigator's positions at the times  $t_1$ ,  $t_2$ , etc., are calculated for an assumed initial position  $(\phi, \lambda)$ .

3. Using previously calculated satellite positions at  $t_1$ ,  $t_2$ , etc., the estimated satellite-navigator slant range increments (for the assumed initial  $\phi, \lambda$  are calculated).

4. The rate of change (partial derivative) of the estimated slant range increments (item 3 above) with respect to  $\phi$  is determined.

5. The partial derivative of the estimated slant range increments with respect to  $\lambda$  is determined.

6. The differences (residuals) between measured slant range increments (item 1) and estimated slant range increments (item 3) are formed for each two-minute interval.

7. Using the derivative of measured slant range increment with respect to  $\Delta f$ , that of estimated slant range with respect to  $\phi$ , and that of estimated slant range with respect to  $\lambda$ , new values of  $\phi$ ,  $\lambda$ , and  $\Delta f$  are calculated such that the sum of the squares of the residuals will be smaller than before these new values are used.

8. Steps 1 through 7 are repeated several times until the newly calculated values of  $\Delta f$ ,  $\phi$ , and  $\lambda$  differ from the last values used by less than fixed threshold values. At this point the computing stops, and the last set of values of  $\Delta f$ ,  $\phi$ , and  $\lambda$  is the final result.

#### Satellite Message Organization

The satellite message (Fig. B-5), transmitted in a two-minute interval, consists of 6103 binary bits organized into 156 words of 39 bits each plus a 19 bit word. The last 25 bits of word 2 are a synchronizing pattern consisting of 1 zero, 23 ones, and another zero (0111111111111111111111110) as shown in Fig. B-6. The end of the zero bit of the synchronizing word or the

		<i>Two Minute Time Mark Doppler Printed Out</i>		<i>Refraction Printed Out</i>			
1	3	4	5	6	7	8	1st Ephemeral Word
2	9	10	11	12	13	14	2nd Ephemeral Word
3	15	16	17	18	19	20	
4	21	22	23	24	25	26	
5	27	28	29	30	31	32	
6	33	34	35	36	37	38	
7	39	40	41	42	43	44	
8	45	46	47	48	49	50	8th Ephemeral Word
9	51	52	53	54	55	56	1st Kepler Word
10	57	58	59	60	61	62	2nd Kepler Word
11	63	64	65	66	67	68	
12	69	70	71	72	73	74	
13	75	76	77	78	79	80	
14	81	82	83	84	85	86	
15	87	88	89	90	91	92	
16	93	94	95	96	97	98	
17	99	100	101	102	103	104	
18	105	106	107	108	109	110	
19	111	112	113	114	115	116	
20	117	118	119	120	121	122	
21	123	124	125	126	127	128	
22	129	130	131	132	133	134	
23	135	136	137	138	139	140	
24	141	142	144	144	145	146	
25	147	148	149	150	151	152	17th Kepler Word
26	153	154	155	156	A	B	
27						C	

Note: Word A - Word 157 (19 bits) plus first 20 bits of word one  
 Word B - Last 19 bits of word one plus first 20 bits of word two  
 Word C - Last 19 bits of word two

Example:

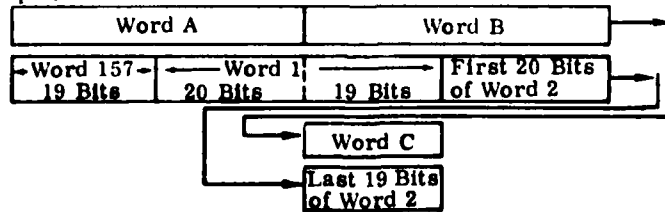

Fig. B-5 Organization of Satellite Message

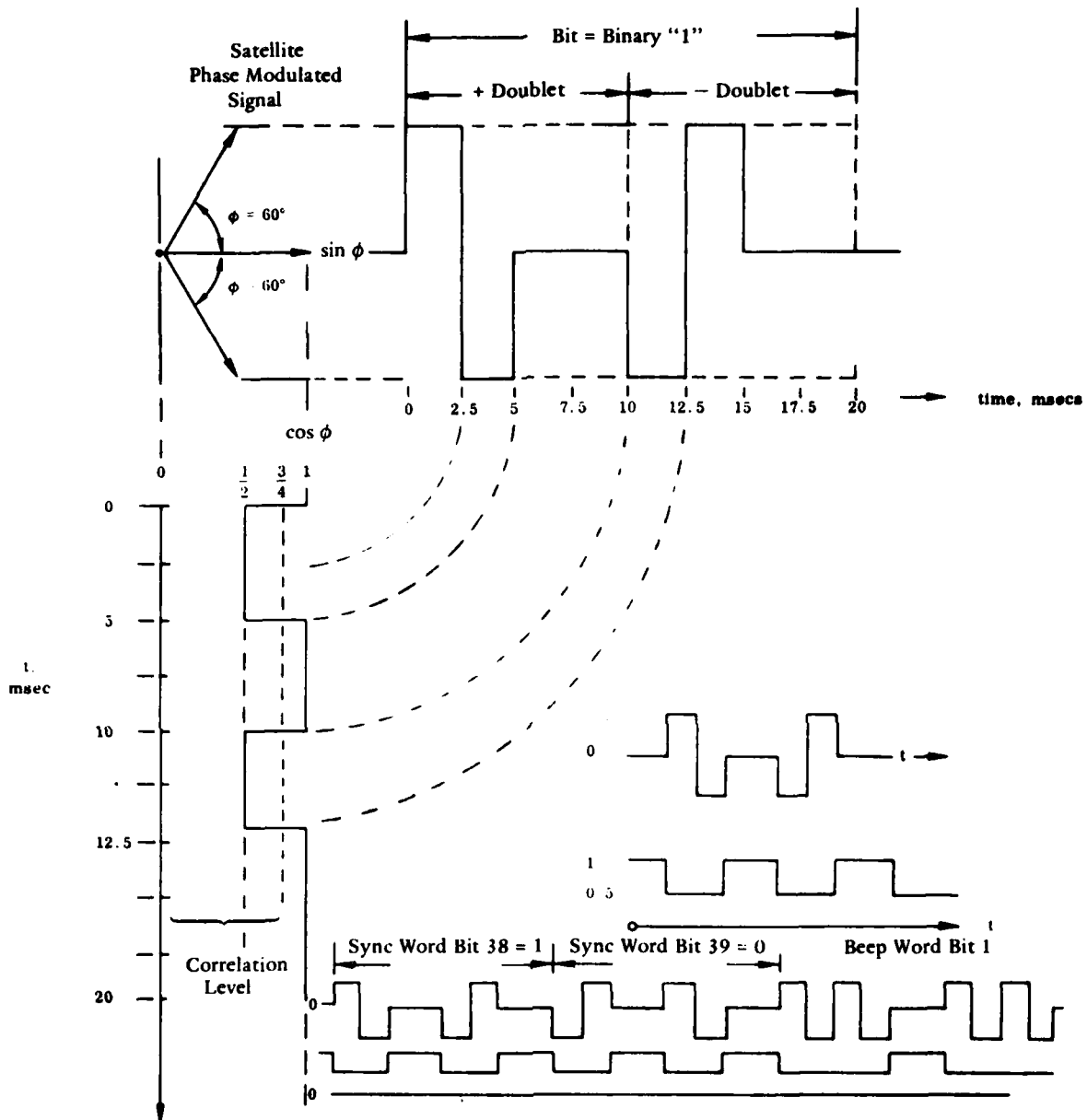

Fig. B-6 Detected Signal Characteristics



beginning of the first bit of word 3 (The so-called beep word which may be used as a time mark to set the navigator's chronometer ) is the two-minute time mark. Satellite message transmission is precisely controlled so that these two-minute time marks are normally transmitted within a tolerance of 1 millisecond.

Only every sixth word starting with word 8 is required for navigation. Figure B-7 shows a section of a typical printout consisting of every sixth word in the satellite message starting with word 8 and a two-minute doppler count as obtained by the navigator. Most receivers use only the data contained in the first 36 bits of each word. These are transmitted as nine Binary Coded Decimal Excess Three (BCDXS3) digits.

The transmission format for a typical word (specifically, word 8 in Fig. B-7) is illustrated in Fig. B-8. Each of the word's nine characters is represented by four BCDXS3 bits. Since two doublets comprise a binary bit, each message word contains 36 bits. Actually, the satellite transmits 39 bits per word, 36 of which are used. The bit information (2 doublets) is transmitted at the rate of approximately 50 bits per second. Therefore, the doublet transmission rate is approximately 100 bits per second.

As can be seen in Fig. B-7, the data consist of doppler counts, refraction counts, and data words received from the satellite. The satellite data words allow calculation of the satellite's position at particular points in time. The doppler counts provide information on the navigator's position relative to the satellite, and the refraction counts provide information for making a correction of the doppler counts.

#### Accuracy Considerations

The following factors will determine the final accuracy of the navigation fix:

1. Accuracy of satellite orbit determination and orbit prediction.
2. Number of two-minute doppler intervals received - four to six two-minute intervals are recommended; three two-minute intervals are required.

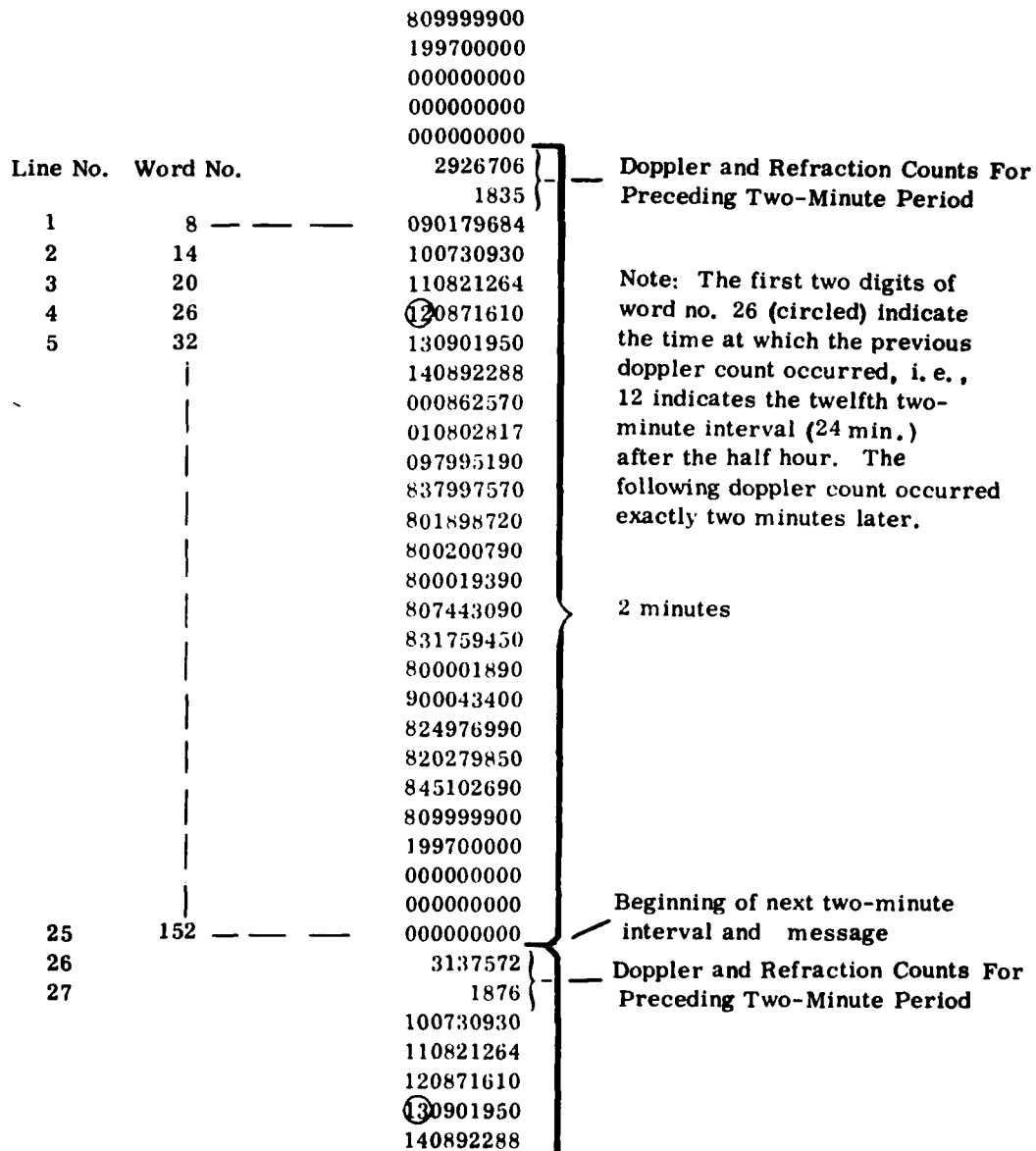

Note: The first two digits of word no. 26 (circled) indicate the time at which the previous doppler count occurred, i. e., 12 indicates the twelfth two-minute interval (24 min.) after the half hour. The following doppler count occurred exactly two minutes later.

Fig. B-7 Typical Two-Minute Message Printout

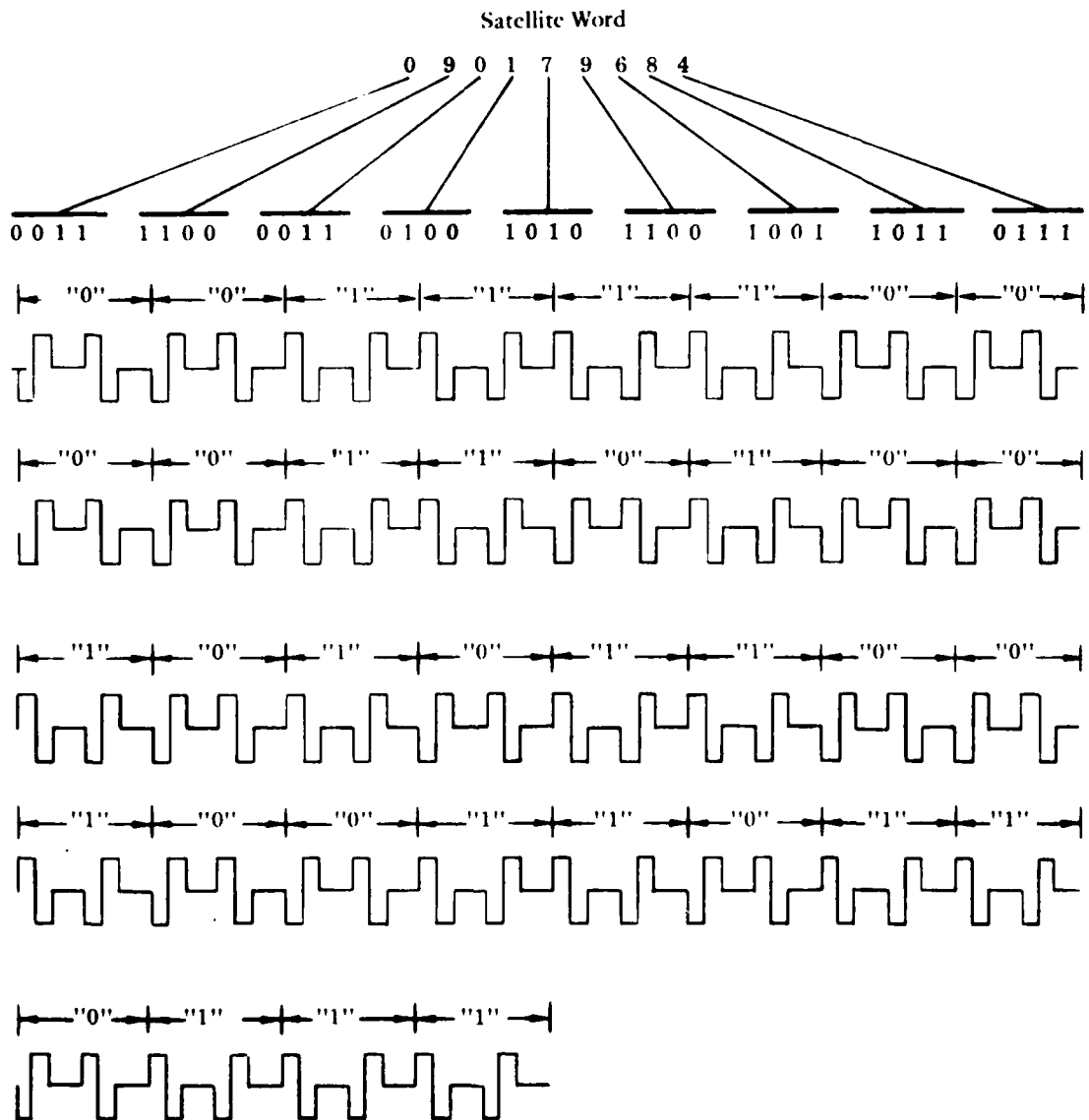

Fig. B-8 Satellite Word Code Format

3. Accuracy of the doppler measurements, which is a function of the stability of the satellite oscillator and the receiver oscillator.

4. Effects of ionospheric refraction, which are minimized by the use of a dual frequency system.

5. In the case of ship navigation, accuracy of determination of ship's course and speed (e.g., a 1-knot error in velocity north will contribute approximately a 0.2 nmi error to the navigational fix; errors in velocity east are less serious.)

6. Symmetry of doppler data collected (data biased to one side or the other of the satellite maximum elevation - as determined from the elevation azimuth printout - will degrade fix results).

7. Antenna height errors (although a pass geometry sensitive error source, it is approximately true that a ten meter antenna height error will produce at least a 30 meter position error on a  $70^\circ$  pass).

## Appendix C

### BIBLIOGRAPHY

This appendix contains a bibliography on the Navy Navigation Satellite System, which also includes geodetic studies (Table C-1); a bibliography of papers based on data from the 5E satellites (Table C-2); and a bibliography on the DODGE satellite (Table C-3). These are not comprehensive bibliographies, but rather material that is readily available to any technical library. References are primarily to the published journal literature, and classified material has been excluded.

#### Table C-1

##### Navy Navigation Satellite System Bibliography

1. R. W. Blevins, L. D. Eckard, and I. B. Irving, "The Transit Satellite Thermal-Vacuum Test Program," JHU/APL, Sect. T, CM-977, July 1960.
2. R. F. Freitag, "Project Transit: A Navigation Satellite," (Inst. Navigation, Annual Meeting, 16th, Colorado Springs, Colo., June 23-25, 1960.) Navigation, Vol. 7, Summer-Autumn 1960, pp. 106-116.
3. William H. Guier, "The Tracking of Satellites by Doppler Methods," Space Research, International Space Science Symposium, Proceedings of the First, edited by H. K. Kallmann Bijl. Amsterdam, North-Holland Publishing Co. (1960), 481-491.
4. Henry B. Riblet, "A Broad-Band Spherical Satellite Antenna," IRE Proceedings, 48 (April 1960), pp. 631-635.

Table C-1 (Continued)  
Navy Navigation Satellite System Bibliography

5. M. A. Schreiber and T. Wyatt, "Evolution and Testing of a Navigational Satellite," (AIEE, Pacific Gen. Meeting, San Diego, California, Aug. 8-12, 1960, Paper CP60-1038.) Elec. Eng., Vol. 79, December 1960 pp. 1033-1040.
6. W. C. Scott, "Development of the Power Supply of the Transit Satellite," JHU/APL, Sect. T, CM-986, December 1960.
7. W. H. Guier and G. C. Weiffenbach, "A Satellite Doppler Navigation System," IRE Proceedings, 48 (April 1960), pp. 507-516.
8. George C. Weiffenbach, "Measurements of the Doppler Shift of Radio Transmissions from Satellites," IRE Proceedings, 48 (April 1960), pp. 750-754.
9. J. W. Hamblen and J. B. Oakes, "Instrumentation and Telemetry of Transit Navigational Satellites," Electronics, Vol. 34, August 11, 1961, pp. 148-153.
10. R. B. Kershner, "Transit Program Results," Astronautics, Vol. 6, May 1961, p. 30, 31, 106-114 (ff.).
11. R. R. Newton, H. S. Hopfield, and R. C. Kline, "Odd Harmonics of the Earth's Gravitational Field," Nature, 190 (May 13, 1961), pp. 617-618.
12. J. D. Nicolaides, "Project Transit - Earth and Aerospace Navigational Satellite System," (IAS, Annual Meeting, 29th, New York, N. Y., January 23-25, 1961.) Aerospace Eng., Vol. 20, February 1961, p. 20, 21, 60-65 (ff.).
13. J. F. Swale, "Navigational Satellites," The Aeroplane & Astronautics, Vol. 100, June 22, 1961, pp. 728-729.
14. E. Golton, "Ionospheric Research Through Transit," Inst. Navigation, J., Vol. 15, April 1962, pp. 154-157.

Table C-1 (Continued)  
Navy Navigation Satellite System Bibliography

15. W. H. Guier, "Navigation Using Artificial Satellites - The Transit System," The Use of Artificial Satellites for Geodesy; Proceedings of the First International Symposium on the Use of Artificial Satellites for Geodesy, Washington, D.C., April 26-28, 1962. Committee on Space Research (COSPAR), International Union of Geodesy and Geophysics, and UNESCO. Edited by G. Veis. John Wiley and Sons, Inc., 1963, pp. 261-276.
16. R. R. Newton, "Ellipticity of the Equator Deduced from the Motion of Transit 4A," J. Geophys. Res., Vol. 27, January 1962, pp. 415-416.
17. R. R. Newton, "Non-Zonal Harmonics Deduced From the Motion of Transit 4A," The Use of Artificial Satellites for Geodesy; Proceedings of the First International Symposium on the Use of Artificial Satellites for Geodesy, Washington, D.C., April 26-28, 1962. Committee on Space Research (COSPAR), International Union of Geodesy and Geophysics, and UNESCO. Edited by G. Veis. John Wiley and Sons, Inc., 1963, pp. 323-328.
18. A. M. Stone and G. C. Weiffenbach, "Radio Doppler Method of Using Satellites for Geodesy, Navigation and Geophysics," Progress in the Astronautical Science, Vol. I. Amsterdam, North-Holland Publishing Co., 1962, pp. 93-144.
19. J. Dassoulas, "Transit/ANNA Flight Test Operations," American Institute of Aeronautics and Astronautics, Space Flight Testing Conference, Cocoa Beach, Florida, March 18-20, 1963, Paper 63105-63.
20. J. P. Debarber, G. E. Chisholm, and W. J. Ross, "The Nature of the Irregularities in Ionization Density Causing Scintillation in Satellite Signals," International Conference on the Ionosphere, Proceedings. London, The Institute of Physics and The Physical Society, pp. 267-270.
21. A. Moody, "Non-Military Navigation by Satellites," Institute of Navigation, Journal, Vol. 16, January 1963, pp. 9-13.

Table C-1 (Continued)

Navy Navigation Satellite System Bibliography

22. J. Aarons, J. Mullen, and S. Basu, "The Statistics of Satellite Scintillations at a Sub-Auroral Latitude," Journal of Geophysical Research, Vol. 69, May 1, 1964, pp. 1785-1794.
23. R. R. Newton, "Errors in Long-Term Orbital Prediction for Satellite 196101," Journal of Geophysical Research, Vol. 69, September 1, 1964, pp. 3619-3624.
24. W. H. Guier, "Satellite Navigation Using Integral Doppler Data - The AN/SRN-9 Equipment," Journal of Geophysical Research, Vol. 71, December 15, 1966, pp. 5903-5910.
25. W. Ireland and G. F. Preddey, "Site Effects in Scintillation Studies Using Satellite Transmissions," Journal of Atmospheric and Terrestrial Physics, Vol. 28, May 1966, pp. 481-487.
26. G. F. Stuart and J. E. Titheridge, "The Height of Large Ionospheric Irregularities," Journal of Atmospheric and Terrestrial Physics, Vol. 28, February 1966, pp. 255-258.
27. R. E. Fischell, "Solar Cell Power Systems for APL Satellites," Institute of Electrical and Electronics Engineers, Photovoltaics Specialists Conference, 6th, Cocoa Beach, Florida, March 28-30, 1967, Conference Record, Volume 2 - Spacecraft Power Systems, Solar Cell Mathematical Model. (A67-41505 23-03), New York, Institute of Electrical and Electronics Engineers, Inc., 1967, pp. 32-53.
28. R. R. Newton, "Everyman's Doppler Satellite Navigation System," IEEE Transactions on Aerospace and Electronic Systems, Vol. AES-3, May 1967, pp. 527-554.
29. J. Chernof, "Utilization of Satellite Navigation Techniques in Marine Operations," (American Institute of Aeronautics and Astronautics, Marine Systems and ASW Meeting, 3rd, San Diego, California, April 29-May 1, 1968, Paper 68-471 ) Journal of Hydronautics, Vol. 3, April 1969, pp. 102-104.



Table C-1 (Continued)

Navy Navigation Satellite System Bibliography

30. R. S. Allen, "Comparison of Scintillation Depths of Radio Star and Satellite Scintillations," Journal of Atmospheric and Terrestrial Physics, Vol. 31, February 1969, pp. 289-297.
31. K. S. Budlong, "A Simplified Method for Predicting Satellite Passes," Journal of Spacecraft and Rockets, Vol. 6, November 1969, pp. 1341-1343.
32. E. F. Gallagher, "Expanded Application of Navy Navigation Satellite System in Marine and Air Navigation," (Institute of Navigation, Annual Meeting, 24th, U.S. Naval Postgraduate School, Monterey, California, June 19-21, 1968.) Navigation, Vol. 16, Spring 1969, pp. 56-60.
33. R. B. Kershner, "The United States Navy Navigation Satellite System," Advanced navigational techniques; NATO, AGARD, Symposium, 14th, Milan, Italy, September 12-15, 1967, Proceedings. (A70-23026 09-21) Edited by W. T. Blackband, Slough, England, Technivision Services (AGARD Conference Proceedings No. 28), 1970. pp. 184-191, Discussion pp. 192-194.
34. D. G. King-Hele and H. Hiller, "Equations for 15th-order Harmonics in the Geopotential," Nature Physical Science, Vol. 235, February 14, 1972, pp. 130-131.
35. L. M. Laidet, "Worldwide Synchronization Using the Transit Satellite System," IEEE, Proceedings, Vol. 60, May 1972, pp. 630-632.
36. R. L. Easton, "The Role of Time/Frequency in Navy Navigation Satellites," IEEE, Proceedings, Vol. 60, May 1972, pp. 557-563.
37. V. L. Pisacane and M. M. Feen, "Potential of the Navy Navigation Satellite System in Predicting Ionospheric Characteristics," Signal, Vol. 27, Nov. 1972, pp. 14-18.

Table C-1 (Continued)

Navy Navigation Satellite System Bibliography

38. G. Bradshaw, F. Postula, and W. Haggis, "Description and Status of the Transit Thermoelectric Converter," Intersociety Energy Conversion Engineering Conference, 7th, San Diego, Calif., September 25-29, 1972, Proceedings (A73-22751 09-03) American Chemical Society, 1972, pp. 200-215.
39. G. B. Bradshaw and E. J. Steeger, "Application of Isotec Thermoelectric Technology," Energy 70; Proceedings of the Fifth Intersociety Energy Conversion Engineering Conference, Las Vegas, Nevada, September 21-25, 1970. Volume 2 (A73-25976 11-03) American Nuclear Society, 1972, pp. 15-26 to 15-30.
40. R. J. Anderle, "Geodetic Control with Doppler," Photogrammetric Engineering, Vol. 39, May 1973, pp. 515-519.
41. T. B. Merkel, "Military Application of the Transit Navigation Satellite System in the P-3C ASW Aircraft," National Aerospace Meeting, Washington, D.C. March 13, 14, 1973, Proceedings. (A73-40035 21-22) Institute of Navigation, 1973, pp. 39-42.
42. V. L. Pisacane, B. B. Holland, and H. D. Black, "Recent /1973/ Improvements in the Navy Navigation Satellite System," National Aerospace Meeting, Washington, D.C., March 13, 14, 1973, Proceedings. (A73-40035 21-22) Institute of Navigation, 1973, pp. 35-38.
43. E. F. Prozeller and V. Schwab, "The TRIAD PRN Navigation Experiments," APL Technical Digest, Vol. 13, Apr.-June 1974, pp. 12-21.
44. V. L. Pisacane and M. M. Feen, "Potential of the Transit System in Ionospheric Studies," International Symposium on Space Technology and Science, 10th, Tokyo, Japan, September 3-8, 1973. Proceedings. (A74-42352 21-31) Tokyo, AGNE Publishing, Inc., 1973, pp. 909-916.
45. J. Dassoulas, "The TRIAD Spacecraft," APL Technical Digest, Vol. 12, Apr.-June 1973, pp. 2-13.

Table C-1 (Concluded)

Navy Navigation Satellite System Bibliography

46. D. B. DeBra, "Disturbance Compensation System Design," APL Technical Digest, Vol. 12, Apr.-June 1973, pp. 14-26.
47. R. E. Jenkins, "Performance in Orbit of the TRIAD Disturbance Compensation System," APL Technical Digest, Vol. 12, Apr.-June 1973, pp. 27-35.
48. V. L. Pisacane and M. M. Feen, "Propagation Effects at Radio Frequencies on Satellite Navigation Systems," American Institute of Aeronautics and Astronautics, Communications Satellite Systems Conference, 5th, Los Angeles, Calif., Apr. 22-24, 1974. Paper 74-429.
49. J. A. Perschy, B. M. Elder, and H. K. Utterback, "TRIAD Programmable Computer," APL Technical Digest, Vol. 12, Oct.-Dec. 1973, pp. 12-20.
50. J. R. Albertine, "An Azimuth Determination System Utilizing the Navy Navigation Satellites," Institute of Navigation, Marine Meeting, Kings Point, N.Y., Oct. 23-24, 1973, Navigation, Vol. 21, Spring 1974, pp. 54-60.

Table C-2

Publications Based on Satellite 5E Data

1. C. O. Bostrom and D. J. Williams, "Time Decay of the Artificial Radiation Belt," J. Geophys. Res., Vol. 70, 1965, pp. 240-242.
2. D. J. Williams and A. M. Smith, "Daytime Trapped Electron Intensities at High Latitudes at 1100 Kilometers," J. Geophys. Res., Vol. 70, 1965, pp. 541-556.
3. D. J. Williams and W. F. Palmer, "Distortions in the Radiation Cavity as Measured by an 1100 Kilometer Polar Orbiting Satellite," J. Geophys. Res., Vol. 70, 1965, pp. 557-567.
4. D. J. Williams, "A 27-Day Periodicity in Outer Zone Trapped Electron Intensities," J. Geophys. Res., Vol. 71, 1966, pp. 1815-1826.
5. D. J. Williams and G. D. Meade, "Nightside Magnetosphere Configuration as Obtained from Trapped Electrons at 1100 Kilometers," J. Geophys. Res., Vol. 70, 1965, pp. 3017-3029.
6. D. J. Williams, "Studies of the Earth's Outer Radiation Zone," APL Technical Digest, Vol. 4, July-August 1965.
7. D. J. Williams, "Outer Zone Electrons," Radiation Trapped in the Earth's Magnetic Field, Proceedings of the Advanced Study Institute, Bergen, Norway, August 16-September 3, 1965, Edited by Billy M. McCormac.
8. D. J. Williams and J. W. Kohl, "Loss and Replacement of Electrons at Middle Latitudes and High B Values," J. Geophys. Res., Vol. 70, 1965, pp. 4139-4150.
9. N. F. Ness and D. J. Williams, "Correlated Magnetic Tail and Radiation Belt Observations," J. Geophys. Res., Vol. 71, 1966, pp. 322-325.
10. D. J. Williams, "A Diurnal Variation in Trapped Electron Intensities at L-2.0," J. Geophys. Res., Vol. 71, 1966, pp. 979-981.

Table C-2 (Continued)

Publications Based on Satellite 5E Data

11. A. J. Zmuda, "Ionization Enhancement from Van Allen Electrons in the South Atlantic Magnetic Anomaly," J. Geophys. Res., Vol. 71, 1966, pp. 1911-1917.
12. D. J. Williams and N. F. Ness, "Simultaneous Trapped Electron and Magnetic Tail Field Observations," J. Geophys. Res., Vol. 71, 1966, pp. 5117-5128.
13. A. J. Zmuda, "The Auroral Oval," APL Technical Digest, Vol. 6, 1966, pp. 2-8.
14. A. J. Zmuda, J. H. Martin, and F. T. Heuring, "Transverse Magnetic Disturbances at 1100 Kilometers in the Auroral Region," J. Geophys. Res., Vol. 71, 1966, pp. 5033-5045.
15. A. J. Zmuda, F. T. Heuring, and J. H. Martin, "Dayside Magnetic Disturbances at 1100 Km in the Auroral Oval," J. Geophys. Res., Vol. 72, 1967, pp. 1115-1117.
16. D. J. Williams, "On the Low Altitude Trapped Electron Boundary Collapse During Magnetic Storms," J. Geophys. Res., Vol. 72, 1967, pp. 1644-1646.
17. D. S. Beall, C. O. Bostrom, and D. J. Williams, "Structure and Decay of the Starfish Radiation Belt, October 1963 to December 1965," J. Geophys. Res., Vol. 72, 1967, pp. 3403-3424.
18. R. E. Fischell, J. H. Martin, W. E. Radford, and W. E. Allen, "Radiation Damage to Orbiting Solar Cells and Transistors," APL/JHU Report, TG-886, March 1967.
19. J. F. Arens and D. J. Williams, "Examination of Storm Time Outer Zone Electron Intensity Changes at 1100 Kilometers," Proceedings of the Conjugate Point Symposium, IV-22-1 - IV-22-4; June 1967.
20. C. O. Bostrom, J. W. Kohl, and D. J. Williams, "The Feb. 5, 1965 Solar Proton Event: 1 Time History & Spectrums Observed at 1100 Km," J. Geophys. Res., Vol. 72, 1967, pp. 4487-4496.

Table C-2 (Continued)

Publications Based on Satellite 5E Data

21. D. J. Williams and C. O. Bostrom, "The Feb. 5, 1965 Solar Proton Event: 2 Low Energy Proton Observations and Their Relation to the Magnetosphere," J. Geophys. Res., Vol. 72, 1967, pp. 4497-4506.
22. A. M. Smith, "Stellar Photometry from a Satellite Vehicle," Astrophysical Journal, Vol. 147, 1967, pp. 158-171.
23. T. A. Potemra, A. J. Zmuda, C. R. Haave, and B. W. Shaw, "VLF Phase Perturbations Produced by Solar Protons in the Event of February 5, 1965," J. Geophys. Res., Vol. 72, 1967, 6077-6089.
24. A. J. Zmuda, W. E. Radford, F. T. Heuring, and P. Verzariu, "The Scalar Magnetic Intensity at 1100 Km in Middle and Low Latitudes," J. Geophys. Res., Vol. 73, 1968, pp. 2495-2503.
25. F. T. Heuring, A. J. Zmuda, W. E. Radford, and P. Verzariu, "An Evaluation of Geomagnetic Harmonic Series for 1100 Kilometer Altitude," J. Geophys. Res., Vol. 73, 1968, pp. 2505-2511.
26. C. O. Bostrom, "Solar Protons Observed at 1100 Km during March 1966," Annales de Geophysique, Vol. 24, 1968, pp. 841-845.
27. D. S. Beall, "The Artificial Electron Belt, October 1963 to October 1966," in "Earth's Particles and Fields", B. M. McCormac, ed., 1968, pp. 57-63, Reinhold Book Corp., New York.
28. D. J. Williams, J. F. Arens, and L. J. Lanzerotti, "Observations of Trapped Electrons at Low and High Altitudes," J. Geophys. Res., Vol. 73, 1968, pp. 5673-5696.
29. D. J. Williams and C. O. Bostrom, "Proton Entry into the Magnetosphere on May 26, 1967," J. Geophys. Res., Vol. 74, 1969, pp. 3019-3026.
30. T. A. Potemra, A. J. Zmuda, C. R. Haave, and B. W. Shaw, "VLF Phase Disturbances, H. F. Absorption, and Solar Protons in the Events of August 28 and September 2, 1966," J. Geophys. Res., Vol. 74, 1969, pp. 6444-6458.

Table C-2 (Continued)

Publications Based on Satellite 5E Data

31. C. O. Bostrom, D. S. Beall, and J. C. Armstrong, "Time History of the Inner Radiation Zone, October 1963 to December 1968," J. Geophys. Res., Vol. 75, 1970, pp. 1246-1256.
32. J. C. Armstrong, D. S. Beall, and C. O. Bostrom, "Response of Electrons ( $E_e \geq 0.28$  Mev) at  $1.2 \leq L \leq 1.3$  to the November 1968 Magnetic Storm," World Data Center A Report UAG-8, Vol. II, 1970.
33. C. O. Bostrom, "Entry of Low Energy Solar Protons into the Magnetosphere," Intercorrelated Satellite Observations Related to Solar Events, V. Manno and D. E. Page (eds.), pp. 229-238, 1970, D. Reidel Publishing Co., Dordrecht-Holland.
34. A. J. Zmuda, J. C. Armstrong, and F. T. Heuring, "Characteristics of Transverse Magnetic Disturbances Observed at 1100 Kilometers in the Auroral Oval," J. Geophys. Res., Vol. 75, 1970, pp. 4757-4762.
35. J. C. Armstrong and A. J. Zmuda, "Field-Aligned Current at 1100 Km in the Auroral Region Measured by Satellite," J. Geophys. Res., Vol. 75, 1970, pp. 7122-7127.
36. T. A. Potemra, A. J. Zmuda, B. W. Shaw, and C. R. Haave, "VLF Phase Disturbances, HF Absorption, and Solar Protons in the PCA Events of 1967," Radio Science, Vol. 5, 1970, pp. 1137-1145.
37. T. A. Potemra and L. J. Lanzerotti, "Equatorial and Precipitating Solar Protons in the Magnetosphere, 2. Riometer Observations," J. Geophys. Res., Vol. 76, 1971, pp. 5244-5251.
38. T. A. Potemra, "The Empirical Connection of Riometer Absorption to Solar Protons During PCA Events," Radio Science, Vol. 7, 1972, pp. 571-577.
39. A. J. Zmuda and T. A. Potemra, "Bombardment of the Polar-Cap Ionosphere by Solar Cosmic Rays," Rev. Geophys. and Space Phys., Vol. 10, 1972, pp. 981-991.

Table C-2 (Concluded)

Publications Based on Satellite 5E Data

40. T. A. Potemra and A. J. Zmuda, "Solar Electrons and Alpha Particles During Polar-Cap Absorption Events," J. Geophys. Res., Vol. 77, 1972, pp. 6916-6921.
41. D. J. Williams and F. T. Heuring, "Strong Pitch Angle Diffusion and Magnetospheric Solar Protons," J. Geophys. Res., Vol. 78, 1973, pp. 37-50.
42. A. J. Zmuda and T. A. Potemra, "HF Absorption Near the Polar-Cap Edge during PCA Events," J. Geophys. Res., Vol. 78, 1973, pp. 5818-5821.
43. J. C. Armstrong, "Field Aligned Currents in the Magnetosphere," Proceedings of the Summer Advanced Study Institute, "Earth's Particles and Fields," Sheffield, England, August 13-24, 1973.



Table C-3  
DODGE Satellite Bibliography

1. R. E. Fischell, "Spin Control of Earth Satellites," APL Technical Digest, September-October 1965, pp. 8-14.
2. P. M. Bainum, D. K. Anand, and D. L. Mackison, "Perturbations and Lyapunov Stability of a Multiple Connected Gravity-Gradient Satellite at Synchronous Altitude," Fifth U. S. National Congress of Applied Mechanics, Minneapolis, Minnesota, June 1966.
3. R. E. Fischell, "The DODGE Satellite," AIAA/JACC Guidance and Control Conference, Seattle, Washington, August 15-17, 1966.
4. V. L. Pisacane, "Three-Axis Stabilization of Dumbbell Satellite by a Small Constant-Speed Rotor," APL/JHU Report, TG-855, October 1966.
5. R. E. Fischell and R. B. Kershner, "Attitude Stabilization Experiments with the DODGE Spacecraft," Proc. XVII Cong. Int. Astronau. Fed., Madrid, October 1966.
6. P. M. Bainum, "On the Motion and Stability of a Multiple Connected Gravity-Gradient Satellite with Passive Dumping," Ph.D. dissertation, The Catholic University of America, December 1966; also APL/JHU Report TG-872, January 1967.
7. D. L. Mackison, "Analysis of Time Delay Magnetic Damping of Spacecraft Librations in Near-Synchronous Equatorial Orbits," APL/JHU Report TG 916, June 1967.
8. V. L. Pisacane, W. H. Guier, and P. P. Pardoe, "Dynamical Equations for the Position and Attitude of a Spacecraft with Time Dependent Mass and Mass Properties," APL/JHU Report TG-919, June 1967.
9. V. L. Pisacane, P. P. Pardoe, and B. J. Hook, "Stabilization System Analyses and Performance of the GEOS-A Gravity-Gradient Satellite," AIAA/JACC Guidance and Control Conf., Seattle, August 1966; also Journal of Spacecraft and Rockets, 4 (12), pp. 1623-1630, 1967.

Table C-3 (Concluded)  
DODGE Satellite Bibliography

10. F. F. Mobley, "Gravity-Gradient Stabilization Results from the DODGE Satellite," American Institute of Aeronautics and Astronautics Satellite Systems Conference, San Francisco, California, April 8-10, 1968, Paper 68-460.
11. P. M. Bainum and D. L. Mackison, "Gravity-Gradient Stabilization of Synchronous Orbiting Satellites," The British Interplanetary Society Spring Meeting, Loughborough, England, April 1967; also JBIS, December 1968.
12. R. A. Matthey and J. F. Smola, "DODGE Gravity-Gradient Boom Thermal Bending Experiment," APL/JHU Report TG-1079, August 1969.
13. J. M. Whisnant and V. L. Pisacane, "Comparison of Theoretical and Experimental Attitude Data for the DODGE Spacecraft", APL/JHU Report TG-1076, August 1969.
14. R. E. Fischell and F. F. Mobley, "Gravity-Gradient Stabilization Studies with the DODGE Satellite," American Institute of Aeronautics and Astronautics Aerospace Sciences Meeting, New York, New York, January 19-21, 1970, Paper 70-69.

**SUPPLEMENTARY**

**INFORMATION**



THE JOHNS HOPKINS UNIVERSITY  
APPLIED PHYSICS LABORATORY

Johns Hopkins Road, Laurel, Maryland 20810  
Telephone: (301) 953-7100 and 792-7800

Please refer to:  
TSSD-5369.2

AD- A066299

Defense Technical Information Center  
Cameron Station  
Alexandria, Virginia 22314

Subject: Transmittal of Technical Information for  
APL/JHU SDO 1600

Enclosure: (1) New and revised pages for APL/JHU SDO 1600,  
Artificial Earth Satellites Designed and  
Fabricated by the Johns Hopkins University  
Applied Physics Laboratory

Please insert the attached new pages that describe the  
Magnetic Field Satellite (MAGSAT) in your copy of Artificial  
Earth Satellites Designed and Fabricated by JHU/APL. Front  
matter is also attached; the old material should be discarded.  
Requests for additional copies of the manual, or for addi-  
tional copies of this supplement, should be addressed to:

Applied Physics Laboratory  
The Johns Hopkins University  
Johns Hopkins Road  
Laurel, MD 20810

Attn: J. R. Champion

Additions to the subject document will continue to be  
issued from time to time. To assure receipt of these changes,  
addressees should report changes in the name or address of  
each holder of the publication.

Very truly yours,

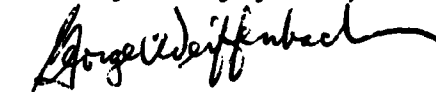
  
George C. Weiffenbach  
Space Department Head

GCW:JRC:SJD:dw  
Attachments

CONTENTS

List of Illustrations . . . . .	ix
List of Tables . . . . .	xiii
Introduction . . . . .	1
Historical Note . . . . .	7
I. NAVIGATION SATELLITES	
Satellite 1-A . . . . .	I-1
Background . . . . .	I-3
Physical Characteristics	I-3
Features . . . . .	I-3
Objectives . . . . .	I-5
Achievements . . . . .	I-5
Satellite 1-B . . . . .	I-7
Physical Characteristics . . . . .	I-9
Features . . . . .	I-9
Objectives . . . . .	I-9
Achievements . . . . .	I-11
Satellite 2-A . . . . .	I-13
Physical Characteristics . . . . .	I-15
Features . . . . .	I-15
Objectives . . . . .	I-15
Achievements . . . . .	I-17
Satellite 3-A . . . . .	I-19
Physical Characteristics . . . . .	I-21
Features . . . . .	I-21
Objectives . . . . .	I-21
Satellite 3-B . . . . .	I-23
Physical Characteristics . . . . .	I-25
Features . . . . .	I-25
Objectives . . . . .	I-27
Achievements . . . . .	I-27

CONTENTS (Continued)

Satellites 4-A and 4-B . . . . .	I-29
Background . . . . .	I-31
Physical Characteristics . . . . .	I-31
Features . . . . .	I-32
Objectives . . . . .	I-32
Achievements . . . . .	I-32
Satellite 5A Series . . . . .	I-39
(5A-1, 5A-2, and 5A-3)	
Background . . . . .	I-41
Physical Characteristics . . . . .	I-42
Features . . . . .	I-42
Objectives . . . . .	I-42
Achievements . . . . .	I-45
Satellite 5BN Series . . . . .	I-47
(5BN-1, 5BN-2, and 5BN-3)	
Background . . . . .	I-49
Physical Characteristics . . . . .	I-49
Features . . . . .	I-50
Objectives . . . . .	I-50
Achievements . . . . .	I-50
Satellite 5C-1 . . . . .	I-55
Physical Characteristics . . . . .	I-57
Features . . . . .	I-57
Objectives . . . . .	I-60
Achievements . . . . .	I-60
Oscar Satellite Series . . . . .	I-61
(Oscars 4, 6, and 8-14)	
Background . . . . .	I-64
Physical Characteristics . . . . .	I-64
Features . . . . .	I-64
Objective . . . . .	I-69
Achievements . . . . .	I-69
TRIAD Satellite . . . . .	I-71
Background . . . . .	I-73
Physical Characteristics . . . . .	I-73
Features . . . . .	I-73
Objectives . . . . .	I-77
Achievements . . . . .	I-78

CONTENTS (Continued)

TIP-II and -III Satellites . . . . .	I-81
Background . . . . .	I-83
Physical Characteristics . . . . .	I-83
Features . . . . .	I-84
Objectives . . . . .	I-88
Achievements . . . . .	I-88
Translator Satellite (TRANSAT) . . . . .	I-91
Background . . . . .	I-93
Description . . . . .	I-93
Physical Characteristics . . . . .	I-93
Features . . . . .	I-96
Objectives . . . . .	I-99
Achievements . . . . .	I-99
 II. GEODETIC RESEARCH SATELLITES	
ANNA-1A and -1B Satellites . . . . .	II-1
Background . . . . .	II-3
Physical Characteristics . . . . .	II-3
Features . . . . .	II-3
Objectives . . . . .	II-6
Achievements . . . . .	II-6
GEOS-A and -B Satellites . . . . .	II-9
Background . . . . .	II-11
Physical Characteristics . . . . .	II-11
Features . . . . .	II-11
Geodetic Instrumentation . . . . .	II-14
Objectives . . . . .	II-15
Achievements . . . . .	II-15
LIDOS Satellite . . . . .	II-17
Background . . . . .	II-19
Physical Characteristics . . . . .	II-19
Features . . . . .	II-19
Objectives . . . . .	II-20
Achievements . . . . .	II-20
GEOS-C Satellite . . . . .	II-23
Background . . . . .	II-25
Physical Characteristics . . . . .	II-25
Features . . . . .	II-25
Objectives . . . . .	II-28
Achievements . . . . .	II-30

CONTENTS (Continued)

III. ORBITAL ENVIRONMENT AND DYNAMICS  
RESEARCH SATELLITES

TRAAC Satellite . . . . .	III-1
Background . . . . .	III-3
Physical Characteristics . . . . .	III-3
Features . . . . .	III-3
Objectives . . . . .	III-5
Achievements . . . . .	III-5
Satellite 5E Series . . . . .	III-7
(5E-1, 5E-2, 5E-3, and 5E-5)	
Background . . . . .	III-9
Physical Characteristics . . . . .	III-9
Features . . . . .	III-10
Objectives . . . . .	III-16
Achievements . . . . .	III-18
DODGE Satellite . . . . .	III-23
Background . . . . .	III-25
Physical Characteristics . . . . .	III-25
Features . . . . .	III-25
Objectives . . . . .	III-28
Achievements . . . . .	III-28
Magnetic Field Satellite (MAGSAT) . . . . .	III-33
Background . . . . .	III-35
Physical Characteristics . . . . .	III-35
Features . . . . .	III-37
Objectives . . . . .	III-40
Achievements . . . . .	III-41

IV. IONOSPHERIC RESEARCH SATELLITES

Beacon Explorer Satellites . . . . .	IV-1
(BE-A, BE-B, and BE-C)	
Background . . . . .	IV-3
Physical Characteristics . . . . .	IV-3
Features . . . . .	IV-4
Objectives . . . . .	IV-4
Achievements . . . . .	IV-7



CONTENTS (Concluded)

DME-A Satellite . . . . .	IV-9
Background . . . . .	IV-11
Physical Characteristics . . . . .	IV-11
Features . . . . .	IV-11
Objectives . . . . .	IV-12
Achievements . . . . .	IV-12
P76-5 Satellite . . . . .	IV-13
Background . . . . .	IV-15
Physical Characteristics . . . . .	IV-15
Features . . . . .	IV-15
Objectives . . . . .	IV-18
Achievements . . . . .	IV-18

V. ASTRONOMICAL EXPLORATION SATELLITES

SAS-A and -B Satellites . . . . .	V-1
Background . . . . .	V-3
Physical Characteristics . . . . .	V-3
Features (Control Section) . . . . .	V-3
Objectives . . . . .	V-6
Achievements . . . . .	V-7
SAS-C Satellite . . . . .	V-9
Background . . . . .	V-11
Physical Characteristics . . . . .	V-11
Features . . . . .	V-13
Objectives . . . . .	V-13
Achievements . . . . .	V-15

APPENDIXES

A. Definitions and Abbreviations . . . . .	A-3
B. The Navy Navigation Satellite System . . . . .	B-1
C. Bibliography . . . . .	C-1

ILLUSTRATIONS

I-1	Satellite 1-A, Launch Configuration . . .	I-2
I-2	Satellite 1-A, Cutaway View . . . . .	I-4
I-3	Satellite 1-B, Artist's Concept . . . . .	I-8
I-4	Satellite 1-B, Cutaway View . . . . .	I-10
I-5	Satellite 2-A . . . . .	I-14
I-6	Satellite 2-A, Cutaway View . . . . .	I-16
I-7	Satellite 3-A . . . . .	I-20
I-8	Satellite 3-A, Cutaway View . . . . .	I-22
I-9	Satellite 3-B and LOFTI Pickaback Satellite . . . . .	I-24
I-10	Satellite 3-B, Cutaway View . . . . .	I-26
I-11	Satellite 4-A . . . . .	I-30
I-12	Satellite 4-A, Cutaway View . . . . .	I-33
I-13	Satellite 4-A and Pickaback Satellites . . . . .	I-35
I-14	Satellite 4-B . . . . .	I-36
I-15	Satellite 4-B, Cutaway View . . . . .	I-37
I-16	Satellite 5A-1, Artist's Concept . . . . .	I-40
I-17	Satellite 5A-2 on Vibration Test Table . . . . .	I-43
I-18	Satellite 5A (Typical), Orbit Configuration) . . . . .	I-44
I-19	Satellite 5BN-1, Artist's Concept . . . . .	I-48
I-20	Satellite 5BN-1, Artist's Concept . . . . .	I-51
I-21	Satellite 5BN-2 Atop Satellite 5E-3 . . . . .	I-52
I-22	Satellite 5C-1, Artist's Concept . . . . .	I-56
I-23	Satellite 5C-1, Cutaway View . . . . .	I-58

ILLUSTRATIONS (Continued)

I-24	Satellite 5C-1 During Vibration Test . . . . .	I-59
I-25	Operational (Oscar) Navy Navigation Satellite, Artist's Concept . . . . .	I-62
I-26	Oscar 4 Satellite . . . . .	I-65
I-27	Interior View of Navy Navigation Satellite (Oscar 6) . . . . .	I-66
I-28	NNS (Oscar 15) Simplified Functional Block Diagram . . . . .	I-67
I-29	TRIAD Satellite, Artist's Concept . . . . .	I-72
I-30	TRIAD Satellite System Block Diagram . . . . .	I-74
I-31	DISCOS, Cutaway View . . . . .	I-76
I-32	TIP Satellite, Artist's Concept . . . . .	I-82
I-33	TIP Satellite System Block Diagram . . . . .	I-85
I-34	Single-Axis DISCOS . . . . .	I-87
I-35	TRANSAT, Artist's Concept . . . . .	I-92
I-36	TRANSAT in SATRACK/Range Safety Test Configuration . . . . .	I-95
I-37	TRANSAT Functional Block Diagram . . . . .	I-97
II-1	ANNA-1B Satellite, Artist's Concept . . . . .	II-2
II-2	ANNA-1A Satellite . . . . .	II-4
II-3	ANNA-1B Satellite, Cutaway View . . . . .	II-5
II-4	ANNA-1B Optical Beacon Test . . . . .	II-7
II-5	GEOS-A Satellite, Artist's Concept . . . . .	II-10
II-6	GEOS-B Satellite, Artist's Concept . . . . .	II-12
II-7	GEOS-B Satellite, Cutaway View . . . . .	II-13
II-8	LIDOS Satellite, Artist's Concept . . . . .	II-18

ILLUSTRATIONS (Continued)

II-9	LIDOS Launch Sequence . . . . .	II-22
II-10	GEOS-C Satellite, Artist's Concept . . . . .	II-24
II-11	GEOS-C Cutaway View . . . . .	II-26
II-12	GEOS-C Satellite Subsystems Block Diagram . . . . .	II-27
II-13	GEOS-C Calibration Configuration . . . . .	II-29
II-14	Satellite-to-Satellite Experiment Configuration . . . . .	II-29
III-1	TRAAC Satellite . . . . .	III-2
III-2	TRAAC Satellite, Cutaway View . . . . .	III-4
III-3	Satellite 5E-1, Artist's Concept . . . . .	III-8
III-4	Satellite 5E-3, Artist's Concept . . . . .	III-11
III-5	Satellite 5E-5, Artist's Concept . . . . .	III-12
III-6	Satellite 5E-1, Cutaway View . . . . .	III-13
III-7	Satellite 5E-2, Cutaway View . . . . .	III-14
III-8	Satellite 5E-5 . . . . .	III-17
III-9	DODGE Satellite, Artist's Concept . . . . .	III-24
III-10	DODGE Satellite During Sunlight Tests . . . . .	III-26
III-11	Earth as Photographed from DODGE Satellite on 23 September 1968 . . . . .	III-31
III-12	MAGSAT, Artist's Concept . . . . .	III-34
III-13	MAGSAT Orbital Configuration . . . . .	III-36
III-14	MAGSAT Functional Block Diagram . . . . .	III-38
III-15	MAGSAT Instrumentation and Features . . . . .	III-39
IV-1	BE-A Satellite, Artist's Concept . . . . .	IV-2
IV-2	BE-A Satellite, Cutaway View . . . . .	IV-5

ILLUSTRATIONS (Concluded)

IV-3	BE-A Satellite, Exploded View . . . . .	IV-6
IV-4	DME-A Satellite . . . . .	IV-10
IV-5	P76-5 Satellite, Artist's Concept . . . . .	IV-14
IV-6	P76-5 Spacecraft Orbital Configuration . . . . .	IV-16
IV-7	P76-5 Satellite Simplified Block Diagram . . . . .	IV-17
V-1	SAS-A Satellite, Artist's Concept . . . . .	V-2
V-2	SAS-A Liftoff from San Marco Equatorial Range . . . . .	V-4
V-3	SAS-B Satellite, Artist's Concept . . . . .	V-5
V-4	SAS-C Satellite, Artist's Concept . . . . .	V-10
V-5	SAS-C Satellite Mounted on Spin Table . . . . .	V-12
V-6	SAS-C Control Section and Orbital Configuration . . . . .	V-14
B-1	Navy Navigation Satellite System . . . . .	B-2
B-2	Navy Navigation Satellites in Polar Orbit with 45° Nodes . . . . .	B-3
B-3	Integrated Doppler Measurement . . . . .	B-7
B-4	Doppler Frequency Variation with Time . . . . .	B-8
B-5	Organization of Satellite Message . . . . .	B-12
B-6	Detected Signal Characteristics . . . . .	B-13
B-7	Typical Two-Minute Message Printout . . . . .	B-15
B-8	Satellite Word Code Format . . . . .	B-16

TABLES

1	APL Designed and Fabricated Satellites, Designations and Nominal Orbit Data . . . . .	4
I-1	Oscar Satellite Orbits . . . . .	I-63
I-2	Oscar Satellite Features . . . . .	I-68
I-3	Oscar Satellite RMS Oscillator Stabilities . . . . .	I-69
I-4	TRIAD Satellite Features . . . . .	I-75
I-5	TIP Satellite Features . . . . .	I-86
C-1	Navy Navigation Satellite System Bibliography . . . . .	C-1
C-2	Publications Based on Satellite 5E Data . . . . .	C-8
C-3	DODGE Satellite Bibliography . . . . .	C-13

Table 1 (Concluded)  
 APL Designed and Fabricated Satellites, Designations and Nominal Orbit Data\*

Common Name <sup>(1)</sup>	Catalog Number	Satellite Designation		Launch Date	Offset and Frequencies <sup>(2)</sup>	Inclination	Orbit Data <sup>(3)</sup>	Apogee/Perigee	Ceased Transmitting
		APL	International - NWL						
O 13	02807	30130	1967 48A	5/18/67	-80 Z	89.6	107	1104/ 1067	-
DODGE	02867	01167	1967 66F	7/ 1/67	-20 (240 MHz)	5.2	1319	33650/33243	-
O 14	02965	30140	1967 92A	9/25/67	-80 Z	89.2	107	1114/ 1040	-
GEOS B	03093	01168	1968 02A	1/11/68	-50 Y, T	105.8	112	1581/ 1078	-
LIDOS				8/16/68		(Failed to Orbit)			
SAS A	04797	-	1970 107A	12/12/70	-	03	94.8	532/502	4/11/73
TRIAD	06173	01172	1972 69A	9/ 2/72	-84/-145 Z	90.1	101	810/728	-
SAS B	06282	-	1972 91A	11/15/72	-	01.9	95	608/439	-
GEOS C	07734	01175	1975 27A	4/9/75	-	114.9	101.7	849/838	-
SAS C	07788	-	1975 37A	5/7/75	-	2.99	94.9	517/510	-
TIP II	08361	30460	1975 99A	10/12/75	-80/-145 Z	90.38	98.8	830/ 580	-
P76 5	08860	30900	1976 47A	5/22/76	-141.5 Z	99.67	105.6	1084/ 990	-
TIP III	09403	30470	1976 89A	9/ 1/76	-80/-145 Z	89.29	97.9	867/ 452	-
O 11/TRANSAT	10457	30110	1977 106A	10/28/77	-80 Z/-140	89.92	107	1108/1069	-
MAGSAT	11604	-	1979 084A	10/30/79	-50 Y	96.8	91	352/578	6/11/80

\* Footnotes

- Abbreviations: O = Oscar (Operational Navy Navigation Satellite, formerly Transit); DODGE = Department of Defense Gravity Experiment; GEOS = Geodetic Earth Orbiting Satellite; LIDOS = Low Inclination Doppler Only Satellite; SAS = Small Astronomy Satellite; GEOS C = Geodynamics Experimental Ocean Satellite; TIP = Transit Improvement Program; TRANSAT = Translator Satellite; MAGSAT = Magnetic Field Satellite.
- Doppler frequencies only; legend: A = 54/108 MHz, B = 162/216 MHz, C = 54/324 MHz, T = 324/972 MHz, Y = 162/324 MHz, Z = 150/400 MHz; Offset in ppm.
- Inclination in degrees from equator; Period in minutes, Apogee/Perigee in kilometers (approx.)

THE JOHNS HOPKINS UNIVERSITY  
APPLIED PHYSICS LABORATORY  
LAUREL, MARYLAND

SDO 1600  
August 1980

MAGNETIC FIELD SATELLITE (MAGSAT)  
(1979 094A)



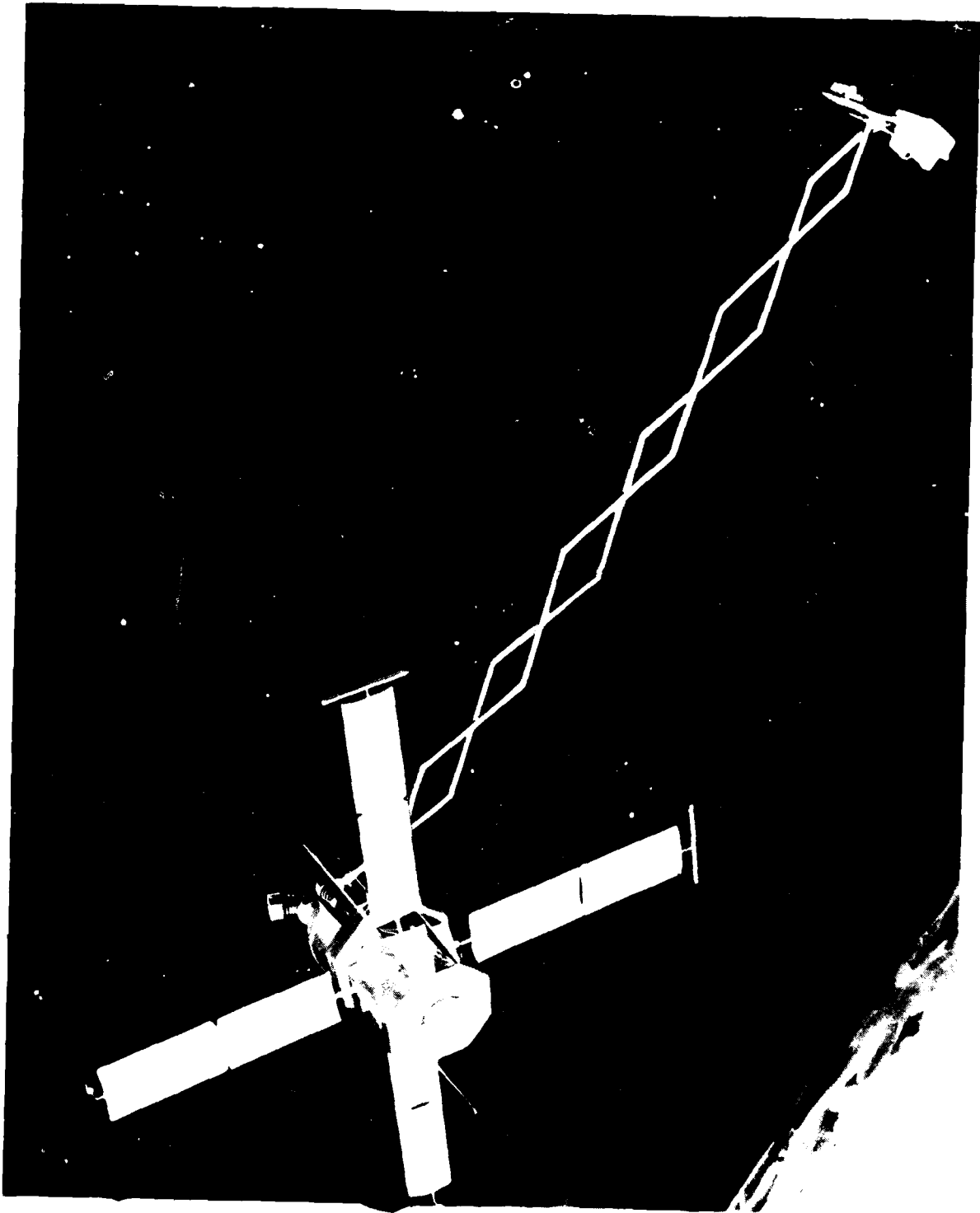

Fig. III-12 MAGSAT, Artist's Concept.

MAGNETIC FIELD SATELLITE (MAGSAT)

Launch: 30 October 1979; Vandenberg AFB, California  
Vehicle: Scout-D (four stage, solid fuel)  
Orbit: Apogee 352 km, perigee 578 km, inclinations 96.8°  
Remarks: Despin, solar panel deployment, 4th stage separation, stabilization, and magnetometer boom extension normal; orbit achieved was essentially as desired.

Background

Developed in support of the NASA Resource Observation Program, MAGSAT (Fig. III-12) was fabricated at APL substantially below projected cost by the use of surplus parts from other satellite programs and the use of a base module of the SAS-C design. The principal user of MAGSAT data was the U.S. Geological Survey (USGS); however, a number of MAGSAT studies were conducted by investigators from both U.S. and foreign governments, universities, and industry.

Physical Characteristics (Fig. III-13)

o Body: Base module - Irregular 66 cm diameter polygon by 61 cm high; total height (including instrument module), 163.8 cm.

o Appendages: (1) Extendable dual scissors boom 6.02 m long for separating the sensor platform from the magnetic fields of the instrument and base modules, for positioning the platform such that its angular deviation relative to the attitude transfer system (ATS) optical axis is maintained within 3 arc minutes, and for centering the magnetometer base plane mirror such that the geometric center coincides with the ATS optical axis; (2) an aerodynamic trim boom consisting of a motorized 1.27 cm diameter tubular element, about 12.2 m long, to provide a variable length surface for balancing yaw aerodynamic torques; and (3) four double-hinged solar panels with a total of 1200 cells.

o Weight: 183 kg.

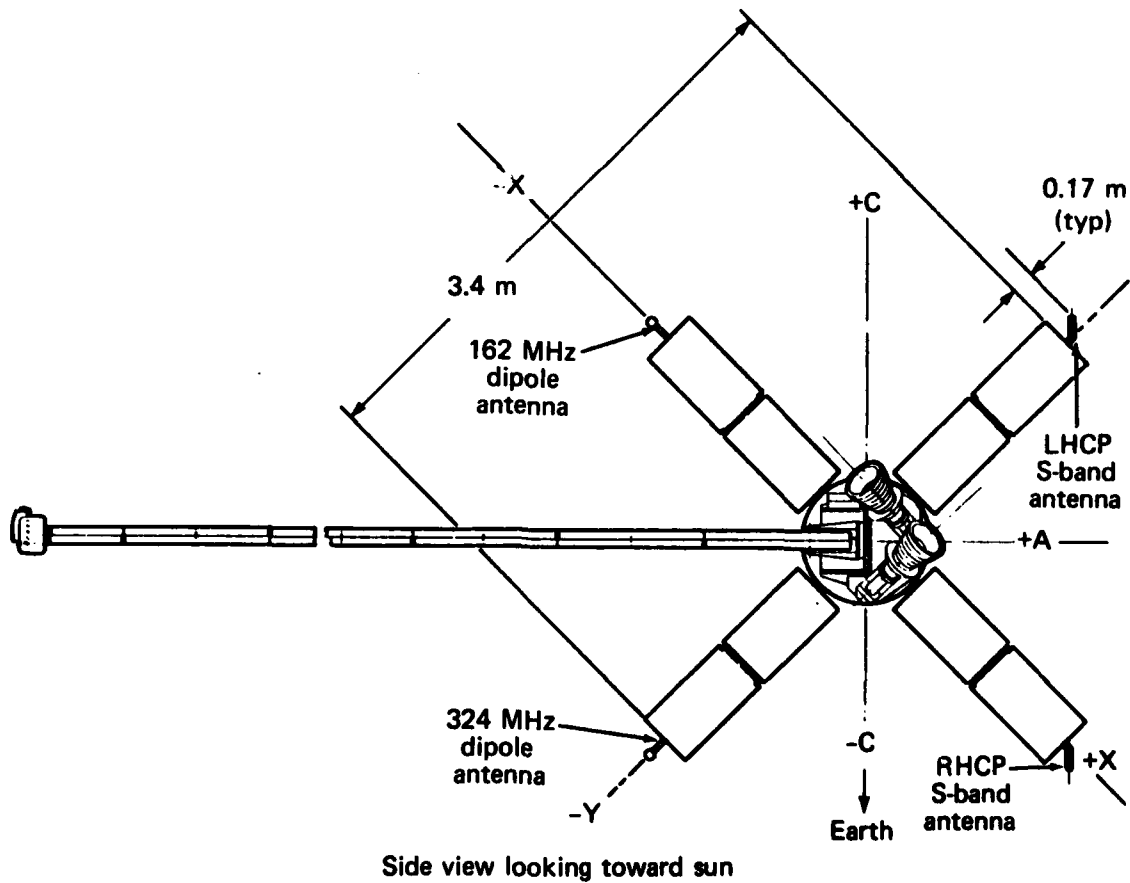
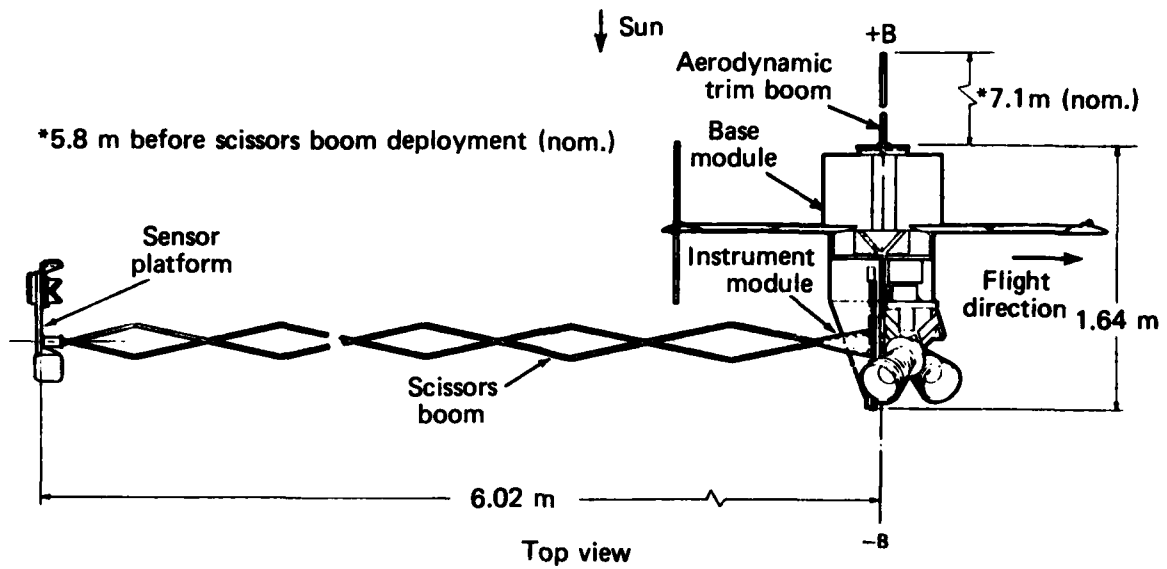

Fig. III-13 MAGSAT Orbital Configuration.

## Features

A simplified system block diagram of MAGSAT is shown in Fig. III-14; the main satellite features are shown in Fig. III-15. The sensor platform three axis vector magnetometer, provided by GSFC, operates on the fluxgate principle and uses three ring-core sensors mounted on a ceramic structure for mechanical stability. The sensor responds to fields in the range of  $\pm 64,000$  gamma (1 gamma =  $10^{-5}$  gauss) with an accuracy of  $\pm 2$  gamma. Each of the three vector sensors samples the field 16 times per second to a precision of 0.5 gamma.

The cesium vapor scalar magnetometer was developed for MAGSAT by Ball Brothers, Inc. and Varian of Canada. Two cesium vapor lamps excited by RF at 110 MHz, and four glass cells with cesium vapor in an arrangement for closed-loop optical pumping, are used to produce an output signal proportional to the magnitude of the field to an accuracy of  $\pm 1$  gamma. The sensor output is sampled eight times per second.

**Power System:** Solar cells with Ni-Cd batteries provide average power of 120 to 160 W. The system includes a redundant shunt regulator for shunting excessive solar array power and a controlling battery current and voltage limiter (BCVL), a low voltage sensing switch (LVSS), and several dc/dc converters and regulators for power conditioning.

**Telemetry:** Pulse-code modulated (PCM) system including a dual oscillator and divider, format generator, multiplexer and encoder, recorder/transponder interface, two 16-channel digital and three 64-channel analog subcommutators, and main analog commutator. The system interfaces with the doppler system, two NASA standard transponders, two tape recorders, and the scientific instruments and other satellite subsystems. Operating modes are (1) transmission of playback data plus real-time data, and (2) transmission of real-time data only.

**Attitude Control:** A momentum wheel oriented transverse to the flight direction provides gyrostability. An IR scanner, integrated with the wheel, detects the earth horizon and measures the satellite pitch angle to an accuracy of  $\pm 1$  degree. The pitch angle signal is used for closed-loop control of pitch by modulation of the wheel speed. Roll and yaw controlled to  $\pm 5$  degrees by operation of a Z axis magnetic torquing coil with roll sensed by the IR scanner. Momentum wheel speed maintained at  $1500 \pm 200$  rpm by automatic momentum dumping using X and Y coils driven in quadrature by signals from X and Y magnetometers,

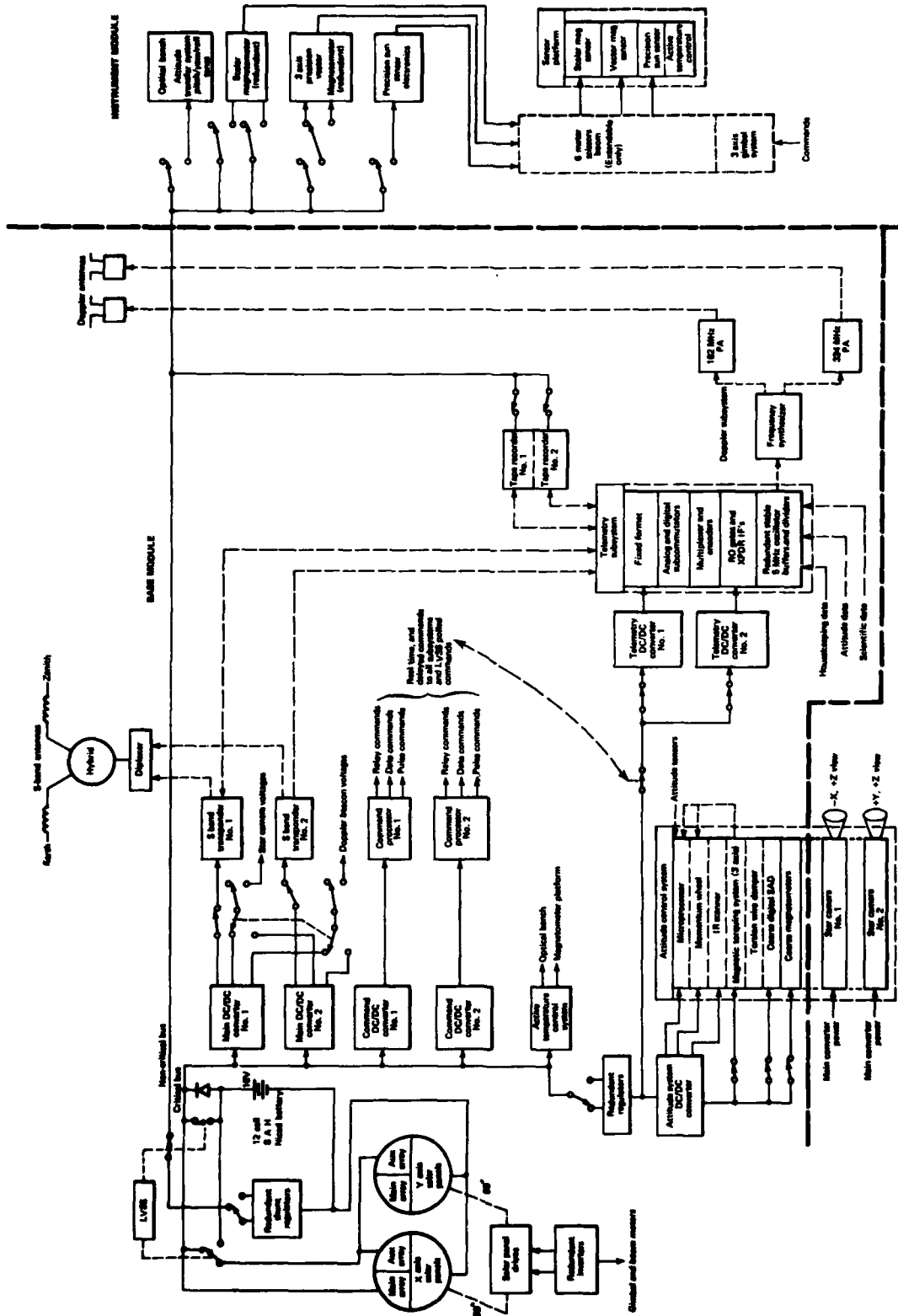
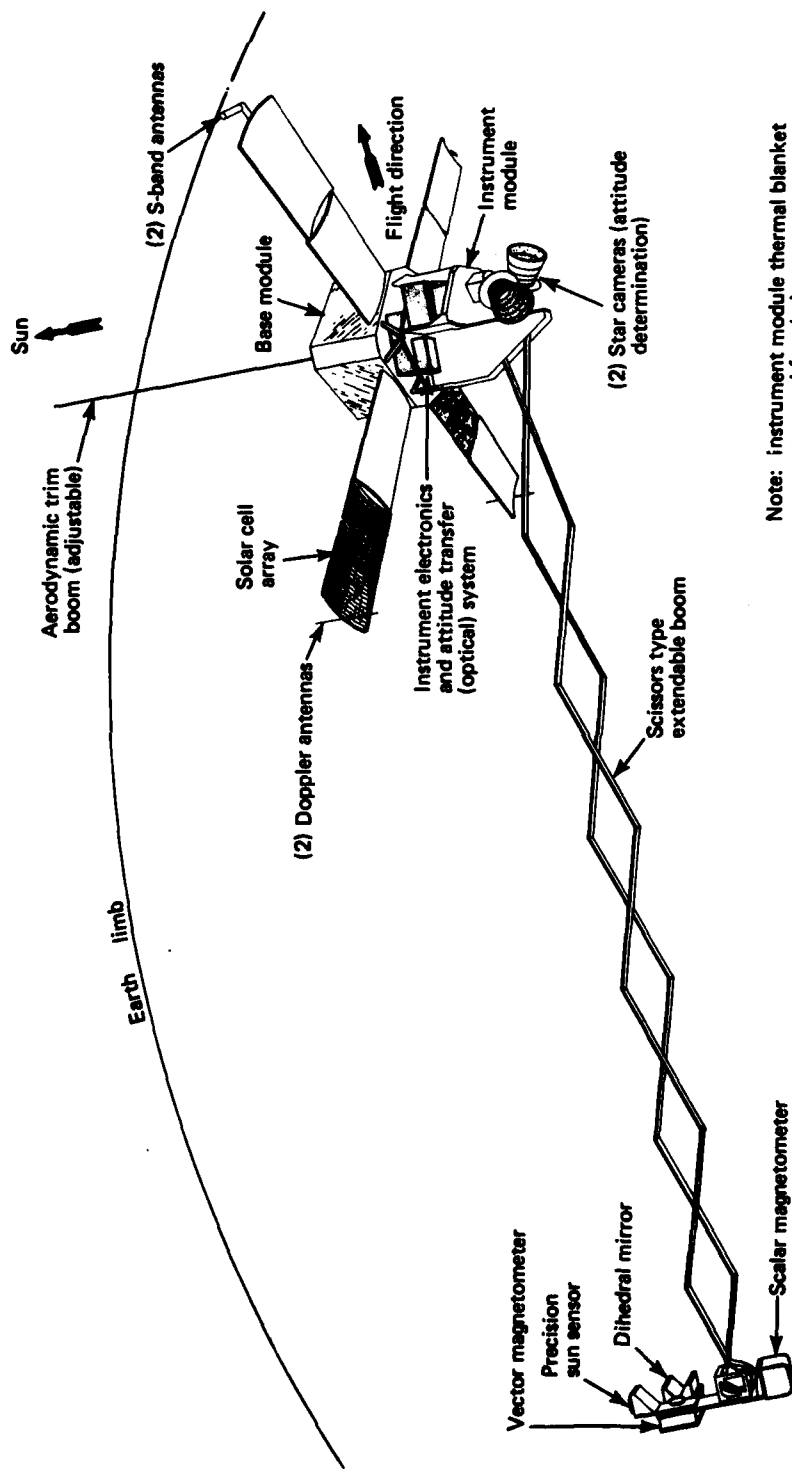

Fig. III-14 MAGSAT Functional Block Diagram.



Note: instrument module thermal blanket removed for clarity

Fig. III-15 MAGSAT Instrumentation and Features.

all regulated by on-board microprocessor system. An aerotrim system with extendable boom used to reduce residual aerodynamic torques in yaw.

**Attitude Determination:** Three-axis vector magnetometer, coarse sun sensor, and infrared horizon scanner provide coarse attitude data accurate to within 1 degree. Two star cameras, a precision sun sensor, a rate gyro, and an attitude transfer system provide high-accuracy attitude data with an accuracy of 12 arc-seconds rms.

**Command System:** The microprocessor based system executes relay, pulse, and data commands on a real-time and on a delayed basis and provides semiautonomous attitude, power, and telemetry system operations. Fully redundant (except for the antenna) S-band transponders process uplink phase shift keying (PSK) command modulation and output command data to the associated command processors. A command is handled by both processors, but executed by only one command processor. Each processor accommodates 82 delayed commands. All commands are error protected by a special code.

**Doppler Beacon System:** Dual oven-controlled 5 MHz ultra-stable quartz crystal oscillators, both with an offset of -50 ppm. The outputs are synthesized and transmitted at 162 and 324 MHz (0.25 and 0.4 W, respectively) to provide the doppler data for satellite tracking.

**Thermal Control:** Instrument and base modules coupled thermally by conduction and radiation, with the base module control system consisting of four sets of thermostatically controlled louvers which control the flow of heat to four space radiators. Three passive radiators also used on the instrument module. All radiators coated with silver Teflon, except for one which is painted white, and remaining exterior surfaces are covered with multilayer insulation to direct heat flow to radiator. Precise control ( $25^{\circ}\text{C} \pm 0.5^{\circ}\text{C}$ ) of critical components provided by electric heaters.

### Objectives

A major MAGSAT program objective was to make a global survey of the three vector components of the earth's magnetic field, with individual components determined to an accuracy of 6-gamma rrs at the satellite altitude and 20-gamma rrs at the earth's surface. Other program objectives were:

1. Provide data and a worldwide magnetic-field model suitable for the USGS to use in updating and refining both world and regional magnetic charts.
2. Compile a global scalar and vector crustal magnetic anomaly map to an accuracy of 3-gamma rss in magnitude and 6-gamma rss in each component, and a spatial resolution of 300 km.
3. Interpret the crustal anomaly map, in conjunction with correlative data, in terms of geologic/geophysical models of the earth's crust for assessing natural resources and determining exploration strategy.

#### Achievements

After launch into a near-optimal orbit, a sequence of pre-programmed maneuvers was performed to orient the satellite properly with the sun and thus ensure sufficient solar array output. Attitude control (earth lock) was then achieved and, on 1 November 1979, the magnetometer boom was deployed. After less than one week, the satellite was in the routine data gathering mode.

All spacecraft and instrument module subsystems performed as intended, and the magnetometers returned good data. Operational lifetime, because of the low satellite altitude, was determined by aerodynamic drag. Reentry occurred on 11 June 1980, providing an appreciably longer mission lifetime than the 150 days expected.